

WWW.LEUTRON.DE

# LIGHTNING AND SURGE PROTECTION





**Leutron Catalogue 2021/2022, valid from April 2021**

With publication of the catalog 2021/2022 all previous catalogs lose their validity.

We reserve the right to make alterations in style and form in line with technical development.  
The illustrations are non-binding. We do not assume liability for mistakes of printing errors.  
Reprint, even in extracts, only with approval of the Leutron GmbH.



<b>■ Surge protection for power supply systems</b> <b>2</b>		<b>Table of contents</b> ..... <b>11</b>
Selection guide PowerPro ..... 6		SPDs power supply system AC ..... 12
Selection guide EL series ..... 8		Surge Protection for new LED Lighting Systems..... 78
Energetic coordination of surge arresters ..... 10		SPDs power supply system DC ..... 79
		Protection of PV Installations ..... 85
<b>■ Surge protection for measuring systems and automatic control devices</b> <b>100</b>		<b>Table of contents</b> ..... <b>110</b>
Selection guide for interfaces ..... 104		Pluggable SPD for MCR applications ..... 111
Surge protection for danger detection system ..... 108		Allocation of MP modules to plug-in sockets (MP Base) ... 125
		One-piece SPD for MCR applications ..... 126
<b>■ Surge protection for information technology and telecommunication installations</b> ..... <b>138</b>		
<b>Table of contents</b> ..... <b>142</b>		SPD for telecommunication networks ..... 149
SPD for communication networks ..... 143		Surge protective devices for LSA mounting ..... 150
<b>■ Surge protection for transmitting and receiving systems</b> ..... <b>162</b>		
<b>Table of contents</b> ..... <b>164</b>		SPD with N connector/ SPD with 7/16 connector..... 168 f.
SPD with BNC/SMA/FME connector ..... 165 f.		SPD for SAT/TV/Radio applications..... 171
<b>■ EMC filter with integrated surge protection</b> ..... <b>172</b>		
<b>Table of contents</b> ..... <b>176</b>		MCR with low pass filter ..... 182
Line filter up to 200 Ampere ..... 177		
<b>■ Monitoring</b> ..... <b>194</b>		
<b>Table of contents</b> ..... <b>198</b>		Mobile Surge Generator ..... 202
<b>■ Rare-gas-filled insulation spark gaps</b> ..... <b>204</b>		
<b>Table of contents</b> ..... <b>208</b>		Safety requirements of TC 100 A and TC 500 A ..... 216
Flexible mounting ..... 209		DIN rail mounting..... 219
For hazardous area ATEX ..... 214		
<b>■ Protective devices for AC application</b> ..... <b>222</b>		
<b>Table of contents</b> ..... <b>228</b>		Arresters for Cathodic Corrosion Protection Systems..... 230
Pipeline protection..... 226		
AC-current diverter up to AC 80 Ampere ..... 229		
<b>■ Surge Protection of PV systems: Generator Connection Boxes (GAK)</b> ..... <b>232</b>		
<b>Table of contents</b> ..... <b>236</b>		Complete protection of inverter..... 244
Generator Connection Boxes ..... 237		Special editions of GAK ..... 245
Standards ..... 250		Technical Terms ..... 255
Installations remarks ..... 252		Product Register numeric ..... 259
		Product Register alphabetical ..... 264

## SURGE PROTECTION MEETS DESIGN

The multi-pole combined modular arresters for protection against lightning strikes and transient surge voltages now have an even more attractive design. In addition to their outstanding technical properties, they are pluggable and provide a clearly readable function control indication and status display. The variable installation position – the base part can be plugged in two directions – enables a flexible and cost-saving wiring.



## EASY SETUP, SECURE OPERATION:

- Easy changing of the protection module thanks to a two-part design with a vibration-resistant locking
- Remote signalling using only one signalling contact – even with 4-pole devices
- Robust and maintenance-free due to the hermetically closed rare-gas-filled isolating spark gap without internal or external trigger electronics





The design allows for an easier handling.

## **SURGE PROTECTION FOR POWER SUPPLY SYSTEMS**

## TWO-PIECE PLUGGABLE SURGE PROTECTIVE DEVICES FOR AC POWER SUPPLY SYSTEMS

The product line »Leutron Power«: Powerful and standardized pluggable modules for almost every power supply system available.

Mechanical status indicator: State of the surge protective device is optically indicated

Locking function: Release of the latches by ergonomically shaped grip lugs

Protection against mismatching: Optimized installation due to arresters with coding

Remote signalling: Combined remote contact (changeover contact) optionally available

Turnable plug-in modules: They can be twisted on the basic module, thus, guaranteeing always good readability even with variable wiring

EAC certification

Vibration and Shock test standard: DIN EN 60068-2-6, IEC 60068-2

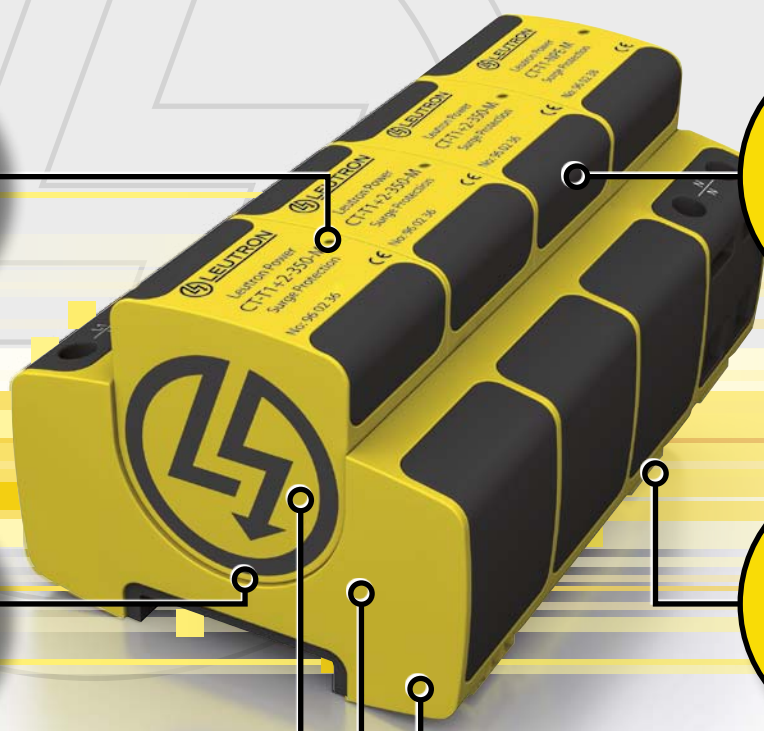



## TWO-PIECE PLUGGABLE SURGE PROTECTIVE DEVICES FOR DC POWER SUPPLY SYSTEMS

Mechanical status indicator: State of the surge protective device is optically indicated

Arrester elements available for 600 V and 1,000 V applications

Safety for PV installations: Disconnection function in case of overloads optimized for photovoltaic systems

Remote signalling: Combined remote contact (changeover contact) optionally available

EAC certification

Vibration and Shock test standard: DIN EN 60068-2-6, IEC 60068-2



3 PHASE POWER SUPPLY SYSTEMS

Network type	Description	Adequate SPD circuit type	Basic circuit diagram
--------------	-------------	---------------------------	-----------------------

TN-S	3 phase power supply systems separated N and PE		<p>4 + 0-Circuit</p>
------	---	--	----------------------

TT/ TN-S	3 phase power supply systems separated N and PE		<p>3 + 1-Circuit</p>
----------	---	--	----------------------

TN-C	3 phase power supply systems common PEN		<p>3 + 0-Circuit</p>
------	---	--	----------------------

1 PHASE POWER SUPPLY SYSTEMS

TT/ TN-S	1 phase power supply systems separated N and PE		<p>1 + 1-Circuit</p>
----------	---	--	----------------------

TN	1 phase power supply systems L/N to PE		<p>1 + 0-Circuit</p>
----	--	--	----------------------





### Lightning current arresters type 1 (class I) PowerPro B at the LPZ transition point OA-1\*

### Combined arrester type 1+2 (V wiring) PowerPro BC at the LPZ transition point OA-2\*

### Combined arrester type 1+2+3 PowerPro BCD at the LPZ transition point OA-2\*

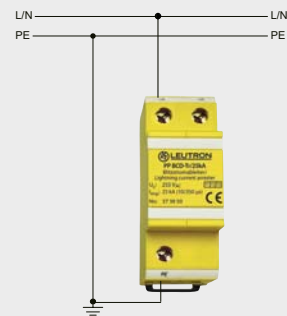
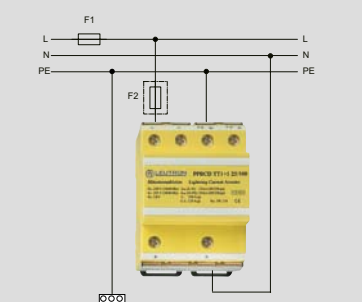
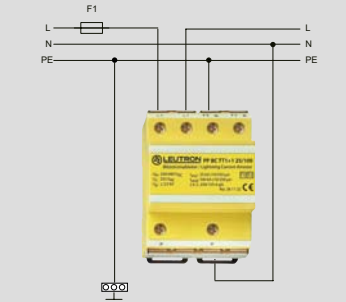
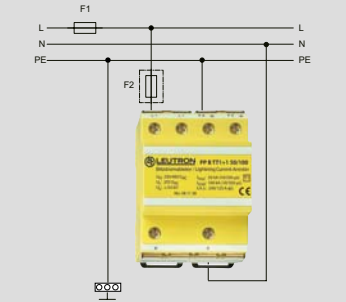
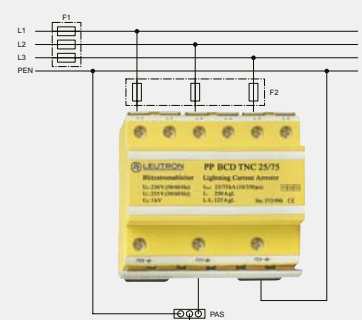
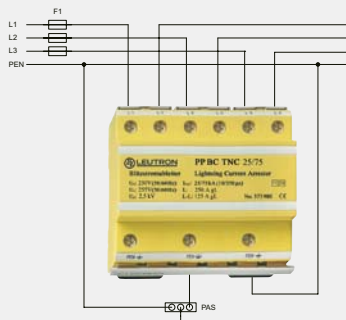
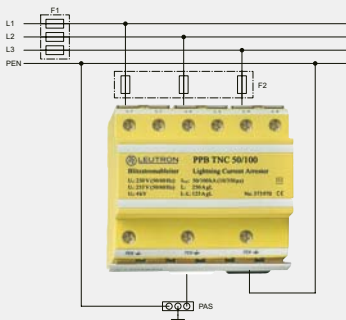
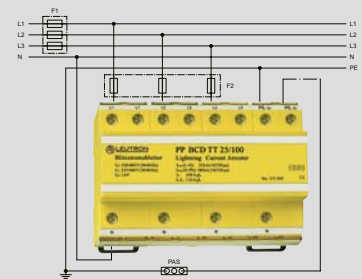
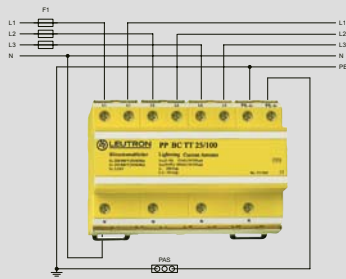
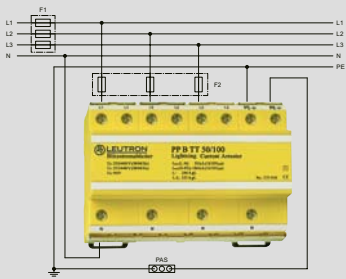
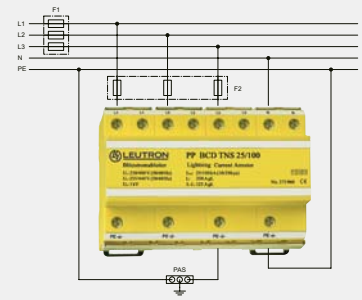
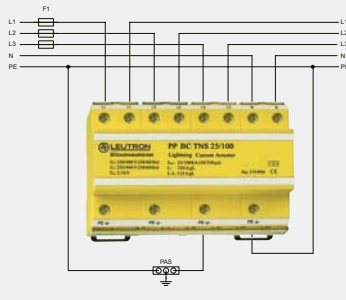
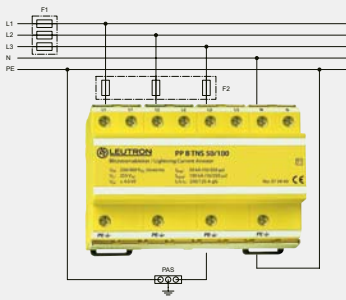

**The letters used have the following significance:**

The FIRST LETTER describes the earthing conditions of the supplying power source of the electrical installation:

- **T** direct earthing of one point of the powersource (generally the neutral point of the transformer)
- **I** Insulation of all active components from the earth or connection of one point of the powersource to earth via an impedance.

The SECOND LETTER describes the earthing conditions of the bodies of the equipment of the electrical installation:

- **T** Body of the equipment is earthed directly, regardless of any possible existing earthing of one point of the power supply,
- **N** Body of the electrical equipment is directly connected to the power system earthing (earthing of the power source of the electrical installation).

SUBSEQUENT LETTERS describe the arrangement of the neutral conductor and the protective conductor:

- **S** Neutral conductor and protective conductor are separate from each other,
- **C** Neutral conductor and protective conductor are combined (in one conductor).

\* according to the lightning protection zones concept



3 PHASE POWER SUPPLY SYSTEMS

1 PHASE POWER SUPPLY SYSTEMS

**Network type**

**Description**

**Adequate SPD circuit type**  
**Basic circuit diagram**

TN-S

3 phase power supply systems  
separated N and PE

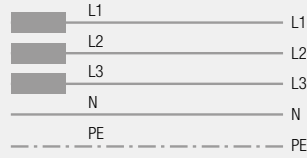

4 + 0-Circuit

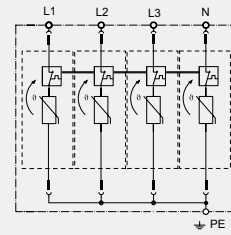

TT/ TN-S

3 phase power supply systems  
separated N and PE

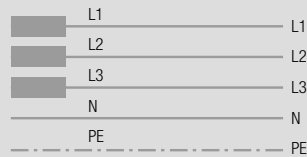

3 + 1-Circuit

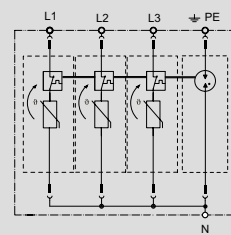

TN-C

3 phase power supply systems  
common PEN

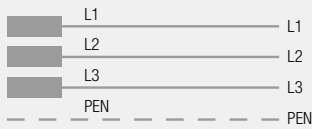

3 + 0-Circuit

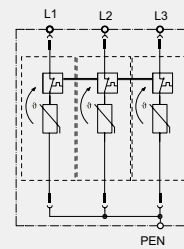

TT/ TN-S

1 phase power supply systems  
separated N and PE



1 + 1-Circuit

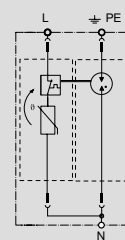

TN

1 phase power supply systems  
L/N to PE



1 + 0-Circuit

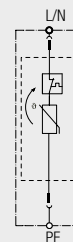





## Energetic coordination of surge arresters (SPDs)

Coordinated SPD protection is an integral part of the current lightning protection standard DIN EN 62305-4 (VDE 0185-305-4): 2011-10. DIN EN 62305-4 (VDE 0185-305-4) deals with the protection of structures with electrical and electronic systems against the effects of the electromagnetic lightning impulse (LEMP) by a LEMP protection system. The LEMP protection system is called LPMS.

The LPMS consists of the following protective measures:

- Grounding and equipotential bonding
- Spatial shielding
- Cable routing and shielding
- coordinated SPD protection

### Purpose of the coordination

The number of SPDs installed in a system to be protected depends on the requirements of the lightning protection zone concept, the strength of the equipment and the characteristics of the SPDs used.

The voltage hazard level of the selected SPD must correspond to the strength of the equipment to be protected and the requirements of the insulation coordination of the low voltage installation.

The energetic coordination must prevent SPDs from being overloaded within the system. For this, the individual load of the SPDs must be determined depending on their installation location and their characteristics.

As soon as two or more SPDs are connected in series, the coordination of the SPDs and the devices to be protected must be checked.

The energetic coordination is achieved if, for all momentum currents, the proportion of energy for each SPD is equal to or less than its energy strength.

The energy resistance can be determined from:

- An electrical test according to IEC 61643-11
- The technical data of the manufacturer of the SPD

### The basic principle

The basic principle of energetic coordination between SPDs is that each SPD derives only the amount of disruptive energy for which the SPD is designed.

The energetic coordination is achieved if, for all momentum currents, the proportion of energy for each SPD is equal to or less than its energy strength.

The following standards provide information:

DIN EN 62305-4 (VDE 0185-305-4) Lightning protection standard  
IEC 61312-3  
IEC 61643-12 for low voltage power supplies  
IEC 61643-22 for telecom and signal processing networks  
VDE 0100 Part 534 Application standard for low-voltage systems

### The practice

In a new construction project for example, the allocation of electrical engineering to different companies (for example, the creation of the main distribution (HV) to the company X and the production of subdistribution (UV) to the company Y.

Company X uses in the NSHV as SPD the make 1 and company Y for its UV the make 2.

In this case, the manufacturer of the SPDs must prove the coordination. If the exact class is known, it is easy for the manufacturer of the SPDs to prove the energetic coordination. In practice, at least for larger new construction projects, moreover, the HV are spatially separated from the UV accordingly and thus have a sufficient decoupling inductance over the given line length.

Today, modern spark gaps also work without decoupling elements. This is technically implemented in the so-called combi-arresters their application.

Voltage-limiting SPDs (e.g. with varistors) used as type 1 in main distributors (only behind the meter) and type 2 in the sub-distributors do not require any decoupling elements.

### Summary

Common practice in new building business and also otherwise, the use of different SPDs of several manufacturers z. B. in main and subdistributions as well as the terminal. Ensuring energetic coordination is relatively easy if the exact SPD class is known and can be easily demonstrated by the SPD manufacturer.

No standard or directive stipulates that overvoltage protection devices ÜSE (SPD = Surge Protective Device) of only one manufacturer may be used in one system.

According to DIN EN 62305-4 (VDE 0185-305-4), Section 7 Coordinated SPD protection, the selection and installation of an SPD set (Type 1 + Type 2 + Type 3) must comply with the requirements of IEC 61643-12 and IEC 60364-53 for the protection of power supply systems

IEC 61643-22 for the protection of telecommunication and data systems.

Leutron's SPDs, like other reputable manufacturers, meet the above requirements. This ensures that the devices comply with the recognized rule of technology.

Regardless of the manufacturer, all SPDs that meet the aforementioned standards have been tested and tested according to the same criteria.

The energetic coordination of the SPDs among each other depends not only on the device itself, but also on the installation (correct cable routing, compliance with cable lengths, impedance of the cable).

### Conclusion

Whether a spark arrester or varistor base, a Type 2 arrester can be used behind a Type 1 arrester, and a Type 3 arrester after a Type 2 arrester, regardless of the manufacturer.

The energetic coordination is ensured by compliance with the test standards and the corresponding application standards. Separate decoupling elements are not required for Leutron arresters in combination with third-party products. The energetic coordination is guaranteed in every case.



<b>AC power supply</b>	<b>Page</b>	<b>Arrester type 1 + 2 + 3 for 40-mm busbar</b>	<b>47</b>
<b>Lightning current arrester type 1 for AC power supplies / CT Series</b>	<b>12</b>	Multipole compact lightning current discharge arrester for the use in 3 phase TT and TNS systems (3+1-circuit). Application in pre-counter section on 40-mm busbar	
Multipole pluggable lightning current arrester for the use in TNS, TT and TNC systems, with rare-gas-filled spark gap. With remote signal contact. $U_c$ : 350 Volt ~		<b>Connection boxes with SPD type 1</b>	<b>49</b>
<b>Combined arrester type 1 + 2 for AC power supplies / CT series</b>	<b>14</b>	Connection boxes in pre-counter section for the use in 3 phase TT, TNS and TNC systems (according to DIN VDE 0100-443 und -534).	
Multipole, pluggable lightning current discharge arrester for the use in TNS, TT and TNC systems, with rare-gas-filled spark gap. With remote signal contact. $U_c$ : 350 Volt ~		<b>Connection boxes with SPD type 1 + 2</b>	<b>50</b>
<b>Combined arrester type 1 + 2 + 3 for AC power supplies / CT series</b>	<b>16</b>	Connection boxes in pre-counter section for the use in 3 phase TT, TNS and TNC systems (according to DIN VDE 0100-443 und -534).	
Multipole, pluggable lightning current discharge arrester for the use in TNS, TT and TNC systems, with rare-gas-filled spark gap. With remote signal contact. $U_c$ : 350 Volt ~		<b>Connection boxes with SPD type 1 + 2 + 3</b>	<b>51</b>
<b>Lightning current arrester type 1 for AC power supplies / PowerPro series</b>	<b>18</b>	Connection boxes in pre-counter section for the use in 3 phase TT, TNS and TNC systems (according to DIN VDE 0100-443 und -534).	
Multipole compact lightning current arresters for 1, 2 and 3 phase TNS, TT, TNC, TN and IT systems. With remote signal contact.		<b>SPD type 2 for AC power supplies / EL series</b>	<b>52</b>
<b>Combined arrester type 1 + 2 for AC power supplies / PowerPro series</b>	<b>22</b>	Fully pluggable surge protective arrester for the use in all power supply systems. Versions for various voltage levels.	
Multipole compact lightning current discharge arrester for the use in 1, 2 and 3 phase TNS, TT, TNC, TN and IT systems. With remote signal contact.		<b>SPD type 2 for AC power supplies / EnerPro</b>	<b>61</b>
<b>Combined arrester type 1 + 2 + 3 for AC power supplies / PowerPro series</b>	<b>26</b>	Multipole compact leakage current free SPD e. g. for the use in 3 phase TNS, TT, TNC systems and 2 phase TT1+1, TN and IT systems. Function control by LED.	
Multipole compact lightning current discharge arrester for the use in 1, 2 and 3 phase TNS, TT, TNC, TN and IT systems. With remote signal contact.		<b>SPD type 3 for AC power supplies</b>	<b>67</b>
<b>Lightning current arrester type 1 for AC power supplies / IsoPro series</b>	<b>34</b>	Terminal protection for DIN rail mounting in different power supply systems, flushmounting, compact and pluggable executions.	
Multipole compact lightning current arresters for 1, 2 and 3 phase systems. With remote signal contact. Series connection of MOV and GDT: parallel to spark gap.		Surge Protection for new LED Lighting Systems	<b>78</b>
<b>Combined arrester type 1 + 2 for AC power supplies / IsoPro series</b>	<b>37</b>	<b>DC power supply</b>	<b>79</b>
Multipole compact SPDs for the use in 1, 2 and 3 phase systems. With remote signal contact. Series connection of MOV and GDT: parallel to spark gap.		Surge protective device type 2 (+3) for different rated load current (from 6 up to 100 Ampere) and nominal voltage DC from 12 up to 220 Volt)	
<b>Combined pluggable arrester type 1 + 2 for AC power supplies / EnerProS series</b>	<b>45</b>	<b>Surge arresters for Photovoltaic Installations</b>	<b>92</b>
Multipole pluggable combinend arrester, e.g. for the use in 3 phase TNS, TT and TNC systems. Mechanical status indicator. Leakage current free variants available.		SPD are placed inside the connection box of the solar generator and on the DC side of the inverter.	
<b>Combined arrester type 1 + 2 for AC power supplies / SumPro</b>	<b>46</b>	<b>Accessories power supply</b>	<b>97</b>
Single pole NPE lightning current arrester class I+II, based on isolating spark gap technology.		Busbars, a. s. o.	



### Lightning current arrester type 1 for AC power supplies / CT Series

#### CT-T1

Multipole pluggable lightning current arrester for the use in TNS, TT and TNC systems, with rare-gas-filled spark gap. They provide extremely high discharge capabilities with at the same time very low protection levels and they also do not need any damageable internal or external electronic trigger.



example image

- Applicable at the boundaries LPZ OA - 1
- Test standard: IEC 61643-11 / EN 61643-11
- Vibration test standard: DIN EN 60068-2-6, IEC 60068-2-6
- Shock test standard: DIN EN 60068-2-27, IEC 60068-2-27
- Mounting on 35 mm DIN rail (EN 60715)
- Enclosure material: thermoplastic with the colors yellow and black
- Degree of protection according to IEC EN 60529: IP 20
- Inflammability class according to UL 94 V0
- EAC certification
- No leakage currents, thus, allowing installation upstream of power meters
- Optical status indication (red pin appears)
- Single modules can be replaced easily
- Remote changeover contact
- Max. operating voltage remote contact: 250 V AC/125 V DC
- Max. operating current remote contact: 1 A AC/200 mA DC
- Max. locking torque FM terminals: 0,25 Nm

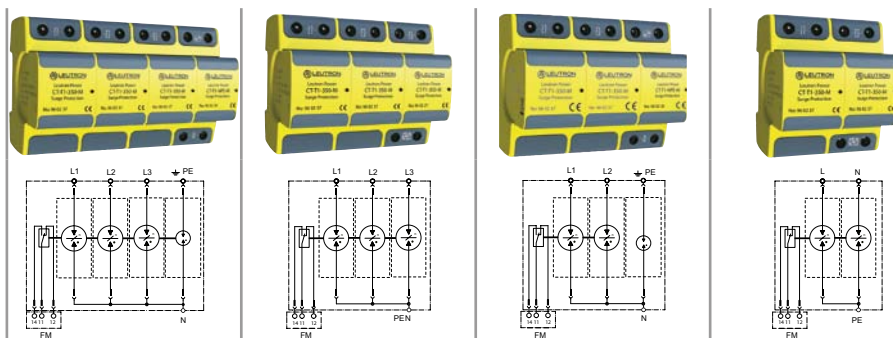

#### Technical Data

Product name	CT-T1/3+1-350-FM	CT-T1/3+0-350-FM	CT-T1/2+1-350-FM	CT-T1/2+0-350-FM
Article-No.	96 02 07	96 02 09	96 02 11	96 02 13
IEC category	Type 1 / class I	Type 1 / class I	Type 1 / class I	Type 1 / class I
Nominal voltage AC	UN 230/400 V~	230/400 V~	230/400 V~	230/400 V~
Max. continuous operating voltage AC (50/60Hz)	Uc 350 V~	350 V~	350 V~	350 V~
Lightning impulse current (10/350µs) total	Itotal 100 kA	75 kA	100 kA	50 kA
Lightning impulse current (10/350µs) L-N/N-PE/L-PEN	Iimp 25 / 100 / - kA	- / - / 25 kA	25 / 100 / - kA	- / 25 / 25 kA
Nominal discharge current (8/20) L-N/N-PE/L-PEN	In 25 / 100 / - kA	- / - / 25 kA	25 / 100 / - kA	- / 25 / 25 kA
Protection level	Up ≤ 2,5 kV	≤ 2,5 kV	≤ 2,5 kV	≤ 2,5 kV
Follow-on current ext. capability AC L-N (260V AC)	Iff 10 kAeff	10 kAeff	10 kAeff	10 kAeff
Short-circuit withstand capability at max. back-up fuse	Ik 50 kAeff	50 kAeff	50 kAeff	50 kAeff
Max. acceptable backup fuse (branch wiring)	250 A gG	250 A gG	250 A gG	250 A gG
Max. acceptable backup fuse (V-type through wiring)	125 A gG	125 A gG	125 A gG	125 A gG
Max. Operating temperature range	TU -40 - +80 °C	-40 - +80 °C	-40 - +80 °C	-40 - +80 °C
Min. conductor cross section at terminals	10mm² solid/flexible	10mm² solid/flexible	10mm² solid/flexible	10mm² solid/flexible
Max. Conductor cross section at terminals	50mm² stranded/35mm² flexible	50mm² stranded/35mm² flexible	50mm² stranded/35mm² flexible	50mm² stranded/35mm² flexible
Max. connection torque for terminals	4,0 Nm	4,0 Nm	4,0 Nm	4,0 Nm
Power supply system	3 phase TNS and TT systems	3 phase TNC systems	2 phase TT system	1 phase TN system
Composed of: number of modules	3x 96 02 37 + 1x 96 02 38	3x 96 02 37	2x 96 02 37 / 1x 96 02 38	2x 96 02 37
Installation width	8 TE	6 TE	6 TE	4 TE

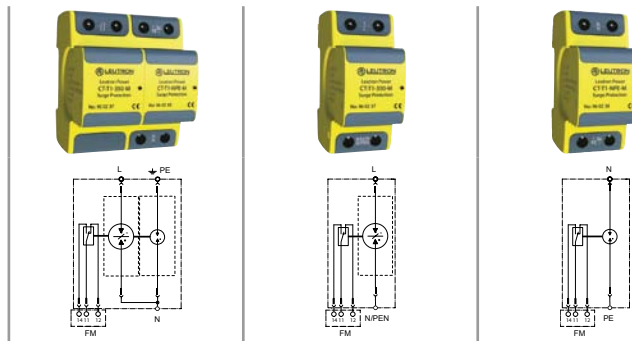

### Technical Data

Product name	CT-T1/1+1-350-FM	CT-T1/1+0-350-FM	CT-T1/0+1-FS-FM
Article-No.	96 02 15	96 02 17	96 02 33
IEC category	Type 1 / class I	Type 1 / class I	Type 1 / class I
Nominal voltage AC	UN 230/400 V~	230/400 V~	230 V~
Max. continuous operating voltage AC (50/60Hz)	Uc 350 V~	350 V~	260 V~
Lightning impulse current (10/350µs) total	I <sub>total</sub> 50 kA	25 kA	100 kA
Lightning impulse current (10/350µs) L-N/N-PE/L-PEN	I <sub>imp</sub> 25 / 50 / - kA	25 / - / 25 kA	- / 100 / - kA
Nominal discharge current (8/20) L-N/N-PE/L-PEN	I <sub>n</sub> 25 / 50 / - kA	25 / - / 25 kA	- / 100 / - kA
Protection level	U <sub>p</sub> ≤ 2,5 kV	≤ 2,5 kV	≤ 2,5 kV
Follow-on current ext. capability AC L-N (260V AC)	I <sub>fi</sub> 10 kA <sub>eff</sub>	10 kA <sub>eff</sub>	100 A <sub>eff</sub> (N-PE)
Short-circuit withstand capability at max. back-up fuse	I <sub>k</sub> 50 kA <sub>eff</sub>	50 kA <sub>eff</sub>	50 kA <sub>eff</sub>
Max. acceptable backup fuse (branch wiring)	250 A gG	250 A gG	250 A gG
Max. acceptable backup fuse (V-type through wiring)	125 A gG	125 A gG	125 A gG
Max. Operating temperature range	TU -40 - +80 °C	-40 - +80 °C	-40 - +80 °C
Min. conductor cross section at terminals	10mm <sup>2</sup> solid/flexible	10mm <sup>2</sup> solid/flexible	10mm <sup>2</sup> solid/flexible
Max. Conductor cross section at terminals	50mm <sup>2</sup> stranded/35mm <sup>2</sup> flexible	50mm <sup>2</sup> stranded/35mm <sup>2</sup> flexible	50mm <sup>2</sup> stranded/35mm <sup>2</sup> flexible
Max. connection torque for terminals	4,0 Nm	4,0 Nm	4,0 Nm
Power supply system	1 phase TT and TNS systems	between L and N	between N and PE
Composed of: number of moduls	1x 96 02 37 + 1x 96 02 38	1x 96 02 37	1x 96 02 38
Installation width	4 TE	2 TE	2 TE

### Dimensions

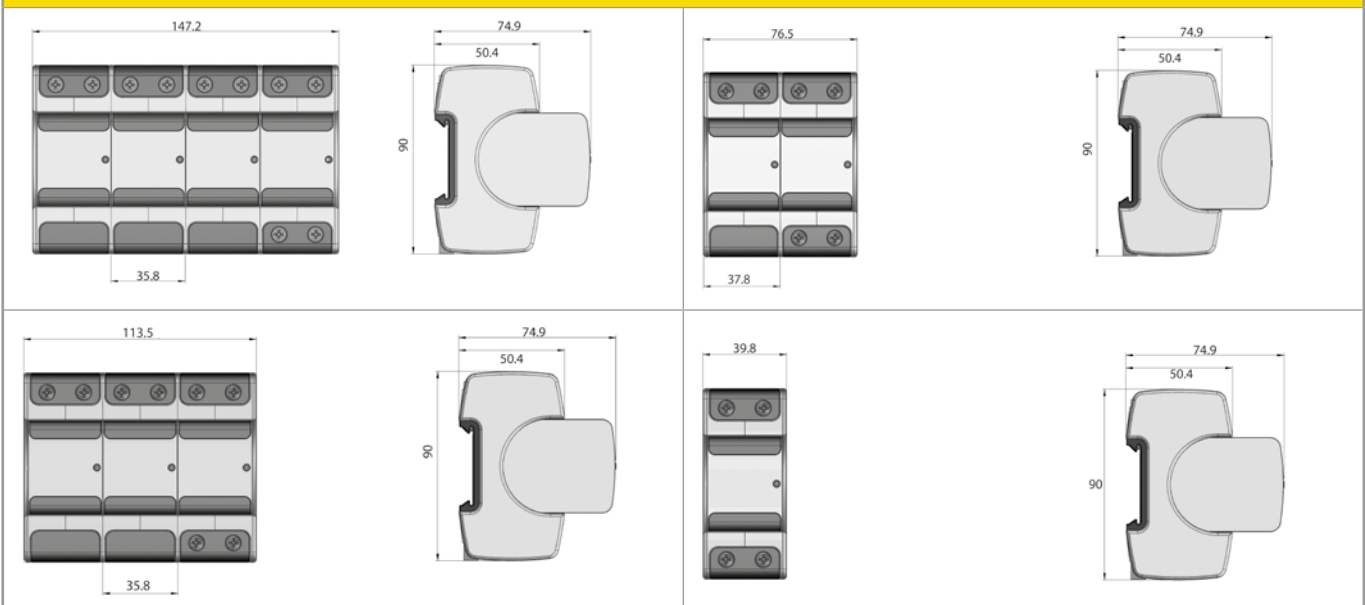

### Accessories

	CT-T1-350-M	CT-T1-NPE-M
Article-No.	96 02 37	96 02 38



Replacement protective plug for lightning current discharge arresters.



### Combined arrester type 1 + 2 for AC power supplies / CT series

#### CT-T1+2

Lightning current discharge arrester with rare-gas-filled spark gap and very low protection level < 1.5 kV for the use in three-phase TNS, TT and TN systems. They provide extremely high discharge capabilities with at the same time very low protection levels and they also do not need any damageable internal or external electronic trigger.



example image

- Applicable at the boundaries LPZ OA - 2
- Test standard: IEC 61643-11 / EN 61643-11
- Vibration test standard: DIN EN 60068-2-6, IEC 60068-2-6
- Shock test standard: DIN EN 60068-2-27, IEC 60068-2-27
- Mounting on 35 mm DIN rail (EN 60715)
- Enclosure material: thermoplastic with the colors yellow and black
- Degree of protection according to IEC EN 60529: IP 20
- Inflammability class according to UL 94 V0
- EAC certification
- Remote changeover contact
- No leakage currents, thus, allowing installation upstream of power meters
- Optical status indication (red pin appears)
- Single modules can be replaced easily
- Max. operating voltage remote contact: 250 V AC/125 V DC
- Max. operating current remote contact: 1 A AC/200 mA DC
- Max. locking torque FM terminals: 0,25 Nm

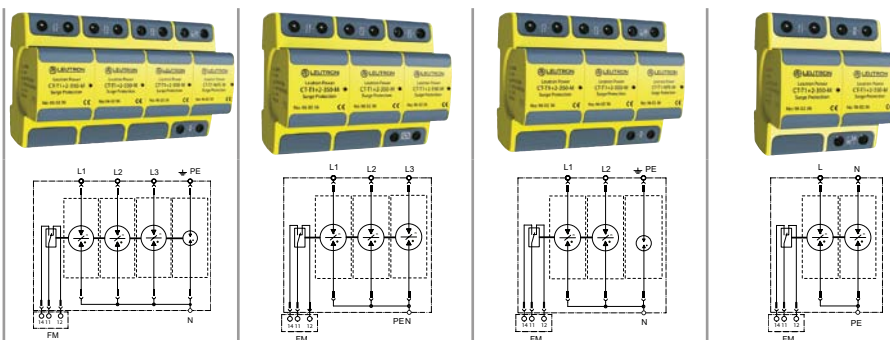

#### Technical Data

Product name	CT-T1+2/3+1-350-FM	CT-T1+2/3+0-350-FM	CT-T1+2/2+1-350-FM	CT-T1+2/2+0-350-FM
Article-No.	96 00 01	96 00 03	96 00 05	96 00 07
IEC category	Type 1 + 2 / class I+II	Type 1 + 2 / class I+II	Type 1 + 2 / class I+II	Type 1 + 2 / class I+II
Nominal voltage AC	UN 230/400 V~	230/400 V~	230/400 V~	230/400 V~
Max. continuous operating voltage AC (50/60Hz)	Uc 350 V~	350 V~	350 V~	350 V~
Lightning impulse current (10/350µs) total	Itotal 100 kA	75 kA	100 kA	50 kA
Lightning impulse current (10/350µs) L-N/N-PE/L-PEN	Iimp 25 / 100 / - kA	- / - / 25 kA	25 / 100 / - kA	- / 25 / 25 kA
Nominal discharge current (8/20) L-N/N-PE/L-PEN	In 25 / 100 / - kA	- / - / 25 kA	25 / 100 / - kA	- / 25 / 25 kA
Protection level	Up ≤ 1,5 kV	≤ 1,5 kV	≤ 1,5 kV	≤ 1,5 kV
Follow-on current ext. capability AC L-N (260V AC)	I <sub>fi</sub> 4,0 kAeff	4,0 kAeff	4,0 kAeff	4,0 kAeff
Short-circuit withstand capability at max. back-up fuse	I <sub>k</sub> 50 kAeff	50 kAeff	50 kAeff	50 kAeff
Max. acceptable backup fuse (branch wiring)	250 A gG	250 A gG	250 A gG	250 A gG
Max. acceptable backup fuse (V-type through wiring)	125 A gG	125 A gG	125 A gG	125 A gG
Max. Operating temperature range	TU -40 - +80 °C	-40 - +80 °C	-40 - +80 °C	-40 - +80 °C
Min. conductor cross section at terminals	10mm <sup>2</sup> solid/flexible	10mm <sup>2</sup> solid/flexible	10mm <sup>2</sup> solid/flexible	10mm <sup>2</sup> solid/flexible
Max. Conductor cross section at terminals	50mm <sup>2</sup> stranded/35mm <sup>2</sup> flexible	50mm <sup>2</sup> stranded/35mm <sup>2</sup> flexible	50mm <sup>2</sup> stranded/35mm <sup>2</sup> flexible	50mm <sup>2</sup> stranded/35mm <sup>2</sup> flexible
Max. connection torque for terminals	4,0 Nm	4,0 Nm	4,0 Nm	4,0 Nm
Power supply system	3 phase TNS and TT systems	3 phase TNC systems	2 phase TT system	1 phase TN system
Composed of: number of modules	3x 96 02 36 + 1x 96 02 38	3x 960236	2x 96 02 36 + 1x 96 02 38	2x 96 02 36
Installation width	8 TE	6 TE	6 TE	4 TE



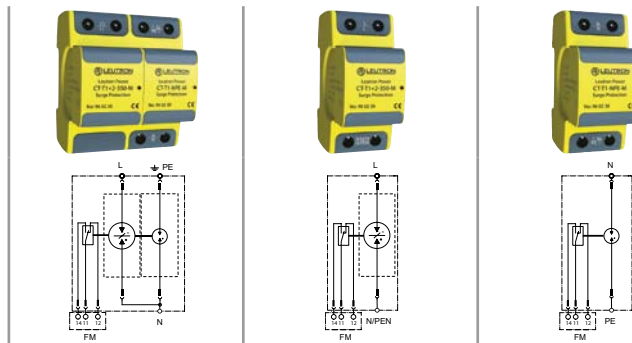

### Technical Data

Product name	CT-T1+2/1+1-350-FM	CT-T1+2/1+0-350-FM	CT-T1/0+1-FS-FM
Article-No.	96 00 09	96 00 11	96 02 33
IEC category	Type 1 + 2 / class I+II	Type 1 + 2 / class I+II	Type 1 / class I
Nominal voltage AC	UN 230/400 V~	230/400 V~	230 V~
Max. continuous operating voltage AC (50/60Hz)	Uc 350 V~	350 V~	260 V~
Lightning impulse current (10/350µs) total	I <sub>total</sub> 50 kA	25 kA	100 kA
Lightning impulse current (10/350µs) L-N/N-PE/L-PEN	I <sub>imp</sub> 25 / 50 / - kA	25 / - / 25 kA	- / 100 / - kA
Nominal discharge current (8/20) L-N/N-PE/L-PEN	I <sub>n</sub> 25 / 50 / - kA	25 / - / 25 kA	- / 100 / - kA
Protection level	Up ≤ 1,5 kV	≤ 1,5 kV	≤ 2,5 kV
Follow-on current ext. capability AC L-N (260V AC)	I <sub>fi</sub> 4,0 kAeff	4,0 kAeff	100 Aeff (N-PE)
Short-circuit withstand capability at max. back-up fuse	I <sub>k</sub> 50 kAeff	50 kAeff	50 kAeff
Max. acceptable backup fuse (branch wiring)	250 A gG	250 A gG	250 A gG
Max. acceptable backup fuse (V-type through wiring)	125 A gG	125 A gG	125 A gG
Max. Operating temperature range	TU -40 - +80 °C	-40 - +80 °C	-40 - +80 °C
Min. conductor cross section at terminals	10mm <sup>2</sup> solid/flexible	10mm <sup>2</sup> solid/flexible	10mm <sup>2</sup> solid/flexible
Max. Conductor cross section at terminals	50mm <sup>2</sup> stranded/35mm <sup>2</sup> flexible	50mm <sup>2</sup> stranded/35mm <sup>2</sup> flexible	50mm <sup>2</sup> stranded/35mm <sup>2</sup> flexible
Max. connection torque for terminals	4,0 Nm	4,0 Nm	4,0 Nm
Power supply system	1 phase TT and TNS systems	between L and N	between N and PE
Composed of: number of moduls	1x 96 02 36 + 1x 96 02 38	1x 96 02 36	1x 96 02 38
Installation width	4 TE	2 TE	2 TE

### Dimensions

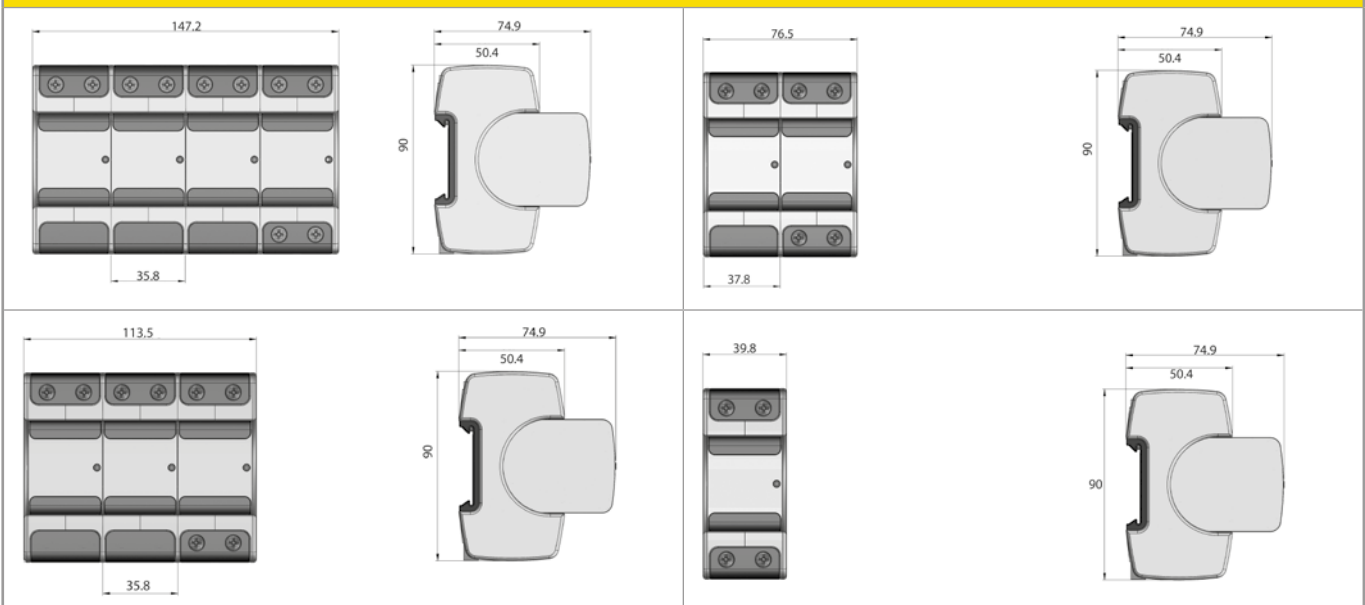

### Accessories

	CT-T1+2-350-M	CT-T1-NPE-M
Article-No.	96 02 36	96 02 38



Replacement protective plug for lightning current discharge arresters.



### Combined arrester type 1 + 2 + 3 for AC power supplies / CT series

#### CT-T1+2+3

Combined surge arrester with rare-gas-filled spark gap and very low protection level < 1.0 kV for the use in three-phase TT, TNC and TNS systems. They provide extremely high discharge capabilities with at the same time very low protection levels and they also do not need any damageable internal or external electronic trigger.



example image

- Applicable at the boundaries LPZ 0A - 2
- Test standard: IEC 61643-11 / EN 61643-11
- Vibration test standard: DIN EN 60068-2-6, IEC 60068-2-6
- Shock test standard: DIN EN 60068-2-27, IEC 60068-2-27
- Mounting on 35 mm DIN rail (EN 60715)
- Enclosure material: thermoplastic with the colors yellow and black
- Degree of protection according to IEC EN 60529: IP 20
- Inflammability class according to UL 94 V0
- EAC certification
- Remote changeover contact
- No leakage currents, thus, allowing installation upstream of power meters
- Optical status indication (red pin appears)
- Single modules can be replaced easily
- Max. operating voltage remote contact: 250 V AC/125 V DC
- Max. operating current remote contact: 1 A AC/200 mA DC
- Max. locking torque FM terminals: 0,25 Nm

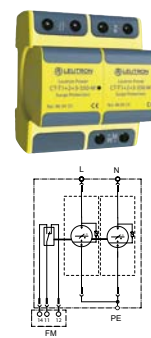
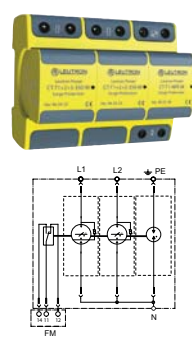
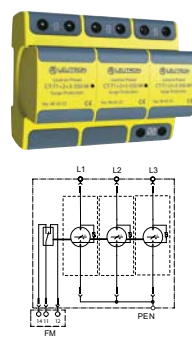
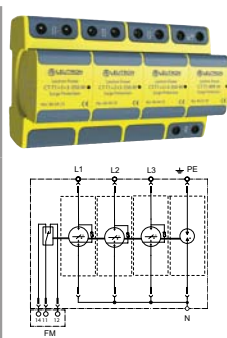

#### Technical Data

Product name	CT-T1+2+3/3+1-350-FM	CT-T1+2+3/3+0-350-FM	CT-T1+2+3/2+1-350-FM	CT-T1+2+3/2+0-350-FM
Article-No.	96 04 01	96 04 05	96 04 13	96 04 09
IEC category	Type 1 + 2 + 3 / class I+II+III	Type 1 + 2 + 3 / class I+II+III	Type 1 + 2 + 3 / class I+II+III	Type 1 + 2 + 3 / class I+II+III
Nominal voltage AC	UN 230/400 V~	230/400 V~	230/400 V~	230/400 V~
Max. continuous operating voltage AC (50/60Hz)	Uc 350 V~	350 V~	350 V~	350 V~
Lightning impulse current (10/350µs) total	Itotal 100 kA	75 kA	100 kA	50 kA
Lightning impulse current (10/350µs) L-N/N-PE/L-PEN	Iimp 25 / 100 / - kA	- / - / 25 kA	25 / 100 / - kA	25 / 25 / - kA
Nominal discharge current (8/20) L-N/N-PE/L-PEN	In 25 / 100 / - kA	- / - / 25 kA	25 / 100 / - kA	25 / 25 / - kA
Protection level	Up ≤ 1,0 kV	≤ 1,0 kV	≤ 1,0 kV	≤ 1,0 kV
Follow-on current ext. capability AC L-N (260V AC)	I <sub>fi</sub> 4,0 kAeff	4,0 kAeff	4,0 kAeff	4,0 kAeff
Short-circuit withstand capability at max. back-up fuse	I <sub>k</sub> 50 kAeff	50 kAeff	50 kAeff	50 kAeff
Max. acceptable backup fuse (branch wiring)	250 A gG	250 A gG	250 A gG	250 A gG
Max. acceptable backup fuse (V-type through wiring)	125 A gG	125 A gG	125 A gG	125 A gG
Max. Operating temperature range	TU -40 - +80 °C	-40 - +80 °C	-40 - +80 °C	-40 - +80 °C
Min. conductor cross section at terminals	10mm <sup>2</sup> solid/flexible	10mm <sup>2</sup> solid/flexible	10mm <sup>2</sup> solid/flexible	10mm <sup>2</sup> solid/flexible
Max. Conductor cross section at terminals	50mm <sup>2</sup> stranded/35mm <sup>2</sup> flexible	50mm <sup>2</sup> stranded/35mm <sup>2</sup> flexible	50mm <sup>2</sup> stranded/35mm <sup>2</sup> flexible	50mm <sup>2</sup> stranded/35mm <sup>2</sup> flexible
Max. connection torque for terminals	4,0 Nm	4,0 Nm	4,0 Nm	4,0 Nm
Power supply system	3 phase TNS and TT systems	3 phase TNC systems	2 phase TT system	1 phase TN system
Composed of: number of moduls	3x 96 04 25 + 1x 96 02 38	3x 96 04 25	2x 96 04 25 + 1x 96 02 38	2x 96 04 25
Installation width	8 TE	6 TE	6 TE	4 TE

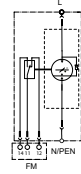
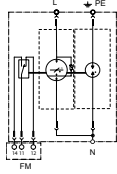

### Technical Data

Product name	CT-T1+2+3/1+1-350-FM	CT-T1+2+3/1+0-350-FM
Article-No.	96 04 17	96 04 21
IEC category	Type 1 + 2 + 3 / class I+II+III	Type 1 + 2 + 3 / class I+II+III
Nominal voltage AC	UN 230/400 V~	230/400 V~
Max. continuous operating voltage AC (50/60Hz)	Uc 350 V~	350 V~
Lightning impulse current (10/350µs) total	Itotal 50 kA	25 kA
Lightning impulse current (10/350µs) L-N/N-PE/L-PEN	Iimp 25 / 50 / - kA	25 / - / - kA
Nominal discharge current (8/20) L-N/N-PE/L-PEN	In 25 / 50 / - kA	25 / - / 25 kA
Protection level	Up ≤ 1,0 kV	≤ 1,0 kV
Follow-on current ext. capability AC L-N (260V AC)	Ifi 4,0 kAeff	4,0 kAeff
Short-circuit withstand capability at max. back-up fuse	Ik 50 kAeff	50 kAeff
Max. acceptable backup fuse (branch wiring)	250 A gG	250 A gG
Max. acceptable backup fuse (V-type through wiring)	125 A gG	125 A gG
Max. Operating temperature range	TU -40 - +80 °C	-40 - +80 °C
Min. conductor cross section at terminals	10mm <sup>2</sup> solid/flexible	10mm <sup>2</sup> solid/flexible
Max. Conductor cross section at terminals	50mm <sup>2</sup> stranded/35mm <sup>2</sup> flexible	50mm <sup>2</sup> stranded/35mm <sup>2</sup> flexible
Max. connection torque for terminals	4,0 Nm	4,0 Nm
Power supply system	1 phase TT and TNS systems	between L and N
Composed of: number of moduls	1x 96 04 25 + 1x 96 02 38	1x 96 04 25
Installation width	4 TE	2 TE

### Accessories

Accessories	CT-T1+2+3-350-M	CT-T1-NPE-M
Article-No.	96 04 25	96 02 38

Replacement protective plug for lightning current discharge arresters.





### Lightning current arrester Type 1 for AC power supplies / PowerPro

#### PowerPro B

Multipole lightning current arrester for the use in 1, 2 and 3 phase TNS, TT, TNC, TN and IT systems. The arresters can be installed at the transition OA to 1 according to the lightning protection zones concept. The SPDs of the series PowerPro B feature a high thermal resistance and an outstanding discharge capability for lightning impulse currents of 50 kA (10/350  $\mu$ s) per pole. Therefore, they can be applied according to DIN EN 62305 (VDE 0185-305).



example image

- Test standard: IEC 61643-11 / EN 61643-11
- Discharge capacity up to 100 kA (10/350  $\mu$ s)
- High insulation resistance
- High quenching of follow-on short-circuit currents
- Operates independently of atmospheric air pressure and ambient humidity
- All-in-one protection unit, ready for connection
- Degree of protection according to IEC EN 60529: IP 20
- Mounting on 35 mm DIN rail (EN 60715)
- Inflammability class according to UL 94 V0
- EAC certification
- Remote signalling contact (FM): break contact
- Switching capacity FM: 250 V/2 A
- Max. conductor cross section FM: 1,5 mm<sup>2</sup>

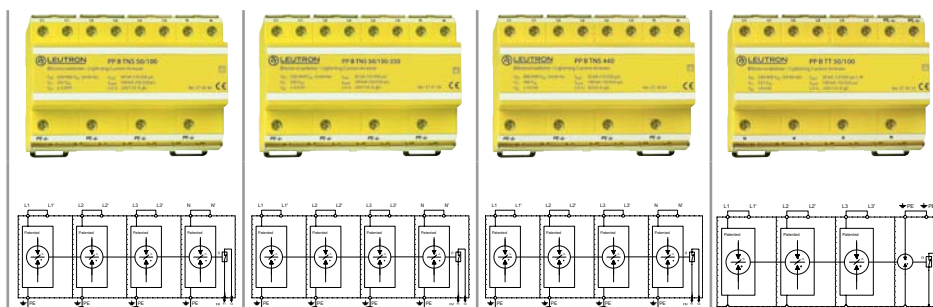

#### Technical Data

Product name	PP B TNS 50/100/FM	PP B TNS 50/100/FM-350	PP B TNS 440/FM	PP B TT 50/100/FM
Article-No.	37 39 42	37 41 25	37 39 44	37 39 12
IEC category	Type 1 / class I	Type 1 / class I	Type 1 / class I	Type 1 / class I
Nominal voltage AC	UN 230/400 V~	230/400 V~	400/690 V~	230/400 V~
Max. continuous operating voltage AC (50/60Hz)	Uc 255 V~	350 V~	440 V~	255 V~
Insulation resistance	Risol >10 G $\Omega$	>10 G $\Omega$	>10 G $\Omega$	>10 G $\Omega$
Protection level at 100% lightning imp. sparkover voltage (1.2/50 $\mu$ s)	Up $\leq$ 4,0 kV	$\leq$ 4,0 kV	$\leq$ 4,0 kV	$\leq$ 4,0 kV
Protection level	Up $\leq$ 4,0 kV	$\leq$ 4,0 kV	$\leq$ 4,0 kV	$\leq$ 4,0 kV
Response time	tA <50 ns	<50 ns	<50 ns	<50 ns
Lightning impulse current (10/350 $\mu$ s) total	Itotal 100 kA	100 kA	100 kA	100 kA
Lightning impulse current (10/350 $\mu$ s)	Iimp 50 / 50 / - kA	50 / 50 / - kA	25 / 25 / - kA	50 / 100 / - kA
Follow-on current ext. capability at Uc (50/60 Hz)	Iff 4,0 kA	4,0 kA	4,0 kA	4,0 kA
Short-circuit withstand capability at max. back-up fuse	Ik 50 kAeff	50 kAeff	50 kAeff	50 kAeff
Max. acceptable back-up fuse F2 (spur wiring)	250 A gG	250 A gG	63 A gG	250 A gG
Max. acceptable back-up fuse F1 (serial wiring)	125 A gG	125 A gG	63 A gG	125 A gG
Operating temperature range	TU -40 - +80 °C	-40 - +80 °C	-40 - +80 °C	-40 - +80 °C
Max. conductor cross section	50mm <sup>2</sup> stranded/35mm <sup>2</sup> flexible	50mm <sup>2</sup> stranded/35mm <sup>2</sup> flexible	50mm <sup>2</sup> stranded/35mm <sup>2</sup> flexible	50mm <sup>2</sup> stranded/35mm <sup>2</sup> flexible
Recommended conductor cross section	25 mm <sup>2</sup>	25 mm <sup>2</sup>	25 mm <sup>2</sup>	25 mm <sup>2</sup>
Max. connection torque for terminals	4,0 Nm	4,0 Nm	4,0 Nm	4,0 Nm
Installation width	8 TE	8 TE	8 TE	8 TE
Power supply system	3 phase TNS systems	3 phase TNS systems	3 phase TNS systems	3 phase TT systems

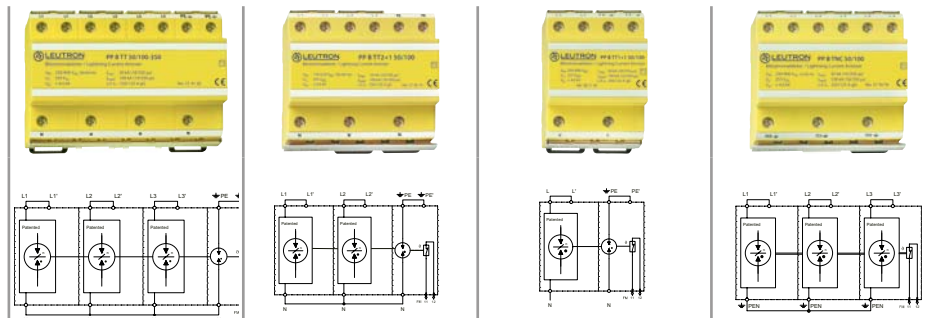

### Technical Data

Product name	PP B TT 50/100/FM-350	PP B TT2+1 50/100/FM	PP B TT1+1 50/100/FM	PP B TNC 50/100/FM
Article-No.	37 41 35	37 39 17	38 11 31	37 39 72
IEC category	Type 1 / class I	Type 1 / class I	Type 1 / class I	Type 1 / class I
Nominal voltage AC	UN 230/400 V~	100/200 bzw. 110/220 V~	230/400 V~	230/400 V~
Max. continuous operating voltage AC (50/60Hz)	Uc 350 V~	255 V~	255 V~	255 V~
Insulation resistance	Risol >10 GΩ	>10 GΩ	>10 GΩ	>10 GΩ
Protection level at 100% lightn. imp. sparkover voltage (1.2/50μs)	Up ≤ 4,0 kV	≤ 4,0 kV	≤ 4,0 kV	≤ 4,0 kV
Protection level	Up ≤ 4,0 kV	≤ 4,0 kV	≤ 4,0 kV	≤ 4,0 kV
Response time	tA <50 ns	<50 ns	<50 ns	<50 ns
Lightning impulse current (10/350 μs) total	I <sub>total</sub> 100 kA	100 kA	100 kA	100 kA
Lightning impulse current (10/350 μs)	I <sub>imp</sub> 50 / 100 / - kA	50 / 100 / - kA	50 / 100 / - kA	- / - / 50 kA
Follow-on current ext. capability at U <sub>c</sub> (50/60 Hz)	I <sub>fi</sub> 4,0 kA	4,0 kA	4,0 kA	4 kA
Short-circuit withstand capability at max. back-up fuse	I <sub>k</sub> 50 kA <sub>eff</sub>	50 kA <sub>eff</sub>	50 kA <sub>eff</sub>	50 kA <sub>eff</sub>
Max. acceptable back-up fuse F2 (spur wiring)	250 A gG	250 A gG	250 A gG	250 A gG
Max. acceptable back-up fuse F1 (serial wiring)	125 A gG	125 A gG	125 A gG	125 A gG
Operating temperature range	TU -40 - +80 °C	-40 - +80 °C	-40 - +80 °C	-40 - +80 °C
Max. conductor cross section	50mm <sup>2</sup> stranded/35mm <sup>2</sup> flexible	50mm <sup>2</sup> stranded/35mm <sup>2</sup> flexible	50mm <sup>2</sup> stranded/35mm <sup>2</sup> flexible	50mm <sup>2</sup> stranded/35mm <sup>2</sup> flexible
Recommended conductor cross section	25 mm <sup>2</sup>	25 mm <sup>2</sup>	25 mm <sup>2</sup>	25 mm <sup>2</sup>
Max. connection torque for terminals	4,0 Nm	4,0 Nm	4,0 Nm	4,0 Nm
Installation width	8 TE	6 TE	4 TE	6 TE
Power supply system	3 phase TT systems	2 phase TT systems	1 phase TT systems	3 phase TNC systems

### Dimensions

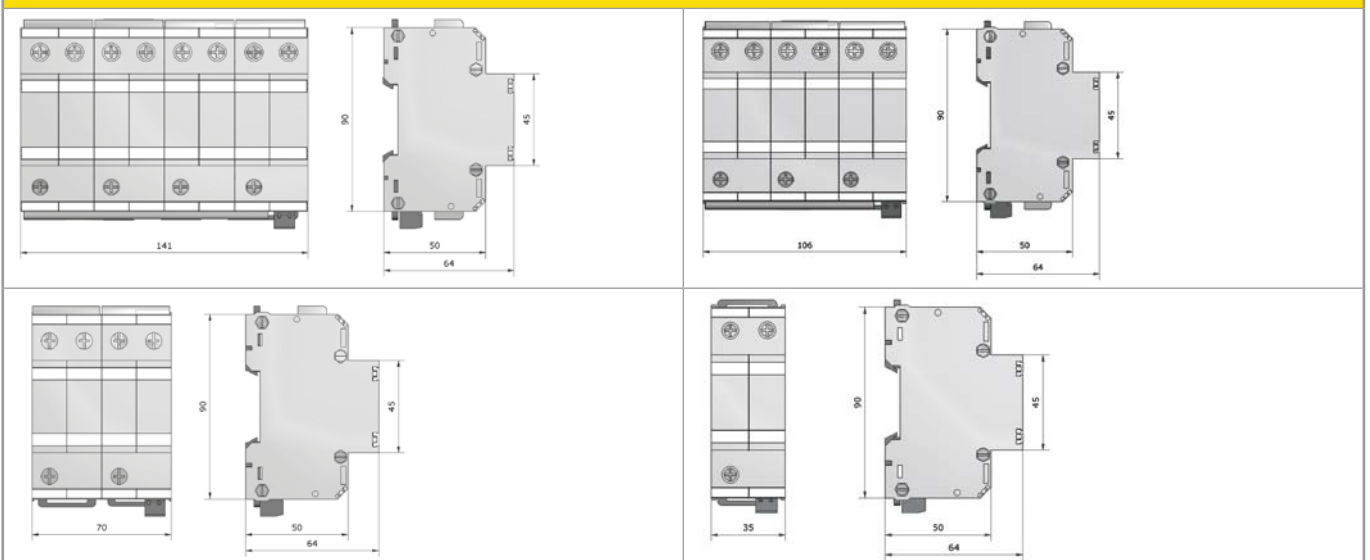



### Lightning current arrester Type 1 for AC power supplies / PowerPro

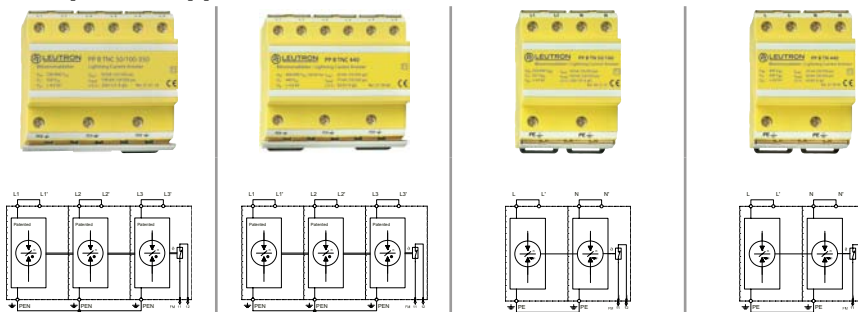

#### Technical Data

Product name	PP B TNC 50/100-350/FM	PP B TNC 440/FM	PP B TN 50/100/FM	PP B TN 440/FM
Article-No.	37 41 15	37 39 65	38 12 11	37 39 46
IEC category	Type 1 / class I	Type 1 / class I	Type 1 / class I	Type 1 / class I
Nominal voltage AC	UN 230/400 V~	400/690 V~	230/400 V~	400 V~
Max. continuous operating voltage AC (50/60 Hz)	Uc 350 V~	440 V~	255 V~	440 V~
Insulation resistance	Risol >10 GΩ	>10 GΩ	>10 GΩ	>10 GΩ
Protection level at 100% lightn. imp. sparkover voltage (1.2/50μs)	Up ≤ 4,0 kV	≤ 4,0 kV	≤ 4,0 kV	≤ 4,0 kV
Protection level	Up ≤ 4,0 kV	≤ 4,0 kV	≤ 4,0 kV	≤ 4,0 kV
Response time	tA <50 ns	<50 ns	<50 ns	< 50 ns
Lightning impulse current (10/350 μs) total	Itotal 100 kA	75 kA	100 kA	50 kA
Lightning impulse current (10/350 μs)	Iimp - / - / 50 kA	- / - / 25 kA	- / 50 / - kA	25 / 25 / - kA
Follow-on current ext. capability at Uc (50/60 Hz)	I <sub>fi</sub> 4,0 kA	4 kA	4 kA	4 kA
Short-circuit withstand capability at max. back-up fuse	I <sub>k</sub> 50 kA <sub>eff</sub>	50 kA <sub>eff</sub>	50 kA <sub>eff</sub>	50 kA <sub>eff</sub>
Max. acceptable back-up fuse F2 (spur wiring)	250 A gG	63 A gG	250 A gG	63 A gG
Max. acceptable back-up fuse F1 (serial wiring)	125 A gG	63 A gG	125 A gG	63 A gG
Operating temperature range	TU -40 - +80 °C	-40 - +80 °C	-40 - +80 °C	-40 - +80 °C
Max. conductor cross section	50mm <sup>2</sup> stranded/35mm <sup>2</sup> flexible	50mm <sup>2</sup> stranded/35mm <sup>2</sup> flexible	50mm <sup>2</sup> stranded/35mm <sup>2</sup> flexible	50mm <sup>2</sup> stranded/35mm <sup>2</sup> flexible
Recommended conductor cross section	25 mm <sup>2</sup>	25 mm <sup>2</sup>	25 mm <sup>2</sup>	25 mm <sup>2</sup>
Max. connection torque for terminals	4,0 Nm	4,0 Nm	4,0 Nm	4,0 Nm
Installation width	6 TE	6 TE	4 TE	4 TE
Power supply system	3 phase TNC systems	3 phase TNC systems	1 phase TN system	1 phase TN system



### Lightning current arrester Type 1 for AC power supplies / PowerPro

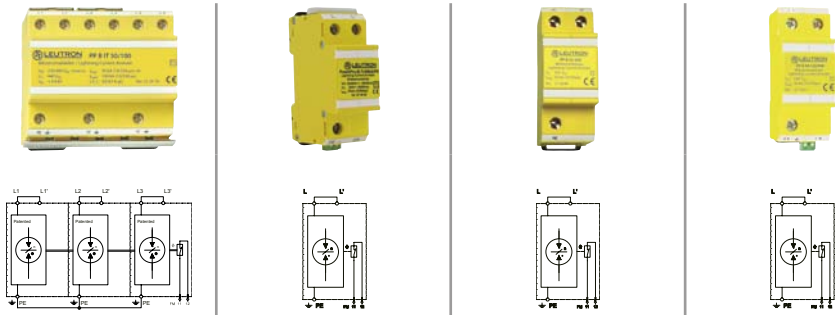

#### Technical Data

Product name	PP B IT 50/100/FM	PowerPro B-Tr/50kA/Pk	PP B 50-350/FM	PP B 50-520/FM
Article-No.	37 39 19	37 38 40	37 38 85	37 70 01
IEC category	Type 1 / class I	Type 1 / class I	Type 1 / class I	Type 1 / class I
Nominal voltage AC	UN 230/400 V~	230/400 V~	230/400 V~	230/400 V~
Max. continuous operating voltage AC (50/60Hz)	Uc 440 V~	255 V~	350 V~	520 V~
Insulation resistance	Risol >10 GΩ	> 10 GΩ	> 10 GΩ	> 10 GΩ
Protection level at 100% lightning imp. sparkover voltage (1.2/50μs)	Up ≤ 4,0 kV	≤ 4,0 kV	≤ 4,0 kV	≤ 4,0 kV
Protection level	Up ≤ 4,0 kV	≤ 4,0 kV	≤ 1 kV	≤ 2,5 kV
Response time	tA <50 ns	< 50 ns	< 50 ns	< 50 ns
Lightning impulse current (10/350 μs) total	Itotal 100 kA	50 kA	50 kA	50 kA
Lightning impulse current (10/350 μs)	Iimp 50 / - / - kA	50 / - / - kA	50 / - / - kA	50 / - / - kA
Follow-on current ext. capability at Uc (50/60 Hz)	I <sub>fi</sub> 4 kA	4 kA	3 kA	3 kA
Short-circuit withstand capability at max. back-up fuse	I <sub>k</sub> 50 kA <sub>eff</sub>	4,0 kA <sub>eff</sub>	50 kA <sub>eff</sub>	50 kA <sub>eff</sub>
Max. acceptable back-up fuse F2 (spur wiring)	63 A gG	250 A gG	250 A gG	250 A gG
Max. acceptable back-up fuse F1 (serial wiring)	63 A gG	125 A gG	125 A gG	125 A gG
Operating temperature range	TU -40 - +80 °C	-40 - +80 °C	-40 - +80 °C	-40 - +80 °C
Max. conductor cross section	50mm <sup>2</sup> stranded/35mm <sup>2</sup> flexible	50mm <sup>2</sup> stranded/35mm <sup>2</sup> flexible	50mm <sup>2</sup> stranded/35mm <sup>2</sup> flexible	50mm <sup>2</sup> stranded/35mm <sup>2</sup> flexible
Recommended conductor cross section	25 mm <sup>2</sup>	25 mm <sup>2</sup>	25 mm <sup>2</sup>	25 mm <sup>2</sup>
Max. connection torque for terminals	4,0 Nm	4,0 Nm	4,0 Nm	4,0 Nm
Installation width	6 TE	2 TE	2 TE	2 TE
Power supply system	3 phase IT systems	between L and PE	between L and PE	between L and PE

### PP B 25-760/FM

Lightning current arrester (class I) for wind energy applications for lightning protection equipotential bonding in 690 V IT systems.

- Test standard: IEC 61643-11 / EN 61643-11
- Degree of protection according to IEC EN 60529: IP 20
- Mounting on 35 mm DIN rail (EN 60715)
- Inflammability class according to UL 94 V0
- EAC certification
- Remote signalling contact (FM): break contact
- Switching capacity FM: 250 V/2 A
- Max. conductor cross section FM: 1,5 mm<sup>2</sup>

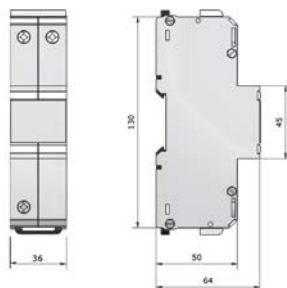
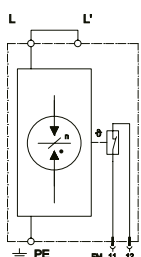

Technical Data		
<b>Product name</b>		<b>PP B 25-760/FM</b>
Article-No.		37 45 21
IEC category	Type 1 / class I	
Nominal voltage AC	UN 690 V~	
Max. continuous operating voltage AC (50/60Hz)	Uc 760 V~	
Insulation resistance	Risol < 10 GΩ	
Protection level	Up 4,0 kV	
Response time	tA 100 ns	
Lightning impulse current (10/350 μs)	Itotal 25 kA	
Max. acceptable back-up fuse F2 (spur wiring)	250 A gG	
Max. acceptable back-up fuse F1 (serial wiring)	125 A gG	
Max. conductor cross section	50mm <sup>2</sup> stranded/35mm <sup>2</sup> flexible	
Recommended conductor cross section	25 mm <sup>2</sup>	
Max. connection torque for terminals	4,0 Nm	
Installation width	2 TE	
Power supply system	between L and PE	



### Combined arrester type 1 + 2 for AC power supplies / PowerPro

#### PowerPro BC

Multipole combined arrester for the use in 1, 2 and 3 phase TNS, TT, TNC, TN and IT systems. The arresters can be installed at the transition OA to 2 according to the lightning protection zones concept. The SPDs of the series PowerPro BC feature a high thermal resistance and an outstanding discharge capability for lightning impulse currents of 50 kA (10/350  $\mu$ s) per pole. Therefore, they can be applied according to DIN EN 62305 (VDE 0185-305).



example image

- Test standard: IEC 61643-11 / EN 61643-11
- Discharge capacity up to 100 kA (10/350  $\mu$ s)
- All-in-one protection unit, ready for connection
- No leakage currents, thus, allowing installation upstream of power meters
- Degree of protection according to IEC EN 60529: IP 20
- Mounting on 35 mm DIN rail (EN 60715)
- Inflammability class according to UL 94 V0
- EAC certification
- Remote signalling contact (FM): break contact
- Switching capacity FM: 250 V/2 A
- Max. conductor cross section FM: 1,5 mm<sup>2</sup>

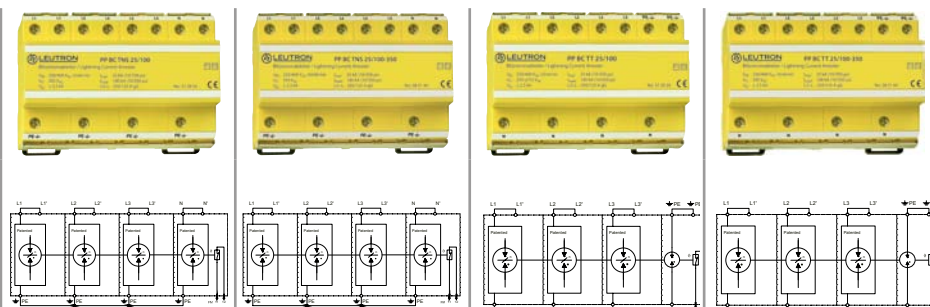

#### Technical Data

Product name	PP BC TNS 25/100/FM	PP BC TNS 25/100/FM-350	PP BC TT 25/100/FM	PP BC TT 25/100/FM-350
Article-No.	37 39 52	38 51 50	37 39 22	38 51 70
IEC category	Type 1 + 2 / class I+II			
Nominal voltage AC	UN 230/400 V~	230/400 V~	230/400 V~	230/400 V~
Max. continuous operating voltage AC (50/60 Hz)	Uc 255 V~	350 V~	255 (275) V~	350 V~
Insulation resistance	Risol >10 G $\Omega$	>10 G $\Omega$	>10 G $\Omega$	>10 G $\Omega$
Protection level at 100% lightning imp. sparkover voltage (1.2/50 $\mu$ s)	Up $\leq 2,5$ kV	$\leq 2,5$ kV	$\leq 2,5$ kV	$\leq 2,5$ kV
Protection level	Up $\leq 2,5$ kV	$\leq 2,5$ kV	$\leq 2,5$ kV	$\leq 2,5$ kV
Response time	tA <50 ns	<50 ns	<50 ns	<50 ns
Lightning impulse current (10/350 $\mu$ s) total	Itotal 100 kA	100 kA	100 kA	100 kA
Lightning impulse current (10/350 $\mu$ s)	Iimp 25 / - / - kA	25 / - / - kA	25 / 100 / - kA	25 / 100 / - kA
Follow-on current extinguishing capability at Uc (50/60 Hz) Ifi	4 kA	4 kA	4,0 kA	4,0 kA
Short-circuit withstand capability at max. back-up fuse	I <sub>k</sub> 50 kA <sub>eff</sub>	50 kA <sub>eff</sub>	50 kA <sub>eff</sub>	50 kA <sub>eff</sub>
Max. acceptable back-up fuse F2 (spur wiring)	250 A gG	250 A gG	250 A gG	250 A gG
Max. acceptable back-up fuse F1 (serial wiring)	125 A gG	125 A gG	125 A gG	125 A gG
Operating temperature range	TU -40 - +80 °C	-40 - +80 °C	-40 - +80 °C	-40 - +80 °C
Max. conductor cross section	50mm <sup>2</sup> stranded/35mm <sup>2</sup> flexible	50mm <sup>2</sup> stranded/35mm <sup>2</sup> flexible	50mm <sup>2</sup> stranded/35mm <sup>2</sup> flexible	50mm <sup>2</sup> stranded/35mm <sup>2</sup> flexible
Recommended conductor cross section	25 mm <sup>2</sup>	25 mm <sup>2</sup>	25 mm <sup>2</sup>	10 / 25 mm <sup>2</sup>
Max. connection torque for terminals	4,0 Nm	4,0 Nm	4,0 Nm	4,0 Nm
Installation width	8 TE	8 TE	8 TE	8 TE
Power supply system	3 phase TNS systems	3 phase TNS systems	3 phase TT systems	3 phase TT systems



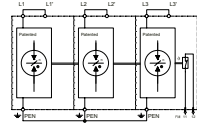
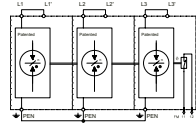
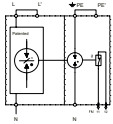
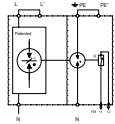

### Technical Data

Product name	PP BC TT1+1 25/100/FM	PP BC TT1+1 25/100/FM-350	PP BC TNC 25/75/FM	PP BC TNC 25/75/FM-350
Article-No.	38 11 33	38 52 10	37 39 82	38 51 30
IEC category	Type 1 + 2 / class I+II	Type 1 + 2 / class I+II	Type 1 + 2 / class I+II	Type 1 + 2 / class I+II
Nominal voltage AC	UN 230/400 V~	230/400 V~	230/400 V~	230/400 V~
Max. continuous operating voltage AC (50/60Hz)	Uc 255 V~	350 V~	255 V~	350 V~
Insulation resistance	Risol >10 GΩ	> 10 GΩ	>10 GΩ	> 10 GΩ
Protection level at 100% lightning imp. sparkover voltage (1.2/50μs)	Up ≤ 2,5 kV	≤ 2,5 kV	≤ 2,5 kV	≤ 2,5 kV
Protection level	Up ≤ 2,5 kV	≤ 2,5 kV	≤ 2,5 kV	≤ 2,5 kV
Response time	tA <50 ns	< 50 ns	<50 ns	< 50 ns
Lightning impulse current (10/350 μs) total	Itotal 100 kA	100 kA	75 kA	75 kA
Lightning impulse current (10/350 μs)	Iimp 25 / 100 / - kA	25 / 100 / - kA	25 / - / 75 kA	25 / - / 75 kA
Follow-on current extinguishing capability at Uc (50/60 Hz) I <sub>fi</sub>	4,0 kA	4,0 kA	4 kA	4 kA
Short-circuit withstand capability at max. back-up fuse	I <sub>k</sub> 50 kA <sub>eff</sub>	50 kA <sub>eff</sub>	50 kA <sub>eff</sub>	50 kA <sub>eff</sub>
Max. acceptable back-up fuse F2 (spur wiring)	250 A gG	250 A gG	250 A gG	250 A gG
Max. acceptable back-up fuse F1 (serial wiring)	125 A gG	125 A gG	125 A gG	125 A gG
Operating temperature range	TU -40 - +80 °C	-40 - +80 °C	-40 - +80 °C	-40 - +80 °C
Max. conductor cross section	50mm <sup>2</sup> stranded/35mm <sup>2</sup> flexible	50mm <sup>2</sup> stranded/35mm <sup>2</sup> flexible	50mm <sup>2</sup> stranded/35mm <sup>2</sup> flexible	50mm <sup>2</sup> stranded/35mm <sup>2</sup> flexible
Recommended conductor cross section	25 mm <sup>2</sup>	25 mm <sup>2</sup>	25 mm <sup>2</sup>	25 mm <sup>2</sup>
Max. connection torque for terminals	4,0 Nm	4,0 Nm	4,0 Nm	4,0 Nm
Installation width	4 TE	4 TE	6 TE	6 TE
Power supply system	1 phase TT systems	1 phase TT systems	3 phase TNC systems	3 phase TNC systems

### Dimensions

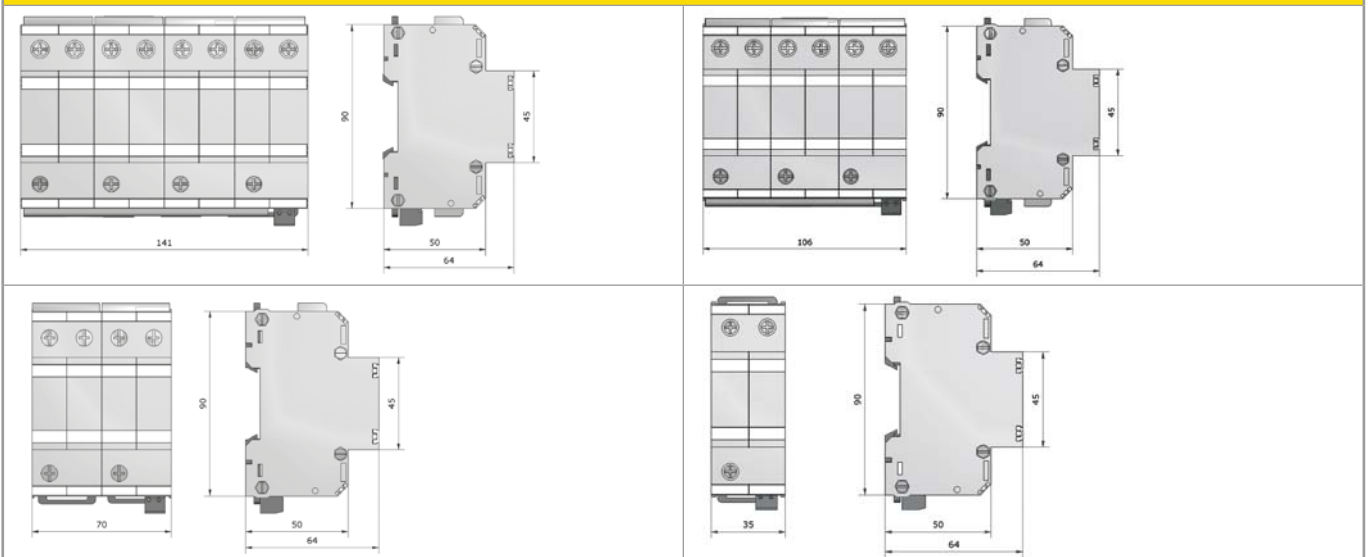



### Combined arrester type 1 + 2 for AC power supplies / PowerPro

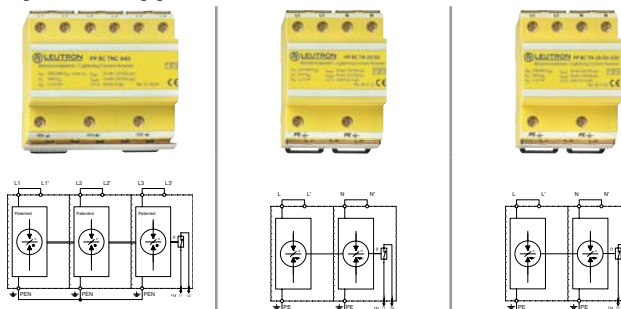

#### Technical Data

Product name	PP BC TNC 440/FM	PP BC TN 25/50/FM	PP BC TN 25/50/FM-350
Article-No.	37 39 83	38 12 13	38 51 90
IEC category	Type 1 + 2 / class I+II	Type 1 + 2 / class I+II	Type 1 + 2 / class I+II
Nominal voltage AC	UN 230/400 V~	230/400 V~	230/400 V~
Max. continuous operating voltage AC (50/60 Hz)	Uc 440 V~	255 V~	350 V~
Insulation resistance	Risol >10 GΩ	>10 GΩ	> 10 GΩ
Protection level at 100% lightning imp. sparkover voltage (1.2/50μs)	Up ≤ 2.0 kV	≤ 2,5 kV	≤ 2,5 kV
Protection level	Up ≤ 2.0 kV	≤ 2,5 kV	≤ 2,5 kV
Response time	tA <50 ns	< 50 ns	< 50 ns
Lightning impulse current (10/350 μs) total	Itotal 75 kA	50 kA	50 kA
Lightning impulse current (10/350 μs)	Iimp 25 / - / 75 kA	25 / 25 / - kA	25 / 25 / - kA
Follow-on current extinguishing capability at Uc (50/60 Hz) I <sub>fi</sub>	0,75 kA	4,0 kA	4,0 kA
Short-circuit withstand capability at max. back-up fuse	I <sub>k</sub> 50 kA <sub>eff</sub>	50 kA <sub>eff</sub>	50 kA <sub>eff</sub>
Max. acceptable back-up fuse F2 (spur wiring)	63 A gG	250 A gG	250 A gG
Max. acceptable back-up fuse F1 (serial wiring)	63 A gG	125 A gG	125 A gG
Operating temperature range	TU -40 - +80 °C	-40 - +80 °C	-40 - +80 °C
Max. conductor cross section	50mm <sup>2</sup> stranded/35mm <sup>2</sup> flexible	50mm <sup>2</sup> stranded/35mm <sup>2</sup> flexible	50mm <sup>2</sup> stranded/35mm <sup>2</sup> flexible
Recommended conductor cross section	25 mm <sup>2</sup>	25 mm <sup>2</sup>	25 mm <sup>2</sup>
Max. connection torque for terminals	4,0 Nm	4,0 Nm	4,0 Nm
Installation width	6 TE	4 TE	4 TE
Power supply system	3 phase TNC systems	1 phase TN system	1 phase TN system

#### Accessories

Article-No.	DAK 2x 16 17 01 10
-------------	-----------------------



Pin-shaped terminal to enable feed-through wiring (serial wiring) for all surge protection modules with only one clamp per phase.



## Combined arrester type 1 + 2 for AC power supplies / PowerPro

### PowerPro BC

For lightning protection equipotential bonding in 400 V TN-C systems e. g.  
Wind generator protection



- Test standard: IEC 61643-11 / EN 61643-11
- New developed ceramic isolating spark gap
- Low protection level
- Inflammability class according to UL 94 V0
- leakage current free
- Remote signalling contact (FM): break contact
- Mounting on 35 mm DIN rail (EN 60715)
- EAC certification

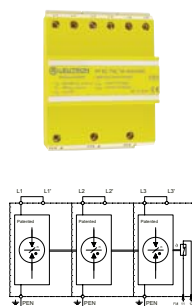
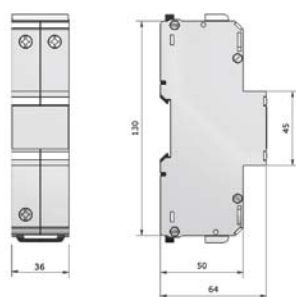

#### Technical Data

Product name	PP BC 50-440/FM	PP BC TNC 50-400/690/FM
Article-No.	37 45 01	37 45 05
IEC category	Type 1 + 2 / class I+II	Type 1 + 2 / class I+II
Nominal voltage AC	UN 400/690 V~	400/690 V~
Max. zul. Bemessungsspannung AC	Uc 440 V	440 V
Insulation resistance	Risol > 10 GΩ	> 10 GΩ
Protection level at 100% lightn. imp. sparkover voltage (1.2/50μs)	Up 2.5 kV	≤ 2,5 kV
Protection level	Up ≤ 2,5 kV	≤ 2,5 kV
Response time	tA 100 ns	100 ns
Lightning impulse current (10/350 μs)	Itotal 50 kA	150 kA
Lightning impulse current (10/350 μs)	Iimp - / 50 / - kA	- / - / 150 kA
Follow-on current extinguishing capability at Uc (50/60 Hz) Ifi	10 kA	10 kA
Short-circuit withstand capability at max. back-up fuse	Ik 50 kAeff	50 kAeff
Max. acceptable back-up fuse F2 (spur wiring)	250 A gG	250 A gG
Max. acceptable back-up fuse F1 (serial wiring)	125 A gG	125 A gG
Operating temperature range	TU -40 - +80 °C	-40 - +80 °C
Max. conductor cross section	50mm <sup>2</sup> stranded/35mm <sup>2</sup> flexible	50mm <sup>2</sup> stranded/35mm <sup>2</sup> flexible
Recommended conductor cross section	25 mm <sup>2</sup>	25 mm <sup>2</sup>
Max. connection torque for terminals	4,0 Nm	4,0 Nm
Installation width	2 TE	6 TE
Power supply system	between L and PE	3 phase TNC systems



### Combined arrester type 1 + 2 + 3 for AC power supplies / PowerPro

#### PowerPro BCD

Multipole compact combined arrester for the use in 1, 2 and 3 phase TNS, TT, TN, TNC and IT systems. The installation place of the PowerPro BCD is the main distribution board upstream or downstream of the power meter. According to the lightning protection zones concept in IEC DIN EN 62305 part 1-4 (VDE 0185-305-1-4), it can universally be installed at the transition OA to 2.



example image

- Test standard: IEC 61643-11 / EN 61643-11
- No leakage currents, thus, allowing installation upstream of power meters
- Rare-gas-filled spark gap, hermetically sealed
- Discharge capacity up to 100 kA (10/350 μs)
- All-in-one protection unit, ready for connection
- Operates independently of atmospheric air pressure and ambient humidity
- Inflammability class according to UL 94 V0
- EAC certification
- Remote signalling contact (FM): break contact
- Switching capacity FM: 250 V/2 A
- Max. conductor cross section FM: 1,5 mm<sup>2</sup>

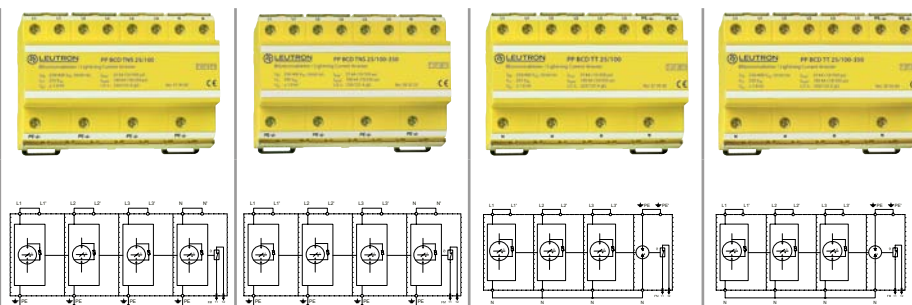

#### Technical Data

Product name	PP BCD TNS 25/100/FM	PP BCD TNS 25/100/FM-350	PP BCD TT 25/100/FM	PP BCD TT 25/100/FM-350
Article-No.	37 39 62	38 50 30	37 39 32	38 50 50
IEC category	Type 1 + 2 + 3 / class I+II+III	Type 1 + 2 + 3 / class I+II+III	Type 1 + 2 + 3 / class I+II+III	Type 1 + 2 + 3 / class I+II+III
Nominal voltage AC	UN 230/400 V~	230/400 V~	230/400 V~	230/400 V~
Max. continuous operating voltage AC (50/60Hz)	Uc 255 V~	350 V~	255 V~	350 V~
Insulation resistance	Risol >10 GΩ	>10 GΩ	>10 GΩ	>10 GΩ
Protection level at 100% lightning imp. sparkover voltage (1.2/50μs)	Up ≤ 1,0 kV	≤ 1,0 kV	≤ 1,0 kV	≤ 1,0 kV
Protection level	Up ≤ 1,0 kV	≤ 1,0 kV	≤ 1,0 kV	≤ 1,0 kV
Response time	tA <50 ns	<50 ns	<50 ns	<50 ns
Lightning impulse current (10/350 μs) total	Itotal 100 kA	100 kA	100 kA	100 kA
Lightning impulse current (10/350 μs)	Iimp 25 / 25 / - kA	25 / 25 / - kA	25 / 100 / - kA	25 / 100 / - kA
Follow-on current ext. capability at Uc (50/60 Hz)	Iff 4,0 kA	4,0 kA	4,0 kA	4,0 kA
Short-circuit withstand capability at max. back-up fuse	Ik 50 kAeff	50 kAeff	50 kAeff	50 kAeff
Max. acceptable back-up fuse F2 (spur wiring)	250 A gG	250 A gG	250 A gG	250 A gG
Max. acceptable back-up fuse F1 (serial wiring)	125 A gG	125 A gG	125 A gG	125 A gG
Operating temperature range	TU -40 - +80 °C	-40 - +80 °C	-40 - +80 °C	-40 - +80 °C
Max. conductor cross section	50mm <sup>2</sup> stranded/35mm <sup>2</sup> flexible	50mm <sup>2</sup> stranded/35mm <sup>2</sup> flexible	50mm <sup>2</sup> stranded/35mm <sup>2</sup> flexible	50mm <sup>2</sup> stranded/35mm <sup>2</sup> flexible
Recommended conductor cross section	25 mm <sup>2</sup>	25 mm <sup>2</sup>	25 mm <sup>2</sup>	25 mm <sup>2</sup>
Max. connection torque for terminals	4,0 Nm	4,0 Nm	4,0 Nm	4,0 Nm
Installation width	8 TE	8 TE	8 TE	8 TE
Power supply system	3 phase TNS systems	3 phase TNS systems	3 phase TT systems	3 phase TT systems

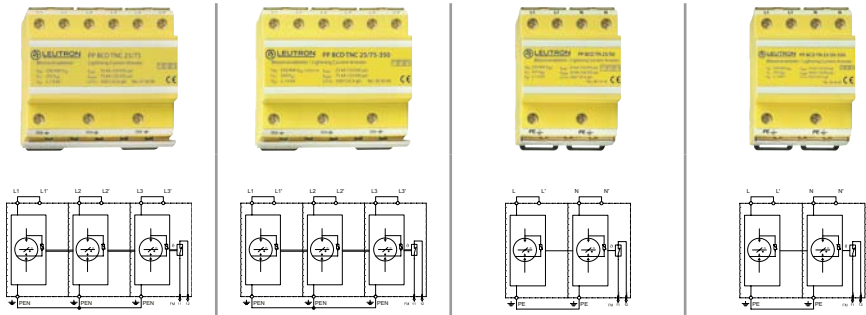

### Technical Data

Product name	PP BCD TNC 25/75/FM	PP BCD TNC 25/75/FM-350	PP BCD TN 25/50/FM	PP BCD TN 25/50/FM-350
Article-No.	37 39 92	38 50 10	38 12 15	38 50 70
IEC category	Type 1 + 2 + 3 / class I+II+III	Type 1 + 2 + 3 / class I+II+III	Type 1 + 2 + 3 / class I+II+III	Type 1 + 2 + 3 / class I+II+III
Nominal voltage AC	UN 230/400 V~	230/400 V~	230/400 V~	230/400 V~
Max. continuous operating voltage AC (50/60Hz)	Uc 255 V~	350 V~	255 V~	350 V~
Insulation resistance	Risol > 10 GΩ	>10 GΩ	>10 GΩ	>10 GΩ
Protection level at 100% lightning imp. sparkover voltage (1.2/50μs)	Up ≤ 1,0 kV	≤ 1,0 kV	≤ 1,0 kV	≤ 1,0 kV
Protection level	Up ≤ 1,0 kV	≤ 1,0 kV	≤ 1,0 kV	≤ 1,0 kV
Response time	tA < 50 ns	<50 ns	<50 ns	<50 ns
Lightning impulse current (10/350 μs) total	Itotal 75 kA	75 kA	50 kA	50 kA
Lightning impulse current (10/350 μs)	Iimp - / - / 25 kA	- / - / 25 kA	25 / 25 / - kA	25 / 25 / - kA
Follow-on current extinguishing capability at Uc (50/60 Hz) I <sub>fi</sub>	4,0 kA	4,0 kA	4,0 kA	4,0 kA
Short-circuit withstand capability at max. back-up fuse	I <sub>k</sub> 50 kA <sub>eff</sub>	50 kA <sub>eff</sub>	50 kA <sub>eff</sub>	50 kA <sub>eff</sub>
Max. acceptable back-up fuse F2 (spur wiring)	250 A gG	250 A gG	250 A gG	250 A gG
Max. acceptable back-up fuse F1 (serial wiring)	125 A gG	125 A gG	125 A gG	125 A gG
Operating temperature range	TU -40 - +80 °C	-40 - +80 °C	-40 - +80 °C	-40 - +80 °C
Max. conductor cross section	50mm <sup>2</sup> stranded/35mm <sup>2</sup> flexible	50mm <sup>2</sup> stranded/35mm <sup>2</sup> flexible	50mm <sup>2</sup> stranded/35mm <sup>2</sup> flexible	50mm <sup>2</sup> stranded/35mm <sup>2</sup> flexible
Recommended conductor cross section	25 mm <sup>2</sup>	25 mm <sup>2</sup>	25 mm <sup>2</sup>	25 mm <sup>2</sup>
Max. connection torque for terminals	4,0 Nm	4,0 Nm	4,0 Nm	4,0 Nm
Installation width	6 TE	6 TE	4 TE	4 TE
Power supply system	3 phase TNC systems	3 phase TNC systems	1 phase TN system	1 phase TN system

### Dimensions

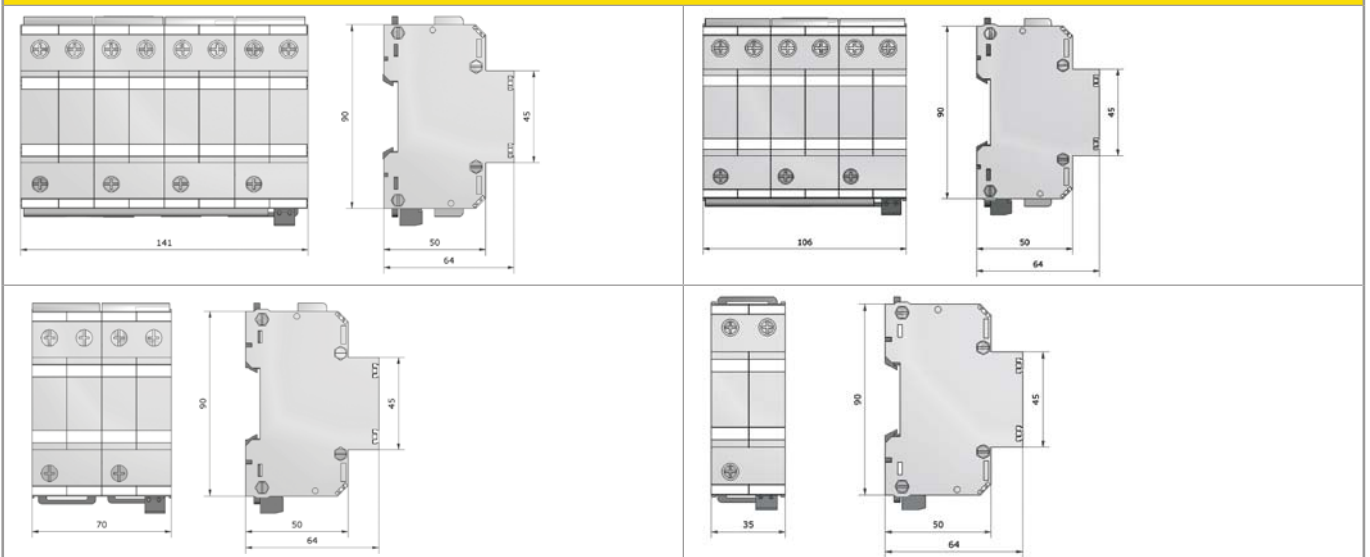



### Combined arrester type 1 + 2 + 3 for AC power supplies / PowerPro

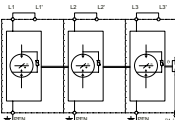
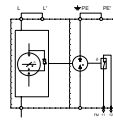
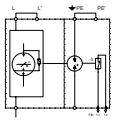
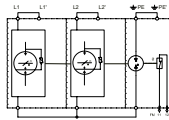





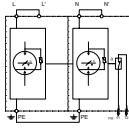

#### Technical Data

Product name	PP BCD TT2+1 25/100/FM	PP BCD TT1+1 25/100/FM	PP BCD TT1+1 25/100/FM-350	PP BCD IT-NO 25/75/FM
Article-No.	37 39 36	38 11 35	38 50 90	37 39 85
IEC category	Type 1 + 2 + 3 / class I+II+III			
Nominal voltage AC	UN 230/400 V~	230/400 V~	230/400 V~	230 V~
Max. continuous operating voltage AC (50/60Hz)	Uc 255 V~	255 V~	350 V~	440 V~
Insulation resistance	Risol >10 GΩ	> 10 GΩ	> 10 GΩ	>10 GΩ
Protection level at 100% lightning imp. sparkover voltage (1.2/50μs)	Up ≤ 1,0 kV	≤ 1,0 kV	≤ 1,0 kV	≤ 1,0 kV
Protection level	Up ≤ 1,0 kV	≤ 1,0 kV	≤ 1,0 kV	≤ 1,0 kV
Response time	tA <50 ns	< 50 ns	< 50 ns	<50 ns
Lightning impulse current (10/350 μs) total	Itotal 100 kA	100 kA	100 kA	75 kA
Lightning impulse current (10/350 μs)	Iimp 25 / 100 / - kA	25 / 100 / - kA	25 / 100 / - kA	- / - / 25 kA
Follow-on current ext. capability at Uc (50/60 Hz)	Ifi 4,0 kA	4,0 kA	4,0 kA	4,0 kA
Short-circuit withstand capability at max. back-up fuse	Ik 50 kAeff	50 kAeff	50 kAeff	25 kAeff
Max. acceptable back-up fuse F2 (spur wiring)	250 A gG	250 A gG	250 A gG	250 A gG
Max. acceptable back-up fuse F1 (serial wiring)	125 A gG	125 A gG	125 A gG	125 A gG
Operating temperature range	TU -40 - +80 °C	-40 - +80 °C	-40 - +80 °C	-40 - +80 °C
Max. conductor cross section	50mm <sup>2</sup> stranded/35mm <sup>2</sup> flexible	50mm <sup>2</sup> stranded/35mm <sup>2</sup> flexible	50mm <sup>2</sup> stranded/35mm <sup>2</sup> flexible	50mm <sup>2</sup> stranded/35mm <sup>2</sup> flexible
Recommended conductor cross section	25 mm <sup>2</sup>	25 mm <sup>2</sup>	25 mm <sup>2</sup>	25 mm <sup>2</sup>
Max. connection torque for terminals	4,0 Nm	4,0 Nm	4,0 Nm	4,0 Nm
Installation width	6 TE	4 TE	4 TE	6 TE
Power supply system	2 phase TT system	1 phase TT systems	1 phase TT systems	3 phase IT systems

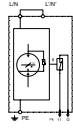

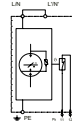
### Combined arrester type 1 + 2 + 3 for AC power supplies / PowerPro

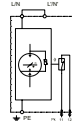
	 	 	 	 
<b>Technical Data</b>				
<b>Product name</b>	<b>PP BCD IT 2P 25/50-440/FM</b>	<b>PP BCD-Tr/25kA/Pk</b>	<b>PP BCD 25-350/FM</b>	<b>PP BCD-Tr/25kA/FM-350</b>
Article-No.	37 39 55	37 38 60	37 38 89	37 38 62
IEC category	Type 1 + 2 + 3 / class I+II+III	Type 1 + 2 + 3 / class I+II+III	Type 1 + 2 + 3 / class I+II+III	Type 1 + 2 + 3 / class I+II+III
Nominal voltage AC	UN 230/400 V~	230/400 V~	230/400 V~	230/400 - 240/415 V~
Max. continuous operating voltage AC (50/60Hz)	Uc 440 V~	255 V~	255 V~	350 V~
Insulation resistance	Risol >10 GΩ	>10 GΩ	>10 GΩ	>10 GΩ
Protection level at 100% lightning imp. sparkover voltage (1.2/50μs)	Up ≤ 1,0 kV	≤ 1.0 kV	≤ 1.0 kV	≤ 1.0 kV
Protection level	Up ≤ 1,0 kV	≤ 1.0 kV	≤ 1.0 kV	≤ 1.0 kV
Response time	tA <50 ns	50 ns	50 ns	50 ns
Lightning impulse current (10/350 μs)	Iimp 50 kA	25 kA	25 kA	25 kA
Max. impulse discharge current (8/20 μs)	Imax -	80 kA	80 kA	80 kA
Follow-on current extinguishing capability at Uc (50/60 Hz) I <sub>fi</sub>	4,0 kA	17,5 kA	17,5 kA	17,5 kA
Short-circuit withstand capability at max. back-up fuse	I <sub>sk</sub> 25 kA <sub>eff</sub>	50 kA <sub>eff</sub>	50 kA <sub>eff</sub>	50 kA <sub>eff</sub>
Max. acceptable back-up fuse F2 (spur wiring)	250 A gG	250 A gG	250 A gG	250 A gG
Max. acceptable back-up fuse F1 (serial wiring)	125 A gG	125 A gG	125 A gG	125 A gG
Operating temperature range	TU -40 - +80 °C	-40 - +80 °C	-40 - +80 °C	-40 - +80 °C
Max. conductor cross section	50mm <sup>2</sup> stranded/35mm <sup>2</sup> flexible	50mm <sup>2</sup> stranded/35mm <sup>2</sup> flexible	50mm <sup>2</sup> stranded/35mm <sup>2</sup> flexible	50mm <sup>2</sup> stranded/35mm <sup>2</sup> flexible
Recommended conductor cross section	25 mm <sup>2</sup>	25 mm <sup>2</sup>	25 mm <sup>2</sup>	25 mm <sup>2</sup>
Max. connection torque for terminals	4,0 Nm	4,0 Nm	4,0 Nm	4,0 Nm
Installation width	4 TE	2 TE	2 TE	2 TE
Power supply system	1 phase IT systems	between L and PE	between L and PE	between L and PE

#### Accessories

	DAK 2x 16
Article-No.	17 01 10



Pin-shaped terminal to enable feed-through wiring (serial wiring) for all surge protection modules with only one clamp per phase.



### Combined arrester type 1 + 2 + 3 for AC power supplies / PowerPro

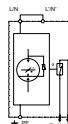
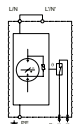

#### Technical Data

Product name	PP BCD 27kA/FM	PP BCD 27kA/FM-350
Article-No.	37 38 65	37 38 68
IEC category	Type 1 + 2 + 3 / class I+II+III	Type 1 + 2 + 3 / class I+II+III
Nominal voltage AC	UN 230 / 400 V~	230/400 V~
Max. continuous operating voltage AC (50/60 Hz)	Uc 255 V~	350 V~
Insulation resistance	Risol > 10 GΩ	> 10 GΩ
Protection level at 100% lightn. imp. sparkover voltage (1.2/50μs)	Up ≤ 1.0 kV	≤ 1.0 kV
Protection level	Up ≤ 1.0 kV	≤ 1.0 kV
Response time	tA < 50 ns	< 50 ns
Lightning impulse current (10/350 μs)	Iimp 27 kA	27 kA
Max. impulse discharge current (8/20 μs)	I <sub>max</sub> 80 kA	80 kA
Follow-on current extinguishing capability at U <sub>c</sub> (50/60 Hz) I <sub>fi</sub>	4.0 kA	4.0 kA
Short-circuit withstand capability at max. back-up fuse I <sub>k</sub>	25 kA <sub>eff</sub>	25 kA <sub>eff</sub>
Max. acceptable back-up fuse F2 (spur wiring)	250 A gG	250 A gG
Max. acceptable back-up fuse F1 (serial wiring)	125 A gG	125 A gG
Operating temperature range	TU -40 - +80 °C	-40 - +80 °C
Max. conductor cross section	50mm <sup>2</sup> stranded/35mm <sup>2</sup> flexible	50mm <sup>2</sup> stranded/35mm <sup>2</sup> flexible
Recommended conductor cross section	25 mm <sup>2</sup>	25 mm <sup>2</sup>
Max. connection torque for terminals	4,0 Nm	4,0 Nm
Installation width	2 TE	2 TE
Power supply system	between L and PE	between L and PE





## Combined arrester type 1 + 2 + 3 for AC power supplies / PowerPro

### PowerPro BCD-Tr-VA

Leakage-current free version to protect the foundation grounding electrode against AC-caused corrosion. Used as equipotential bonding lightning surge protection in different kind of power net systems.

- Test standard: IEC 61643-11 / EN 61643-11
- No blow-out vents, thus, not requiring any safety clearance to other installations
- Rare-gas-filled spark gap, hermetically sealed
- Surge arrester based on varistors (MOV) and GDT (Gas discharge tube)
- Mounting on 35 mm DIN rail (EN 60715)
- Remote signalling contact (FM): break contact
- Inflammability class according to UL 94 V0
- EAC certification
- Switching capacity FM: 250 V/2 A
- Max. conductor cross section FM: 1,5 mm<sup>2</sup>

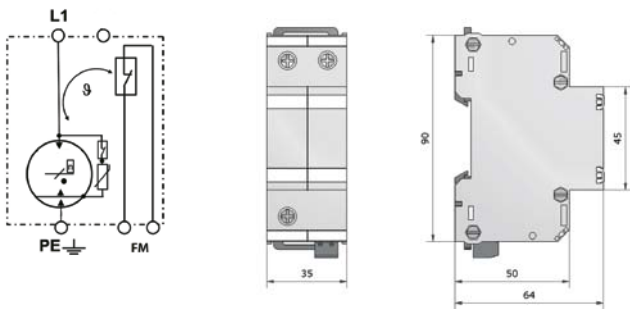

Technical Data	
<b>Product name</b>	<b>PP BCD-Tr/25kA-VA/FM</b>
Article-No.	37 38 61
IEC category	Type 1 + 2 + 3 / class I+II+III
Nominal voltage AC	UN 230/400 V~
Max. continuous operating voltage AC (50/60 Hz)	Uc 255 V~
Insulation resistance	Risol > 10 GΩ
Protection level at 100% lightning imp. sparkover voltage (1.2/50μs)	Up ≤ 1.0 kV
Protection level	Up ≤ 1,0 kV
Urest at 3kA (8/20) and 6kV (1,2/50)	Urest ≤ 800 V
Response time bei 1kV/μs	tA 50 ns
Lightning impulse current (10/350 μs)	limp 25 kA
Max. impulse discharge current (8/20 μs)	Imax 80 kA
Follow-on current ext. capability at Uc (50/60 Hz)	Ifi 17,5 kA
Short-circuit withstand capability at max. back-up fuse	Ik 50 kAeff
Max. acceptable back-up fuse F2 (spur wiring)	250 A gG
Max. acceptable back-up fuse F1 (serial wiring)	125 A gG
Max. conductor cross section	50mm <sup>2</sup> stranded/35mm <sup>2</sup> flexible
Recommended conductor cross section	25 mm <sup>2</sup>
Max. connection torque for terminals	4,0 Nm
Installation width	2 TE
Power supply system	between L and PE



### Combined arrester type 1 + 2 + 3 for AC power supplies / PowerPro

#### PowerPro BCD LED

Combined modular and compact multi-pole arrester for 1-, 2- and 3-phase TT, TNC and TN systems. The installation place of the PowerPro BCD is the main distribution board upstream of the power meter. According to the lightning protection zones concept in IEC DIN EN 62305 part 1-4 (VDE 0185-305-1-4), it can universally be installed at the transition OA to 2.



example image

- Test standard: IEC 61643-11 / EN 61643-11
- Monitoring of conductor and arrester via LED
- Not leakage current free
- Discharge capacity up to 100 kA (10/350  $\mu$ s)
- All-in-one protection unit, ready for connection
- Rare-gas-filled spark gap, hermetically sealed
- Serial wiring with multi-functional terminals
- Operates independently of atmospheric air pressure and ambient humidity
- Inflammability class according to UL 94 V0
- EAC certification
- Remote signalling contact (FM): break contact
- Switching capacity FM: 250 V/2 A
- Max. conductor cross section FM: 1,5 mm<sup>2</sup>

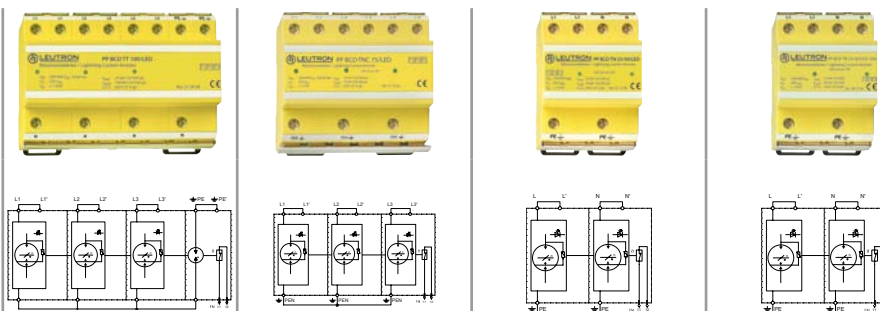

#### Technical Data

Product name	PP BCD TT 100/LED/FM	PP BCD TNC 75/LED/FM	PP BCD TN 25/50/LED/FM	PP BCD TN 25/50/LED/FM-350
Article-No.	37 39 59	37 39 57	37 12 02	38 51 10
IEC category	Type 1 + 2 + 3 / class I+II+III	Type 1 + 2 + 3 / class I+II+III	Type 1 + 2 + 3 / class I+II+III	Type 1 + 2 + 3 / class I+II+III
Nominal voltage AC	UN 230/400 V~	230/400 V~	230/400 V~	230/400 V~
Max. continuous operating voltage AC (50/60 Hz)	Uc 255 V~	255 V~	255 V~	350 V~
Insulation resistance	Risol >10 G $\Omega$	> 10 G $\Omega$	> 10 G $\Omega$	>10 G $\Omega$
Protection level at 100% lightning imp. sparkover voltage (1.2/50 $\mu$ s)	Up $\leq$ 1,0 kV	$\leq$ 1.0 kV	$\leq$ 1,0 kV	$\leq$ 1,0 kV
Protection level	Up $\leq$ 1,0 kV	$\leq$ 1.0 kV	$\leq$ 1,0 kV	$\leq$ 1,0 kV
Response time	tA < 50 ns	< 50 ns	< 50 ns	< 50 ns
Lightning impulse current (10/350 $\mu$ s) total	Itotal 100 kA	75 kA	50 kA	50 kA
Lightning impulse current (10/350 $\mu$ s)	Iimp 25 / 100 / - kA	- / - / 25 kA	- / 25 / - kA	25 / - / - kA
Follow-on current ext. capability at Uc (50/60 Hz)	Iff 4,0 kA	4,0 kA	4,0 kA	4,0 kA
Short-circuit withstand capability at max. back-up fuse	Ik 50 kAeff	50 kAeff	50 kAeff	50 kAeff
Max. acceptable back-up fuse F2 (spur wiring)	125 A gG	250 A gG	250 A gG	250 A gG
Max. acceptable back-up fuse F1 (serial wiring)	250 A gG	125 A gG	125 A gG	125 A gG
Operating temperature range	TU -40 - +80 °C	-40 - +80 °C	-40 - +80 °C	-40 - +80 °C
Max. conductor cross section	50mm <sup>2</sup> stranded/35mm <sup>2</sup> flexible	50mm <sup>2</sup> stranded/35mm <sup>2</sup> flexible	50mm <sup>2</sup> stranded/35mm <sup>2</sup> flexible	50mm <sup>2</sup> stranded/35mm <sup>2</sup> flexible
Recommended conductor cross section	25 mm <sup>2</sup>	25 mm <sup>2</sup>	25 mm <sup>2</sup>	25 mm <sup>2</sup>
Max. connection torque for terminals	4,0 Nm	4,0 Nm	4,0 Nm	4,0 Nm
Installation width	8 TE	6 TE	4 TE	4 TE
Power supply system	3 phase TT systems	3 phase TNC systems	1 phase TN system	1 phase TN system

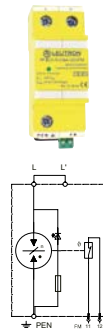
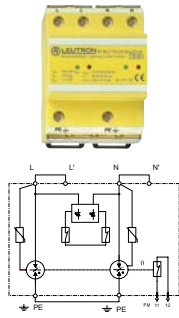

### Technical Data

Product name	PP BCD TN 25/50-LED-M/FM	PP BCD-Tr/25kA-LED/FM
Article-No.	38 12 09	37 38 49
IEC category	Type 1 + 2 + 3 / class I+II+III	Type 1 + 2 + 3 / class I+II+III
Nominal voltage AC	UN 230 / 400 V~	230 / 400 V~
Max. continuous operating voltage AC (50/60Hz)	Uc 350 V~	255 V~
Insulation resistance	Risol >10 GΩ	>10 GΩ
Protection level at 100% lightning imp. sparkover voltage (1.2/50μs)	Up ≤ 1,0 kV	≤ 1,0 kV
Protection level	Up ≤ 1,0 kV	≤ 1,0 kV
Residual voltage at 5kA (8/20μs)	Ures 600 V	-
Response time bei 1kV/μs	tA 50 ns	50 ns
Lightning impulse current (10/350 μs)	Iimp 25 kA	25 kA
Max. impulse discharge current (8/20μs)	Imax -	80 kA
Nominal discharge current (8/20μs)	In 40 kA	-
Follow-on current ext. capability at Uc (50/60 Hz)	Ifi 17,5 kA	17,5 kA
Short-circuit withstand capability at max. back-up fuse	I <sub>k</sub> 25 kA <sub>eff</sub>	50 kA <sub>eff</sub>
Max. acceptable back-up fuse F2 (spur wiring)	250 A gG	250 A gG
Max. acceptable back-up fuse F1 (serial wiring)	125 A gG	125 A gG
Max. conductor cross section	50mm <sup>2</sup> stranded/35mm <sup>2</sup> flexible	50mm <sup>2</sup> stranded/35mm <sup>2</sup> flexible
Recommended conductor cross section	25 mm <sup>2</sup>	25 mm <sup>2</sup>
Max. connection torque for terminals	4,0 Nm	4,0 Nm
Operating temperature range	TU -40 - +80 °C	-40 - +80 °C
Installation width	4 TE	2 TE
Power supply system	1 phase TN system	between L and N

### Dimensions

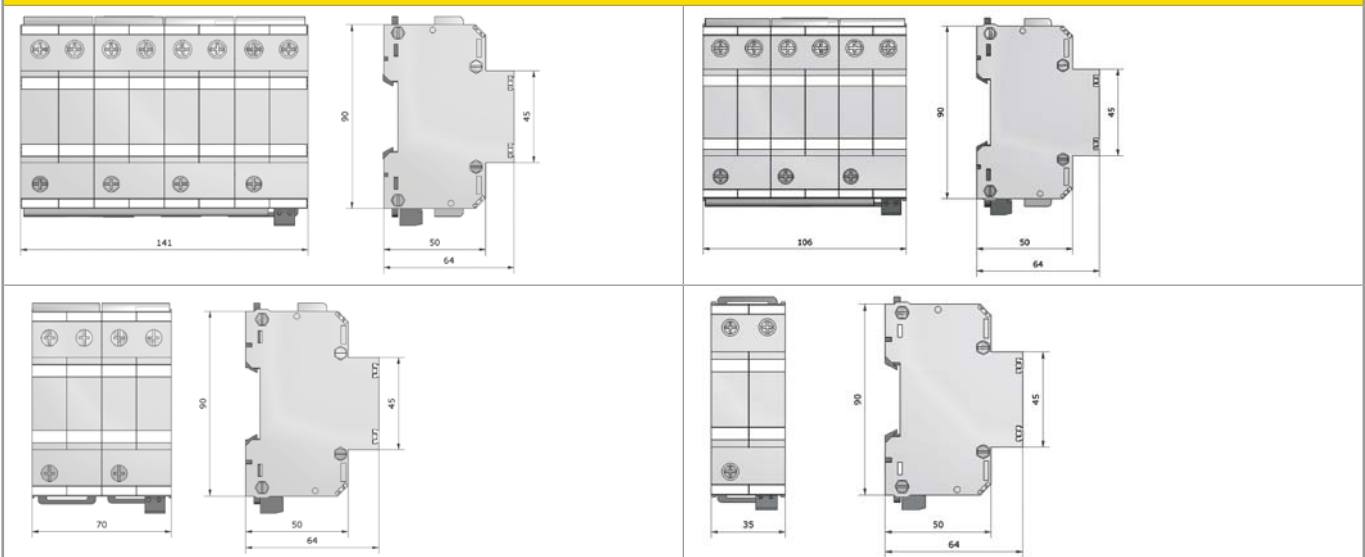



### Lightning current arrester type 1 for AC power supplies / IsoPro

#### IsoPro B

Multipole lightning current arrester type 1 for the use in 1, 2 and 3 phase TNS, TT, TNC, TN and IT systems, for protection of low-voltage consumers' installations in business and residential areas against surges caused by lightning or switching actions in the network. The arresters can be installed at the transition 0A to 1 according to the lightning protection zones concept.



example image

- Test standard: IEC 61643-11 / EN 61643-11
- Rare-gas-filled spark gap, hermetically sealed
- No leakage currents, thus, allowing installation upstream of power meters
- Operates independently of atmospheric air pressure and ambient humidity
- High insulation resistance
- Discharge capacity up to 100 kA (10/350  $\mu$ s)
- All-in-one protection unit, ready for connection
- Mounting on 35 mm DIN rail (EN 60715)
- Degree of protection according to IEC EN 60529: IP 20
- Inflammability class according to UL 94 V0
- EAC certification
- Remote signalling contact (FM): break contact
- Switching capacity FM: 250 V/2 A
- Max. conductor cross section FM: 1,5 mm<sup>2</sup>

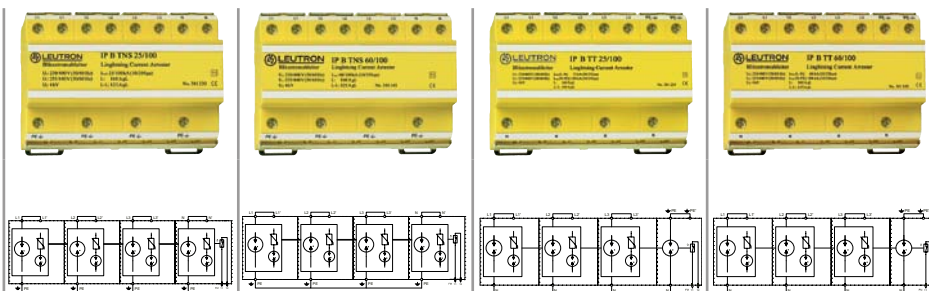

#### Technical Data

Product name	IP B TNS 25/100/FM	IP B TNS 60/100/FM	IP B TT 25/100/FM	IP B TT 60/100/FM
Article-No.	38 12 21	38 11 46	38 12 25	38 11 51
IEC category	Type 1 / class I	Type 1 / class I	Type 1 / class I	Type 1 / class I
Nominal voltage AC	UN 230/400 V~	230/400 V~	230/400 V~	230/400 V~
Max. continuous operating voltage AC (50/60 Hz)	Uc 255 V~	255 V~	255 V~	255 V~
Insulation resistance	Risol >10 G $\Omega$	>10 G $\Omega$	>10 G $\Omega$	>10 G $\Omega$
Protection level at 100% lightning imp. sparkover voltage (1.2/50 $\mu$ s)	Up $\leq$ 4,0 kV	$\leq$ 4,0 kV	$\leq$ 4,0 kV	$\leq$ 4,0 kV
Protection level	Up $\leq$ 4,0 kV	$\leq$ 4,0 kV	$\leq$ 4,0 kV	$\leq$ 4,0 kV
Response time	tA <50 ns	<50 ns	<50 ns	<50 ns
Lightning impulse current (10/350 $\mu$ s) total	Itotal 100 kA	100 kA	100 kA	100 kA
Lightning impulse current (10/350 $\mu$ s) L-N/PE/L-PEN Iimp	25 / 25 / - kA	60 / 60 / - kA	25 / 100 / - kA	60 / 100 / - kA
Short-circuit withstand capability at max. back-up fuse	I <sub>k</sub> 50 kAeff	50 kAeff	50 kAeff	50 kAeff
Max. acceptable back-up fuse F2 (spur wiring)	160 A gG	160 A gG	160 A gG	160 A gG
Max. acceptable back-up fuse F1 (serial wiring)	125 A gG	125 A gG	125 A gG	125 A gG
Operating temperature range	TU -40 - +80 °C	-40 - +80 °C	-40 - +80 °C	-40 - +80 °C
Max. conductor cross section	50mm <sup>2</sup> stranded/35mm <sup>2</sup> flexible	50mm <sup>2</sup> stranded/35mm <sup>2</sup> flexible	50mm <sup>2</sup> stranded/35mm <sup>2</sup> flexible	50mm <sup>2</sup> stranded/35mm <sup>2</sup> flexible
Recommended conductor cross section	25 mm <sup>2</sup>	25 mm <sup>2</sup>	25 mm <sup>2</sup>	25 mm <sup>2</sup>
Max. connection torque for terminals	4,0 Nm	4,0 Nm	4,0 Nm	4,0 Nm
Enclosure material / colour	Polycarbonate/yellow	Polycarbonate/yellow	Polycarbonate/yellow	Polycarbonate/yellow
Power supply system	3 phase TNS systems	3 phase TNS systems	3 phase TT systems	3 phase TT systems



### Lightning current arrester type 1 for AC power supplies / IsoPro

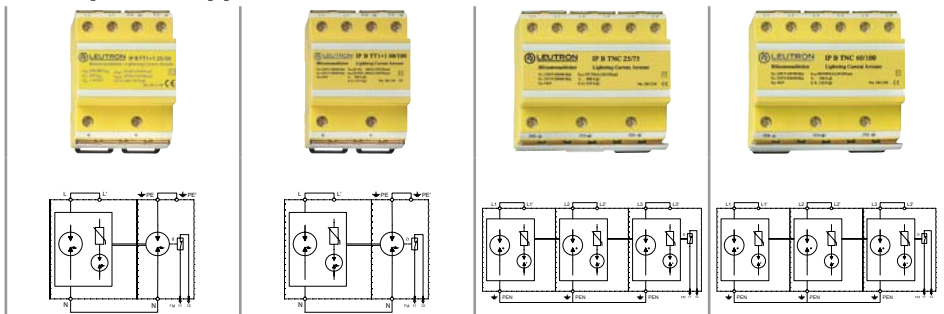

#### Technical Data

Product name	IP B TT1+1 25/50/FM	IP B TT1+1 60/100/FM	IP B TNC 25/75/FM	IP B TNC 60/100/FM
Article-No.	38 12 29	38 11 56	38 12 17	38 11 41
IEC category	Type 1 / class I	Type 1 / class I	Type 1 / class I	Type 1 / class I
Nominal voltage AC	UN 230/400 V~	230/400 V~	230/400 V~	230/400 V~
Max. continuous operating voltage AC (50/60 Hz)	Uc 255 V~	255 V~	255 V~	255 V~
Insulation resistance	Risol >10 GΩ	>10 GΩ	>10 GΩ	> 10 GΩ
Protection level at 100% lightn. imp. sparkover voltage (1.2/50μs)	Up ≤ 4,0 kV	≤ 4,0 kV	≤ 4,0 kV	≤ 4,0 kV
Protection level	Up ≤ 4,0 kV	≤ 4,0 kV	≤ 4,0 kV	≤ 4,0 kV
Response time	tA <50 ns	<50 ns	< 50 ns	<50 ns
Lightning impulse current (10/350 μs) total	Itotal 50 kA	100 kA	75 kA	100 kA
Lightning impulse current (10/350 μs) L-N/N-PE/L-PEN	Iimp 25 / 50 / - kA	60 / 100 / - kA	- / - / 25 kA	- / - / 60 kA
Short-circuit withstand capability at max. back-up fuse	I <sub>k</sub> 50 kA <sub>eff</sub>	50 kA <sub>eff</sub>	50 kA <sub>eff</sub>	50 kA <sub>eff</sub>
Max. acceptable back-up fuse F2 (spur wiring)	160 A gG	160 A gG	160 A gG	160 A gG
Max. acceptable back-up fuse F1 (serial wiring)	125 A gG	125 A gG	125 A gG	125 A gG
Operating temperature range	TU -40 - +80 °C	-40 - +80 °C	-40 - +80 °C	-40 - +80 °C
Max. conductor cross section	50mm <sup>2</sup> stranded/35mm <sup>2</sup> flexible	50mm <sup>2</sup> stranded/35mm <sup>2</sup> flexible	50mm <sup>2</sup> stranded/35mm <sup>2</sup> flexible	50mm <sup>2</sup> stranded/35mm <sup>2</sup> flexible
Recommended conductor cross section	25 mm <sup>2</sup>	25 mm <sup>2</sup>	25 mm <sup>2</sup>	25 mm <sup>2</sup>
Max. connection torque for terminals	4,0 Nm	4,0 Nm	4,0 Nm	4,0 Nm
Enclosure material / colour	Polycarbonate/yellow	Polycarbonate/yellow	Polycarbonate/yellow	Polycarbonate/yellow
Power supply system	1 phase TT systems	1 phase TT systems	3 phase TNC systems	3 phase TNC systems

#### Dimensions

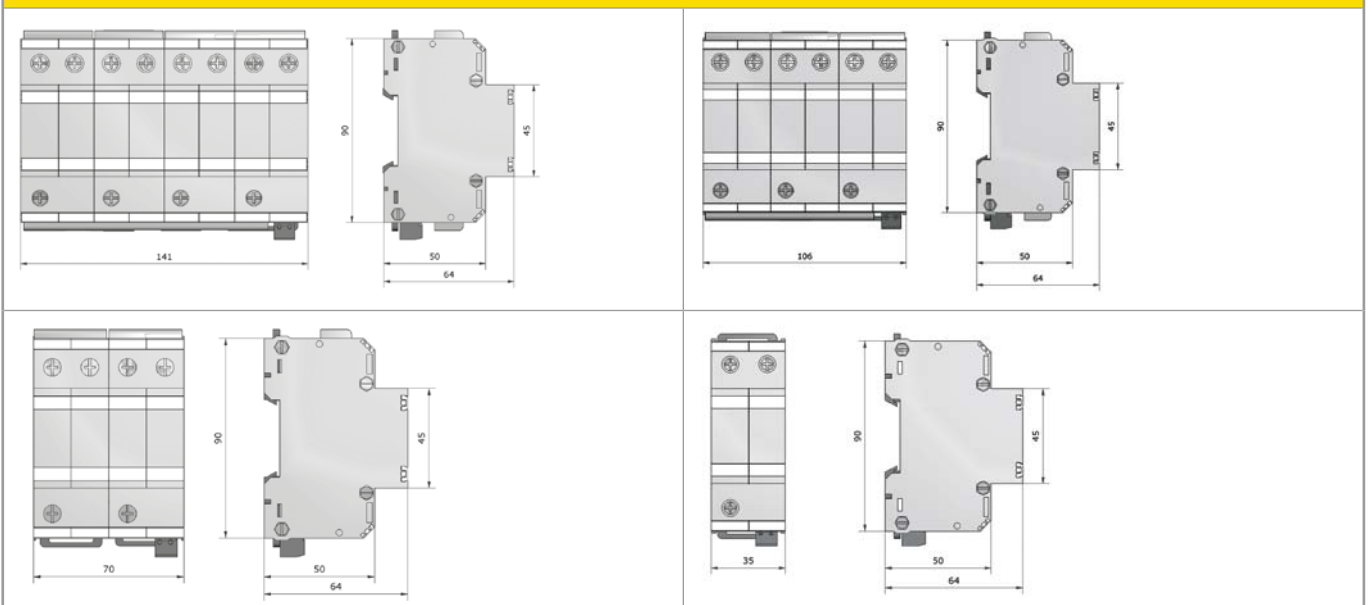



### Lightning current arrester type 1 for AC power supplies / IsoPro

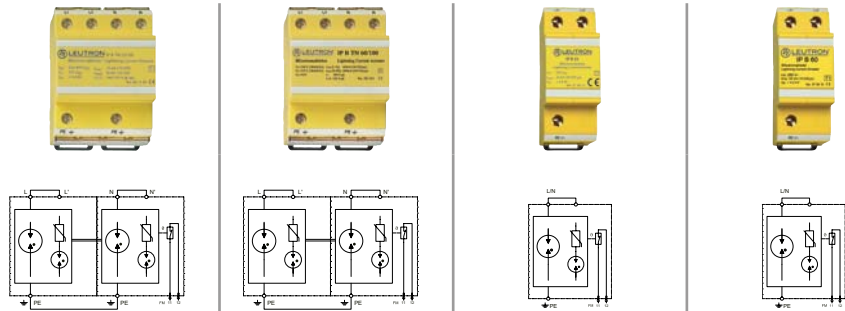

#### Technical Data

Product name	IP B TN 25/50/FM	IP B TN 60/100/FM	IP B 25/FM	IP B 60/FM
Article-No.	38 12 37	38 12 33	55 05 00	55 04 95
IEC category	Type 1 / class I	Type 1 / class I	Type 1 / class I	Type 1 / class I
Nominal voltage AC	UN 230/400 V~	230/400 V~	230/400 V~	230/400 V~
Max. continuous operating voltage AC (50/60 Hz)	Uc 255 V~	255 V~	255 V~	255 V~
Insulation resistance	Risol >10 GΩ	>10 GΩ	> 10 GΩ	> 10 GΩ
Protection level at 100% lightn. imp. sparkover voltage (1.2/50μs)	Up ≤ 4,0 kV	≤ 4,0 kV	≤ 4,0 kV	≤ 4,0 kV
Protection level	Up ≤ 4,0 kV	≤ 4,0 kV	≤ 4,0 kV	≤ 4,0 kV
Response time	tA <50 ns	<50 ns	< 50 ns	< 50 ns
Lightning impulse current (10/350 μs) total	Itotal 50 kA	100 kA	25 kA	60 kA
Lightning impulse current (10/350 μs) L-N/N-PE/L-PEN Iimp	25 / 25 / - kA	- / 60 / - kA	25 / - / - kA (L,N-PE)	60 / - / - kA (L,N-PE)
Short-circuit withstand capability at max. back-up fuse	I <sub>lk</sub> 50 kAeff	50 kAeff	50 kAeff	50 kAeff
Max. acceptable back-up fuse F2 (spur wiring)	160 A gG	160 A gG	160 A gG	160 A gG
Max. acceptable back-up fuse F1 (serial wiring)	125 A gG	125 A gG	125 A gG	125 A gG
Operating temperature range	TU -40 - +80 °C	-40 - +80 °C	-40 - +80 °C	-40 - +80 °C
Max. conductor cross section	50mm <sup>2</sup> stranded/35mm <sup>2</sup> flexible	50mm <sup>2</sup> stranded/35mm <sup>2</sup> flexible	50mm <sup>2</sup> stranded/35mm <sup>2</sup> flexible	50mm <sup>2</sup> stranded/35mm <sup>2</sup> flexible
Recommended conductor cross section	25 mm <sup>2</sup>	25 mm <sup>2</sup>	25 mm <sup>2</sup>	25 mm <sup>2</sup>
Max. connection torque for terminals	4,0 Nm	4,0 Nm	4,0 Nm	4,0 Nm
Enclosure material / colour	Polycarbonate/yellow	Polycarbonate/yellow	Polycarbonate/yellow	Polycarbonate/yellow
Power supply system	1 phase TN systems	1 phase TN systems	between L and N	between L and N

#### Accessories

Article-No.	DAK 2x 16 17 01 10
-------------	-----------------------



Pin-shaped terminal to enable feed-through wiring (serial wiring) for all surge protection modules with only one clamp per phase.



## Combined arrester type 1 + 2 for AC power supplies / IsoPro

### IsoPro BC

Multipole lightning current arrester type 1 + 2 for the use in 1, 2 and 3 phase TNS, TT, TNC, TN and IT systems, for protection of low-voltage consumers' installations in business and residential areas against surges caused by lightning or switching actions in the network. The arresters can be installed at the transition OA to 2 according to the lightning protection zones concept.



example image

- Test standard: IEC 61643-11 / EN 61643-11
- All-in-one protection unit, ready for connection
- No leakage currents, thus, allowing installation upstream of power meters
- Degree of protection according to IEC EN 60529: IP 20
- Mounting on 35 mm DIN rail (EN 60715)
- Inflammability class according to UL 94 V0
- EAC certification
- Remote signalling contact: break contact
- Switching capacity FM: 250 V/2 A
- Max. conductor cross section FM: 1,5 mm<sup>2</sup>

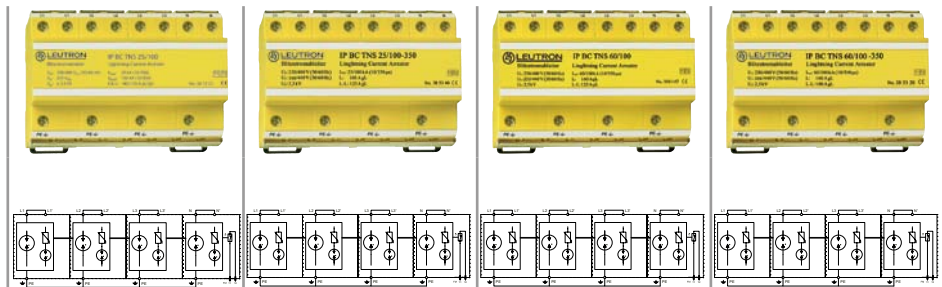

#### Technical Data

Product name	IP BC TNS 25/100/FM	IP BC TNS 25/100/FM-350	IP BC TNS 60/100/FM	IP BC TNS 60/100/FM-350
Article-No.	38 12 23	38 53 50	38 11 48	38 53 30
IEC category	Type 1 + 2 / class I+II	Type 1 + 2 / class I+II	Type 1 + 2 / class I+II	Type 1 + 2 / class I+II
Nominal voltage AC	UN 230/400 V~	230/400 V~	230/400 V~	230/400 V~
Max. continuous operating voltage AC (50/60Hz)	Uc 255 V~	350 V~	255 V~	350 V~
Insulation resistance	Risol >10 GΩ	> 10 GΩ	>10 GΩ	>10 GΩ
Protection level at 100% lightning imp. sparkover voltage (1.2/50µs)	Up ≤ 2,5 kV	≤ 2.5 kV	≤ 2,5 kV	≤ 2,5 kV
Protection level	Up ≤ 2,5 kV	≤ 2.5 kV	≤ 2,5 kV	≤ 2,5 kV
Response time	tA <50 ns	< 50 ns	<50 ns	<50 ns
Lightning impulse current (10/350 µs) total	Itotal 100 kA	100 kA	100 kA	100 kA
Lightning impulse current (10/350 µs) L-N/N-PE/L-PEN	limp 25 / 25 / - kA	25 / 25 / - kA	60 / 60 / - kA	60 / 60 / - kA
Short-circuit withstand capability at max. back-up fuse	I <sub>k</sub> 50 kAeff	50 kAeff	50 kAeff	50 kAeff
Max. acceptable back-up fuse F2 (spur wiring)	160 A gG	160 A gG	160 A gG	160 A gG
Max. acceptable back-up fuse F1 (serial wiring)	125 A gG	125 A gG	125 A gG	125 A gG
Operating temperature range	TU -40 - +80 °C	-40 - +80 °C	-40 - +80 °C	-40 - +80 °C
Max. conductor cross section	50mm <sup>2</sup> stranded/35mm <sup>2</sup> flexible	50mm <sup>2</sup> stranded/35mm <sup>2</sup> flexible	50mm <sup>2</sup> stranded/35mm <sup>2</sup> flexible	50mm <sup>2</sup> stranded/35mm <sup>2</sup> flexible
Recommended conductor cross section	25 mm <sup>2</sup>	25 mm <sup>2</sup>	25 mm <sup>2</sup>	25 mm <sup>2</sup>
Max. connection torque for terminals	4,0 Nm	4,0 Nm	4,0 Nm	4,0 Nm
Enclosure material / colour	Polycarbonate/yellow	Polycarbonate/yellow	Polycarbonate/yellow	Polycarbonate/yellow
Power supply system	3 phase TNS systems	3 phase TNS systems	3 phase TNS systems	3 phase TNS systems



### Combined arrester type 1 + 2 for AC power supplies / IsoPro

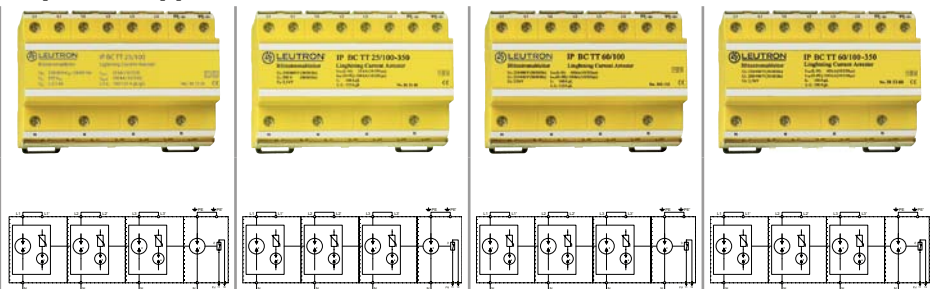

#### Technical Data

Product name	IP BC TT 25/100/FM	IP BC TT 25/100/FM-350	IP BC TT 60/100/FM	IP BC TT 60/100/FM-350
Article-No.	38 12 27	38 53 90	38 11 54	38 53 70
IEC category	Type 1 + 2 / class I+II	Type 1 + 2 / class I+II	Type 1 + 2 / class I+II	Type 1 + 2 / class I+II
Nominal voltage AC	UN 230/400 V~	230/400 V~	230/400 V~	230/400 V~
Max. continuous operating voltage AC (50/60Hz)	Uc 255 V~	350 V~	255 V~	350 V~
Insulation resistance	Risol >10 GΩ	> 10 GΩ	>10 GΩ	>10 GΩ
Protection level at 100% lightn. imp. sparkover voltage (1.2/50μs)	Up ≤ 2,5 kV	≤ 2,5 kV	≤ 2,5 kV	≤ 2,5 kV
Protection level	Up ≤ 2,5 kV	≤ 2,5 kV	≤ 2,5 kV	≤ 2,5 kV
Response time	tA <50 ns	< 50 ns	<50 ns	<50 ns
Lightning impulse current (10/350 μs) total	Itotal 100 kA	100 kA	100 kA	100 kA
Lightning impulse current (10/350 μs) L-N/N-PE/L-PEN limp	25 / 100 / - kA	25 / 100 / - kA	60 / 100 / - kA	60 / 100 / - kA
Short-circuit withstand capability at max. back-up fuse	Ik 50 kAeff	50 kAeff	50 kAeff	50 kAeff
Max. acceptable back-up fuse F2 (spur wiring)	160 A gG	160 A gG	160 A gG	160 A gG
Max. acceptable back-up fuse F1 (serial wiring)	125 A gG	125 A gG	125 A gG	125 A gG
Operating temperature range	TU -40 - +80 °C	-40 - +80 °C	-40 - +80 °C	-40 - +80 °C
Max. conductor cross section	50mm <sup>2</sup> stranded/35mm <sup>2</sup> flexible	50mm <sup>2</sup> stranded/35mm <sup>2</sup> flexible	50mm <sup>2</sup> stranded/35mm <sup>2</sup> flexible	50mm <sup>2</sup> stranded/35mm <sup>2</sup> flexible
Recommended conductor cross section	25 mm <sup>2</sup>	25 mm <sup>2</sup>	25 mm <sup>2</sup>	25 mm <sup>2</sup>
Max. connection torque for terminals	4,0 Nm	4,0 Nm	4,0 Nm	4,0 Nm
Enclosure material / colour	Polycarbonate/yellow	Polycarbonate/yellow	Polycarbonate/yellow	Polycarbonate/yellow
Power supply system	3 phase TT systems	3 phase TT systems	3 phase TT systems	3 phase TT systems

#### Dimensions

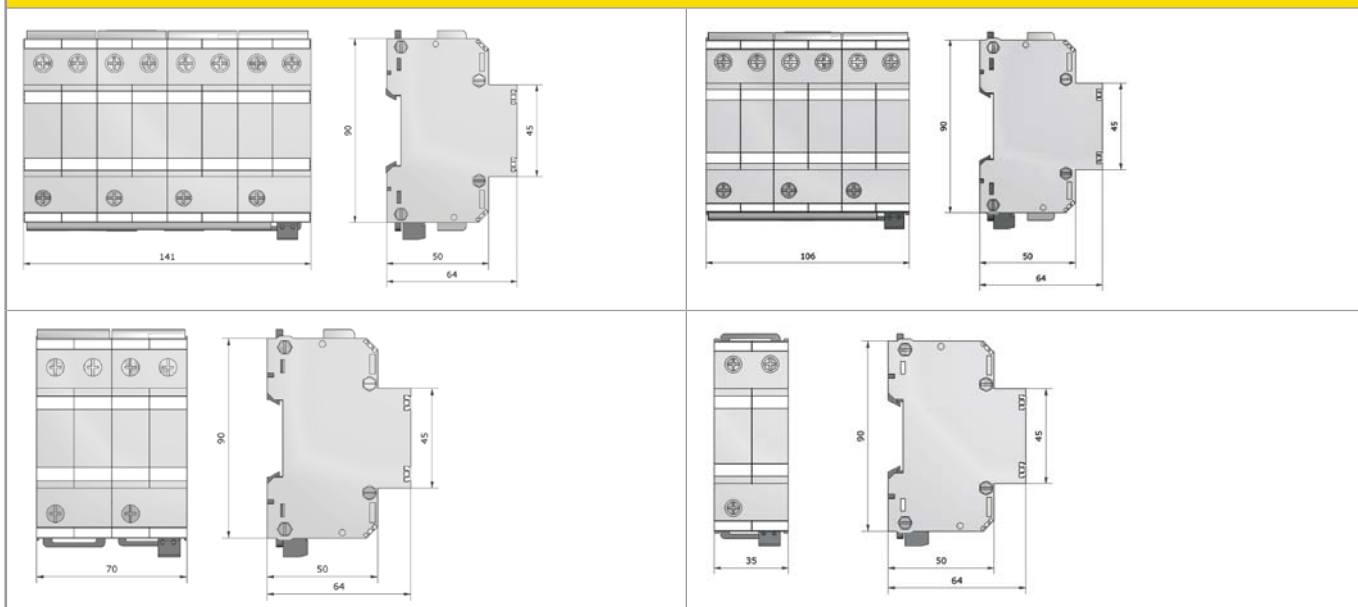





## Combined arrester type 1 + 2 for AC power supplies / IsoPro

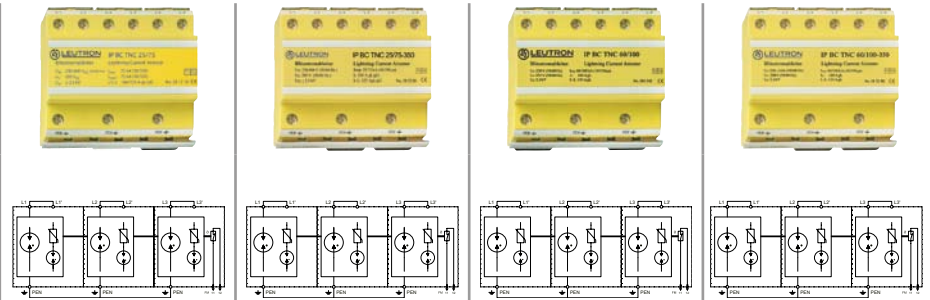

### Technical Data

Product name	IP BC TNC 25/75/FM	IP BC TNC 25/75/FM-350	IP BC TNC 60/100/FM	IP BC TNC 60/100/FM-350
Article-No.	38 12 19	38 53 10	38 11 43	38 52 90
IEC category	Type 1 + 2 / class I+II	Type 1 + 2 / class I+II	Type 1 + 2 / class I+II	Type 1 + 2 / class I+II
Nominal voltage AC	UN 230/400 V~	230/400 V~	230/400 V~	230/400 (250/440) V~
Max. continuous operating voltage AC (50/60 Hz)	Uc 255 V~	350 V~	255 V~	350 V~
Insulation resistance	Risol >10 GΩ	>10 GΩ	>10 GΩ	> 10 GΩ
Protection level at 100% lightn. imp. sparkover voltage (1.2/50μs)	Up ≤ 2,5 kV	≤ 2,5 kV	≤ 2,5 kV	≤ 2,5 kV
Protection level	Up ≤ 2,5 kV	≤ 2,5 kV	≤ 2,5 kV	≤ 2,5 kV
Response time	tA <50 ns	<50 ns	<50 ns	< 50 ns
Lightning impulse current (10/350 μs) total	Itotal 75 kA	75 kA	100 kA	100 kA
Lightning impulse current (10/350 μs) L-N/N-PE/L-PEN Iimp	- / - / 25 kA	- / - / 25 kA	- / - / 60 kA	- / - / 60 kA
Short-circuit withstand capability at max. back-up fuse	I <sub>k</sub> 50 kAeff	50 kAeff	50 kAeff	50 kAeff
Max. acceptable back-up fuse F2 (spur wiring)	160 A gG	160 A gG	160 A gG	160 A gG
Max. acceptable back-up fuse F1 (serial wiring)	125 A gG	125 A gG	125 A gG	125 A gG
Operating temperature range	TU -40 - +80 °C	-40 - +80 °C	-40 - +80 °C	-40 - +80 °C
Max. conductor cross section	50mm <sup>2</sup> stranded/35mm <sup>2</sup> flexible	50mm <sup>2</sup> stranded/35mm <sup>2</sup> flexible	50mm <sup>2</sup> stranded/35mm <sup>2</sup> flexible	50mm <sup>2</sup> stranded/35mm <sup>2</sup> flexible
Recommended conductor cross section	25 mm <sup>2</sup>	25 mm <sup>2</sup>	25 mm <sup>2</sup>	10/25 mm <sup>2</sup>
Max. connection torque for terminals	4,0 Nm	4,0 Nm	4,0 Nm	4,0 Nm
Enclosure material / colour	Polycarbonate/yellow	Polycarbonate/yellow	Polycarbonate/yellow	Polycarbonate/yellow
Power supply system	3 phase TNC systems	3 phase TNC systems	3 phase TNC systems	3 phase TNC systems



### Combined arrester type 1 + 2 for AC power supplies / IsoPro

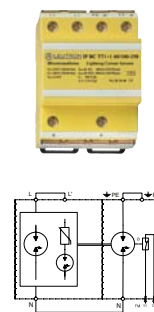
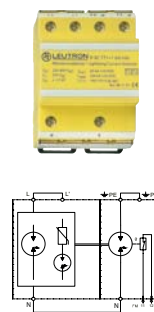
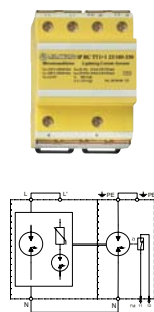
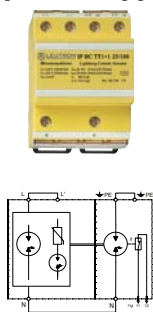

#### Technical Data

Product name	IP BC TT1+1 25/100/FM	IP BC TT1+1 25/100/FM-350	IP BC TT1+1 60/100/FM	IP BC TT1+1 60/100/FM-350
Article-No.	38 12 31	38 54 70	38 11 58	38 54 50
IEC category	Type 1 + 2 / class I+II	Type 1 + 2 / class I+II	Type 1 + 2 / class I+II	Type 1 + 2 / class I+II
Nominal voltage AC	UN 230/400 V~	230/400 V~	230/400 V~	230/400 V~
Max. continuous operating voltage AC (50/60Hz)	Uc 255 V~	350 V~	255 V~	350 V~
Insulation resistance	Risol >10 GΩ	> 10 GΩ	>10 GΩ	>10 GΩ
Protection level at 100% lightn. imp. sparkover voltage (1.2/50μs)	Up ≤ 2,5 kV	≤ 2.5 kV	≤ 2,5 kV	≤ 2,5 kV
Protection level	Up ≤ 2,5 kV	≤ 2,5 kV	≤ 2,5 kV	≤ 2,5 kV
Response time	tA < 50 ns	< 50 ns	< 50 ns	< 50 ns
Lightning impulse current (10/350 μs) total	Itotal 100 kA	100 kA	100 kA	100 kA
Lightning impulse current (10/350 μs) L-N/N-PE/L-PEN Iimp	25 / 100 / - kA	25 / 100 / - kA	60 / 100 / - kA	60 / 100 / - kA
Short-circuit withstand capability at max. back-up fuse Iik	50 kAeff	50 kAeff	50 kAeff	50 kAeff
Max. acceptable back-up fuse F2 (spur wiring)	160 A gG	160 A gG	160 A gG	160 A gG
Max. acceptable back-up fuse F1 (serial wiring)	125 A gG	125 A gG	125 A gG	125 A gG
Operating temperature range	TU -40 - +80 °C	-40 - +80 °C	-40 - +80 °C	-40 - +80 °C
Max. conductor cross section	50mm <sup>2</sup> stranded/35mm <sup>2</sup> flexible	50mm <sup>2</sup> stranded/35mm <sup>2</sup> flexible	50mm <sup>2</sup> stranded/35mm <sup>2</sup> flexible	50mm <sup>2</sup> stranded/35mm <sup>2</sup> flexible
Recommended conductor cross section	25 mm <sup>2</sup>	25 mm <sup>2</sup>	25 mm <sup>2</sup>	25 mm <sup>2</sup>
Max. connection torque for terminals	4,0 Nm	4,0 Nm	4,0 Nm	4,0 Nm
Enclosure material / colour	Polycarbonate/yellow	Polycarbonate/yellow	Polycarbonate/yellow	Polycarbonate/yellow
Power supply system	1 phase TT systems	1 phase TT systems	1 phase TT systems	1 phase TT systems



## Combined arrester type 1 + 2 for AC power supplies / IsoPro

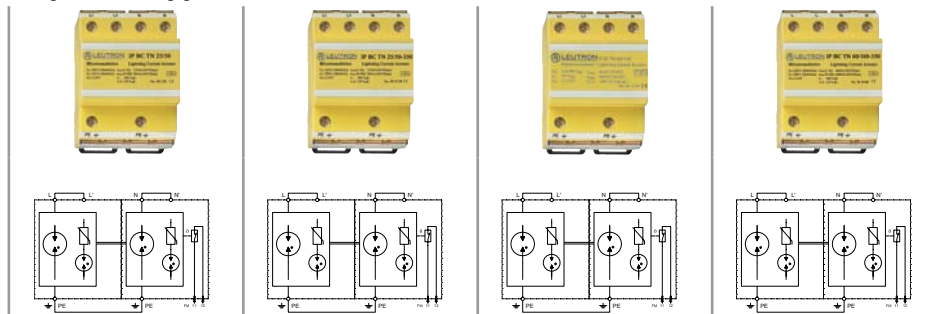

### Technical Data

Product name	IP BC TN 25/50/FM	IP BC TN 25/50/FM-350	IP BC TN 60/100/FM	IP BC TN 60/100/FM-350
Article-No.	38 12 39	38 54 30	38 12 35	38 54 10
IEC category	Type 1 + 2 / class I+II	Type 1 + 2 / class I+II	Type 1 + 2 / class I+II	Type 1 + 2 / class I+II
Nominal voltage AC	UN 230/400 V~	230/400 V~	230/400 V~	230/400 V~
Max. continuous operating voltage AC (50/60 Hz)	Uc 255 V~	350 V~	255 V~	350 V~
Insulation resistance	Risol >10 GΩ	> 10 GΩ	>10 GΩ	>10 GΩ
Protection level at 100% lightn. imp. sparkover voltage (1.2/50μs)	Up ≤ 2,5 kV	≤ 2.5 kV	≤ 2,5 kV	≤ 2,5 kV
Protection level	Up ≤ 2,5 kV	≤ 2.5 kV	≤ 2,5 kV	≤ 2,5 kV
Response time	tA <50 ns	50 ns	<50 ns	<50 ns
Lightning impulse current (10/350 μs) total	Itotal 50 kA	50 kA	100 kA	100 kA
Lightning impulse current (10/350 μs) L-N/N-PE/L-PEN Iimp	25 / 25 / - kA	25 / 25 / - kA	60 / 60 / - kA	60 / 60 / - kA
Short-circuit withstand capability at max. back-up fuse	I <sub>k</sub> 50 kA <sub>eff</sub>	50 kA <sub>eff</sub>	50 kA <sub>eff</sub>	50 kA <sub>eff</sub>
Max. acceptable back-up fuse F2 (spur wiring)	160 A gG	160 A gG	160 A gG	160 A gG
Max. acceptable back-up fuse F1 (serial wiring)	125 A gG	125 A gG	125 A gG	125 A gG
Operating temperature range	TU -40 - +80 °C	-40 - +80 °C	-40 - +80 °C	-40 - +80 °C
Max. conductor cross section	50mm <sup>2</sup> stranded/35mm <sup>2</sup> flexible	50mm <sup>2</sup> stranded/35mm <sup>2</sup> flexible	50mm <sup>2</sup> stranded/35mm <sup>2</sup> flexible	50mm <sup>2</sup> stranded/35mm <sup>2</sup> flexible
Recommended conductor cross section	25 mm <sup>2</sup>	25 mm <sup>2</sup>	25 mm <sup>2</sup>	25 mm <sup>2</sup>
Max. connection torque for terminals	4,0 Nm	4,0 Nm	4,0 Nm	4,0 Nm
Enclosure material / colour	Polycarbonate/yellow	Polycarbonate/yellow	Polycarbonate/yellow	Polycarbonate/yellow
Power supply system	1 phase TN systems	1 phase TN systems	1 phase TN systems	1 phase TN systems



### Combined arrester type 1 + 2 for AC power supplies / IsoPro

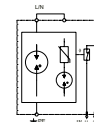
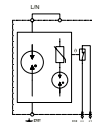
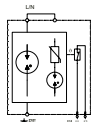
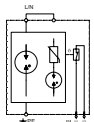

#### Technical Data

Product name	IP BC 25/FM	IP BC 25/FM-350	IP BC 60/FM	IP BC 60/FM-350
Article-No.	37 38 26	55 05 19	55 05 18	55 05 21
IEC category	Type 1 + 2 / class I+II	Type 1 + 2 / class I+II	Type 1 + 2 / class I+II	Type 1 + 2 / class I+II
Nominal voltage AC	UN 230/400 V~	230/400 - 240/415 V~	230/400 V~	230/400 V~
Max. continuous operating voltage AC (50/60Hz)	Uc 255 V~	350 V~	255 V~	350 V~
Insulation resistance	Risol >10 GΩ	>10 GΩ	>10 GΩ	>10 GΩ
Protection level at 100% lightn. imp. sparkover voltage (1.2/50μs)	Up ≤ 2,5 kV	≤ 2,5 kV	≤ 2,5 kV	≤ 2,5 kV
Protection level	Up ≤ 2,5 kV	≤ 2,5 kV	≤ 2,5 kV	≤ 2,5 kV
Response time	tA <50 ns	<50 ns	<50 ns	<50 ns
Lightning impulse current (10/350 μs) total	Itotal 25 kA	25 kA	60 kA	60 kA
Lightning impulse current (10/350 μs) L-N/N-PE/L-PEN Iimp	25 / - / - kA	25 / - / - kA	60 / - / - kA	60 / - / - kA
Short-circuit withstand capability at max. back-up fuse	I <sub>k</sub> 50 kAeff	50 kAeff	50 kAeff	50 kAeff
Max. acceptable back-up fuse F2 (spur wiring)	160 A gG	160 A gG	160 A gG	160 A gG
Max. acceptable back-up fuse F1 (serial wiring)	125 A gG	125 A gG	125 A gG	125 A gG
Operating temperature range	TU -40 - +80 °C	-40 - +80 °C	-40 - +80 °C	-40 - +80 °C
Max. conductor cross section	50mm <sup>2</sup> stranded/35mm <sup>2</sup> flexible	50mm <sup>2</sup> stranded/35mm <sup>2</sup> flexible	50mm <sup>2</sup> stranded/35mm <sup>2</sup> flexible	50mm <sup>2</sup> stranded/35mm <sup>2</sup> flexible
Recommended conductor cross section	25 mm <sup>2</sup>	25 mm <sup>2</sup>	25 mm <sup>2</sup>	25 mm <sup>2</sup>
Max. connection torque for terminals	4,0 Nm	4,0 Nm	4,0 Nm	4,0 Nm
Enclosure material / colour	Polycarbonate/yellow	Polycarbonate/yellow	Polycarbonate/yellow	Polycarbonate/yellow
Power supply system	between L and N	between L and N	between L and N	between L and N



### Combined arrester type 1 + 2 for AC power supplies / IsoPro

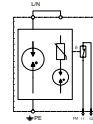
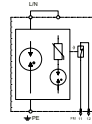
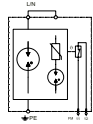

#### Technical Data

Product name	IP BC 60/FM-440	IP BC 60/FM-350 2kV	IP BC 25/FM-350 2kV
Article-No.	55 05 41	55 05 23	55 05 27
IEC category	Type 1 + 2 / class I+II	Type 1 + 2 / class I+II	Type 1 + 2 / class I+II
Nominal voltage AC	UN 250/440 - 400/690 V~	230/400 - 240/415 V~	230/400 - 240/415 V~
Max. continuous operating voltage AC (50/60Hz)	Uc 440 V~	350 V~	350 V~
Insulation resistance	Risol >10 GΩ	>10 GΩ	>10 GΩ
Protection level at 100% lightn. imp. sparkover voltage (1.2/50μs)	Up ≤ 2,5 kV	≤ 2,0 kV	≤ 2,0 kV
Protection level	Up ≤ 2,5 kV	≤ 2,0 kV	≤ 2,0 kV
Response time	tA <50 ns	<50 ns	<50 ns
Lightning impulse current (10/350 μs) total	Itotal 60 kA	60 kA	25 kA
Lightning impulse current (10/350 μs) L-N/N-PE/L-PEN	limp 60 / - / - kA	60 / - / - kA	25 / - / - kA
Short-circuit withstand capability at max. back-up fuse	Ik 50 kAeff	50 kAeff	50 kAeff
Max. acceptable back-up fuse F2 (spur wiring)	160 A gG	160 A gG	160 A gG
Max. acceptable back-up fuse F1 (serial wiring)	125 A gG	125 A gG	125 A gG
Operating temperature range	TU -40 - +80 °C	-40 - +80 °C	-40 - +80 °C
Max. conductor cross section	50mm <sup>2</sup> stranded/35mm <sup>2</sup> flexible	50mm <sup>2</sup> stranded/35mm <sup>2</sup> flexible	50mm <sup>2</sup> stranded/35mm <sup>2</sup> flexible
Recommended conductor cross section	25 mm <sup>2</sup>	25 mm <sup>2</sup>	25 mm <sup>2</sup>
Max. connection torque for terminals	4,0 Nm	4,0 Nm	4,0 Nm
Enclosure material / colour	Polycarbonate/yellow	Polycarbonate/yellow	Polycarbonate/yellow
Power supply system	between L and N	between L and N	between L and N

#### Accessories

Article-No.	DAK 2x 16 17 01 10
-------------	-----------------------



Pin-shaped terminal to enable feed-through wiring (serial wiring) for all surge protection modules with only one clamp per phase.



### Combined arrester type 1 + 2 for AC power supplies / IsoPro

#### IsoPro BC LED

Combined multi-pole arrester for 3 phase TT systems.



- Test standard: IEC 61643-11 / EN 61643-11
- Arrester status control display: LED green (readiness: on)
- Not leakage current free
- 4 pole; 3+1 NPE
- All-in-one protection unit, ready for connection
- Mounting on 35 mm DIN rail (EN 60715)
- Inflammability class according to UL 94 V0
- EAC certification
- Remote signalling contact (FM): break contact
- Switching capacity FM: 250 V/2 A
- Max. conductor cross section FM: 1,5 mm<sup>2</sup>

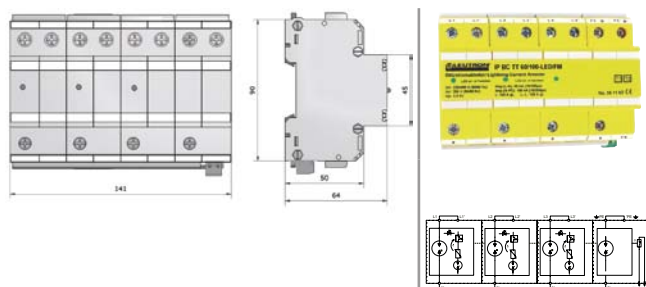

#### Technical Data

Product name	IP BC TT 60/100-LED/FM	
Article-No.	38 11 63	
IEC category	Type 1 + 2 / class I+II	
Nominal voltage AC	UN	230/400 V~
Max. continuous operating voltage AC (50/60 Hz)	Uc	255 V~
Insulation resistance	Risol	>10 GΩ
Protection level at 100% lightn. imp. sparkover voltage (1.2/50µs)	Up	≤ 2,5 kV
Protection level	Up	≤ 2,5 kV
Response time	tA	<50 ns
Lightning impulse current (10/350 µs) total	Itotal	100 kA
Lightning impulse current (10/350 µs) L-N/N-PE/L-PEN limp		60 / 100 / - kA
Short-circuit withstand capability at max. back-up fuse	Ik	50 kAeff
Max. acceptable back-up fuse F2 (spur wiring)		160 A gG
Max. acceptable back-up fuse F1 (serial wiring)		125 A gG
Operating temperature range	TU	-40 - +80 °C
Max. conductor cross section		50mm <sup>2</sup> stranded/35mm <sup>2</sup> flexible
Recommended conductor cross section		25 mm <sup>2</sup>
Max. connection torque for terminals		4,0 Nm
Enclosure material / colour		Polycarbonate/yellow
Power supply system		3 phase TT systems



## Combined arrester type 1 + 2 for AC power supplies / EnerProS

### EnerPro S pluggable

Combined multi-pole and pluggable arrester e. g. for 3 phase TNS, TT and TNC systems. Mechanical status indicator: State of the surge protective device is optically indicated.



example image

- Test standard: IEC 61643-11 / EN 61643-11
- Place of installation: Main distributor
- High lightning impulse discharge current of 12.5 kA (10/350  $\mu$ s) per pole
- Mounting on 35 mm DIN rail (EN 60715)
- With remote signalling contact (FM): changeover contact
- Switching capacity FM: AC: 250V, 125V:1A / DC: 48V, 24V, 12V: 0,5A
- Max. conductor cross section FM: 1,5 mm<sup>2</sup>

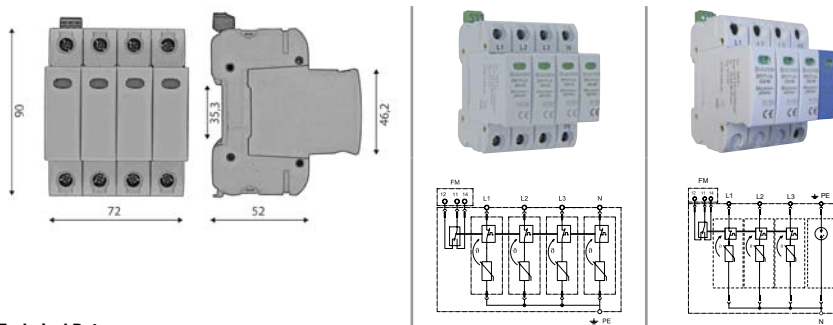

#### Technical Data

Product name	EPS T1+2/4+0-320-12.5-FM	EPS T1+2/3+1-320-12.5-FM
Article-No.	38 07 03	38 07 01
IEC category	Type 1 + 2 / class I+II	Type 1 + 2 / class I+II
Nominal voltage AC	UN 240 V~	240 V~
Max. continuous operating voltage AC (50/60 Hz)	Uc 320 V~	320 V~
Nominal discharge current (8/20 $\mu$ s) L-N/N-PE/L-PEN	In 25 / - / - kA	20 / 50 / - kA
Max. imp. discharge current (8/20 $\mu$ s) L-N/N-PE/L-PEN I <sub>max</sub>	50 / - / - kA	50 / 100 / - kA
Lightning impulse current (10/350 $\mu$ s) L-N/N-PE/L-PEN I <sub>imp</sub>	12,5 / - / - kA	12,5 / 50 / - kA
Specific Energy	W/R 39 kJ/ $\Omega$	39 (L-N) / 625 (N-PE) kJ/ $\Omega$
Charge	Q 6,25 As	6,25 (L-N) / 25 (N-PE) As
Protection level	Up < 1,5 kV	$\leq 1,5$ (MOV)/ $\leq 1,5$ (GDT) kV
Response time	tA < 25 ns	25 (MOV)/100 (GDT) ns
Max. allowed fuse or back-up fuse	250 A gG	250 A gG
Short-circuit withstand capability at max. back-up fuse	I <sub>k</sub> 25/50 kA <sub>eff</sub>	25/50 kA <sub>eff</sub>
Follow-on current extinguishing capability AC N-PE	-	100 A <sub>eff</sub>
Temporary overvoltage rating 120 min	442 V	442 V
Operating temperature range	TU -40 - +85°C	-40 - +85°C
Max. conductor cross section	stranded 35/fine stranded 25 mm <sup>2</sup>	
Max. connection torque for terminals	4,5 Nm	4,5 Nm
Enclosure material / colour	Thermoplastic: Extinguishing Degree UL 94 V-0/grey	
Dimension (DIN 43880)	4 TE	4 TE
Degree of protection (IEC EN 60529)	IP 20	IP 20
Power supply system	3 phase TNS systems	3 phase TT systems



### Combined arrester type 1 + 2 for AC power supplies / SumPro

#### SumPro BC

Single pole NPE lightning current arrester class I+II, based on isolating spark gap technology.

- No blow-out vents, thus, not requiring any safety clearance to other installations
- Discharge capacity up to 100 kA (10/350  $\mu$ s)
- High Insulation resistance
- EAC certification

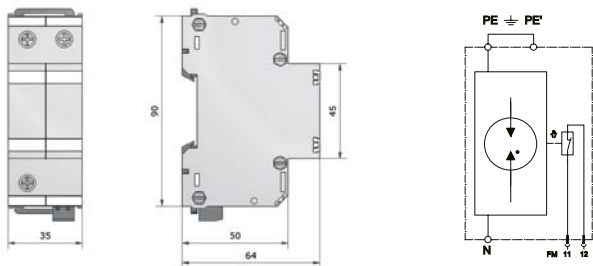

Technical Data	
<b>Product name</b>	<b>SP BC NPE 100/FM</b>
Article-No.	37 38 24
IEC category	Type 1 + 2 / class I+II
Nominal voltage AC	UN 230/400 V~
Max. continuous operating voltage AC (50/60Hz)	Uc 350 V~
Insulation resistance	Risol > 10 G $\Omega$
Protection level at 100% lightning impulse sparkover voltage (1.2/50 $\mu$ s)	Up $\leq$ 1.5 kV
Protection level	Up $\leq$ 1.5 kV
Response time	tA < 50 ns
Nominal discharge current (8/20 $\mu$ s) N-PE	In 100 kA
Lightning impulse current (10/350 $\mu$ s) L-N/N-PE/L-PEN limp	- / 100 / - kA
Short-circuit withstand capability at max. back-up fuse	I <sub>k</sub> 50 kA <sub>eff</sub>
Operating temperature range	TU -40 - +80°C
Max. conductor cross section	50mm <sup>2</sup> stranded/35mm <sup>2</sup> flexible
Recommended conductor cross section	25 mm <sup>2</sup>
Max. connection torque for terminals	4,0 Nm
Degree of protection (IEC EN 60529)	IP 20
Enclosure material / colour	polycarbonate UL 94-V0 / yellow
Mounting on	35 mm DIN rail (EN 60715)







## Devices for 40 mm busbar systems in the pre-counter section

### Surge protection with LT ZP ST T1+2+3/3+1-275

The new lightning current combined arresters type 1 + 2 + 3 of the LT ZP ST series for TT and TNS systems meet the requirements of lightning protection class III + IV in residential buildings.

The new LT ZP ST arresters can be snapped into place and fixed with a clip thanks to quick and easy installation on the 40 mm busbar system in the lower connection area of the meter space.

The LT ZP ST arresters offer the highest level of safety when making contact on the 40 mm busbar, with the option of simply disconnecting the highly reliable connection at any time.

The proven spark gap technology enables leakage-free use in the pre-meter area.

The arresters of the LT ZP ST series protect the entire electrical installation including the electronic meter.



## Wiring in 40 mm busbar systems

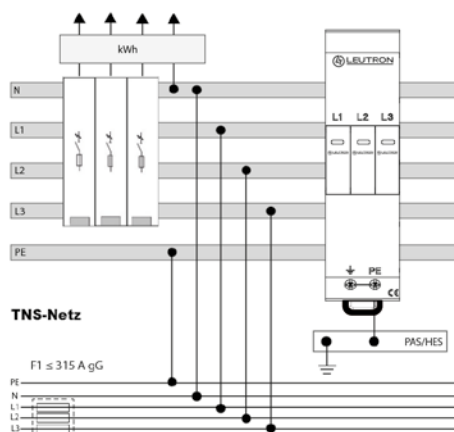
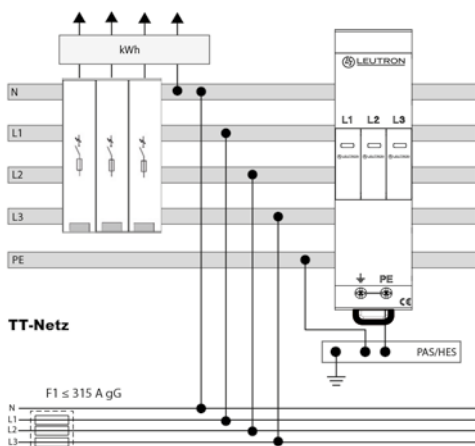



### SPD for 40 mm busbar systems in the pre-counter section

#### LT ZP ST T1+2+3/3+1

Four-pole, pluggable combined arrester for 3-phase TT and TNS systems (3 + 1 circuit). Location: main distribution board, 40 mm busbar systems. Can be used for lightning protection classes III and IV.



example image

- Test standard: IEC 61643-11 / EN 61643-11
- Combined Arresters Class I+II+III (T1+T2+T3)
- Surge arrester based on varistors (MOV) and GDT (Gas Discharge Tube)
- Leakage current free
- High lightning impulse discharge current of 12.5 kA (10/350 µs) per pole
- Visual function indicator
- Saves energy costs: does not generate any (net) follow-up current, operating and leakage-free

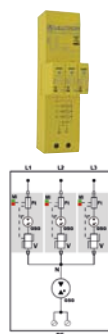
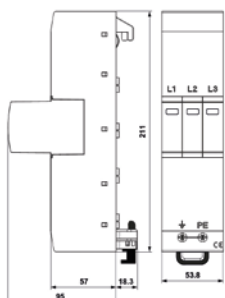

#### Technical Data

Product name	LT ZP ST T1+2+3/3+1-275-7.5kA	LT ZP ST T1+2+3/3+1-275-12.5kA
Article No.	38 16 82	38 16 81
IEC category	Type 1 + 2 + 3/ class I+II+III	Type 1 + 2 + 3/ class I+II+III
Nominal voltage AC	UN 230/400 V~	230/400 V~
Max. continuous operating voltage AC (50/60 Hz)	Uc 275 V~	275 V~
Nominal discharge current (8/20 µs) L-N/N-PE/L-PEN	In 20 / - / - kA	20 / - / - kA
Max. impulse discharge current (8/20) L-N/N-PE/L-PEN Imax	50 / - / - kA	50 / - / - kA
Lightning impulse current (10/350 µs) L-N/N-PE/L-PEN Iimp	7,5 / 30 / - kA	12,5 / 50 / - kA
Combined surge	Uoc 6 kV	6 kV
Protection level at In (8/20 µs) (L-N)	Up ≤ 1,25 kV	≤ 1,25 kV
Protection level L-PE at In (8/20 µs)	Up ≤ 1,5 kV	≤ 1,5 kV
Specific Energy	W/R 16 kJ/Ω	40 kJ/Ω
Short-circuit withstand capability at max. back-up fuse	Ik 50 kAeff	50 kAeff
Max. acceptable fuse or back-up fuse	315 A gG	315 A gG
TOV withstand 5s	UT 335 V	335 V
Temporary overvoltage rating 120 min	UT 440 V	440 V
Temporary overvoltage rating 200ms N-PE	UT 1200 V / 300 A / 200 ms	1200 V / 300 A / 200 ms
Operating temperature range	TU -40 - +85 °C	-40 - +85°C
Max. connection torque for terminals	3,5 - 4 (PZ-2) Nm	3,5 - 4 (PZ-2) Nm
Installation dimensions (H × W × D)	211 × 95 × 53,8 mm	211 × 95 × 53,8 mm
Max. conductor cross section	stranded 35/fine stranded 25 mm <sup>2</sup>	
Mounting	40mm busbar	
Degree of protection (IEC EN 60529)	IP 20	IP 20
Power supply system	3 phase TNS and TT systems	3 phase TNS and TT systems



## Connection boxes with SPD Type 1 in pre-counter section

### AK-T1

Connection boxes in the pre-counter section for the use in 3 phase TT, TNS and TNC systems according to DIN VDE 0100-443 und -534. Lightning current arrester based on gasfilled spark gaps. They provide extremely high discharge capabilities with at the same time very low protection levels and they also do not need any damageable internal or external electronic trigger. Place of installation is the pre-counter section in agreement of electrical power grid.

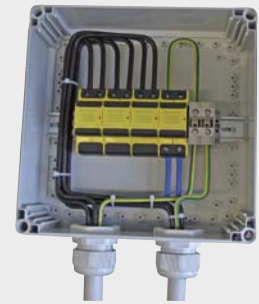

example image

- Applicable at the boundaries LPZ OA - 1
- Test standard: IEC 61643-11 / EN 61643-11
- Remote signalling contact: changeover contact
- Inflammability class according to UL 94 V0
- Leakage current free
- Optical status indication (red pin appears)
- Degree of protection according to IEC EN 60529: IP 66
- Single modules can be replaced easily
- Sealable

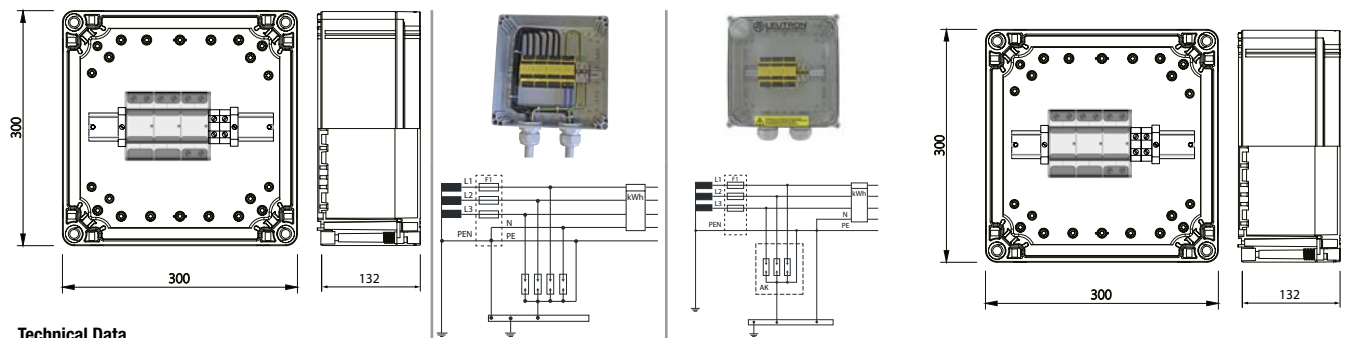

#### Technical Data

Product name	AK-T1/3+1-FM	AK-T1/3+0-FM
Articel No.	79 00 05	79 00 40
IEC category	Type 1 / class I	Type 1 / class I
Nominal voltage AC	UN 230/400 V~	230/400 V~
Max. continous operating voltage AC (50/60 Hz)	Uc 350 V~	350 V~
Lightning impulse current (10/350 µs) total	Itotal 100 kA	75 kA
Lightning impulse current (10/350 µs) L-N/N-PE/L-PEN	Iimp 25 / 100 / - kA	- / - / 25 kA
Nominal discharge current (8/20 µs) L-N/N-PE/L-PEN	In 25 / 100 / - kA	- / - / 25 kA
Protection level	Up ≤ 2,5 kV	≤ 2,5 kV
Follow-on current exti. capability AC L-N (260V AC)	Ifi 10 kAeff	10 kAeff
Follow-on current extinguishing capability AC N-PE	Ifi 100 Aeff	-
Short-circuit withstand capability at max. back-up fuse	Ik 50 kAeff	50 kAeff
Max. acceptable fuse or back-up fuse (serial wiring)	125 A gG	125 A gG
Operating temperature range	TU -40 - +80°C	-40 - +80 °C
Min. conductor cross section at terminals	10mm <sup>2</sup> solid/flexible	10mm <sup>2</sup> eindr./feindr.
Max. conductor cross section	50mm <sup>2</sup> stranded/35mm <sup>2</sup> flexible	50mm <sup>2</sup> mehrdr./35mm <sup>2</sup> feindr.
Max. conductor cross section FM	1,5 mm <sup>2</sup>	1,5 mm <sup>2</sup>
Max. connection torque for terminals	4,0 Nm	4,0 Nm
Max. locking torque FM terminals	0,25 Nm	0,25 Nm



### Connection boxes with SPD type 1 + 2 in pre-counter section

#### AK-T1+2

Connection boxes in the pre-counter section for the use in 3 phase TT, TNS or TNC systems according to DIN VDE 0100-443 und -534. Combined arrester based on rare gas filled spark gaps. Combined arrester with a very low protection level of < 1,5 kV. They provide extremely high discharge capabilities with at the same time very low protection levels and they also do not need any damageable internal or external electronic trigger. Place of installation is the pre-counter section in agreement of electrical power grid.

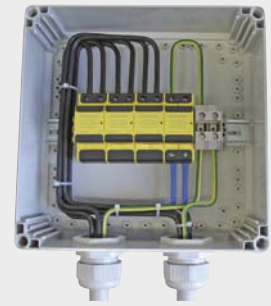

example image

- Applicable at the boundaries LPZ 0A - 2
- Test standard: IEC 61643-11 / EN 61643-11
- Inflammability class according to UL 94 V0
- Degree of protection according to IEC EN 60529: IP 66
- Remote signalling contact: changeover contact
- Leakage current free
- Single modules can be replaced easily
- Sealable
- Optical status indication (red pin appears)

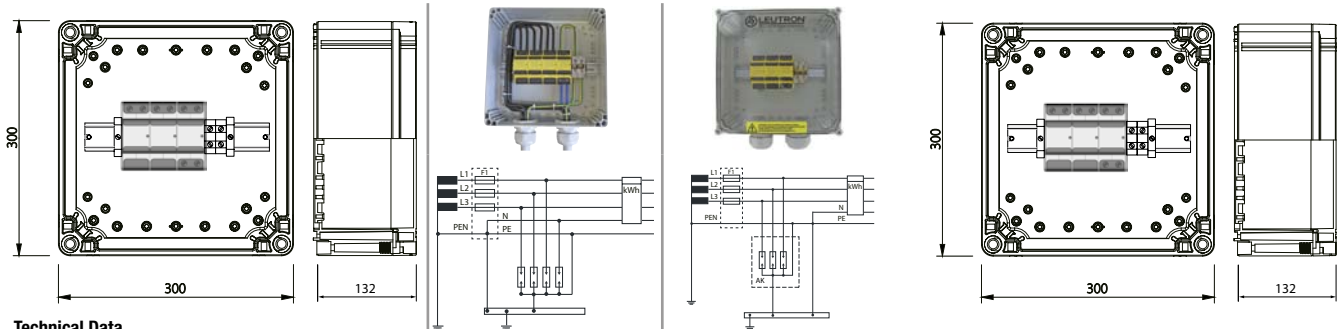

**Technical Data**

Product name	AK-T1+2/3+1-FM	AK-T1+2/3+0-FM
Articel No.	79 00 15	79 00 45
IEC category	Type 1 + 2 / class I+II	Type 1 + 2 / class I+II
Nominal voltage AC	UN 230/400 V~	230/400 V~
Max. continous operating voltage AC (50/60 Hz)	Uc 350 V~	350 V~
Lightning impulse current (10/350 µs) total	Itotal 100 kA	75 kA
Lightning impulse current (10/350 µs) L-N/N-PE/L-PEN	Iimp 25 / 100 / - kA	- / - / 25 kA
Nominal discharge current (8/20 µs) L-N/N-PE/L-PEN	In 25 / 100 / - kA	- / - / 25 kA
Protection level	Up ≤ 1,5 kV	≤ 1,5 kV
Follow-on current exti. capability AC L-N (260V AC)	I <sub>fi</sub> 4,0 kA <sub>eff</sub>	4,0 kA <sub>eff</sub>
Follow-on current extinguishing capability AC N-PE	I <sub>fi</sub> 100 A <sub>eff</sub>	-
Short-circuit withstand capability at max. back-up fuse	I <sub>k</sub> 50 kA <sub>eff</sub>	50 kA <sub>eff</sub>
Max. acceptable fuse or back-up fuse (serial wiring)	125 A gG	125 A gG
Operating temperature range	TU -40 - +80°C	-40 - +80 °C
Min. conductor cross section at terminals	10mm <sup>2</sup> solid/flexible	10mm <sup>2</sup> solid/flexible
Max. conductor cross section	50mm <sup>2</sup> stranded/35mm <sup>2</sup> flexible	50mm <sup>2</sup> stranded/35mm <sup>2</sup> flexible
Max. conductor cross section FM	1,5 mm <sup>2</sup>	1,5 mm <sup>2</sup>
Max. connection torque for terminals	4,0 Nm	4,0 Nm
Max. locking torque FM terminals	0,25 Nm	0,25 Nm



### Connection boxes wit SPD type 1 + 2 + 3 in pre-counter section

#### AK-T1+2+3

Connection boxes in the pre-counter section for the use in 3 phase TT, TNS or TNC systems according to DIN VDE 0100-443 und -534. Combined arrester based on rare gas filled spark gaps. Combined arrester with a very low protection level of < 1,0 kV. They provide extremely high discharge capabilities with at the same time very low protection levels and they also do not need any damageable internal or external electronic trigger. Place of installation is the pre-counter section in agreement of electrical power grid.

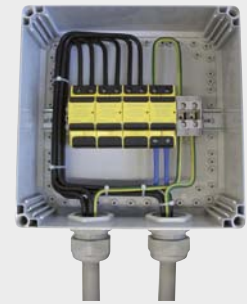

example image

- Applicable at the boundaries LPZ 0A - 2
- Test standard: IEC 61643-11 / EN 61643-11
- Degree of protection according to IEC EN 60529: IP 66
- Inflammability class according to UL 94 V0
- Remote signalling contact: changeover contact
- Leakage current free
- Single modules can be replaced easily
- Sealable
- Optical status indication (red pin appears)

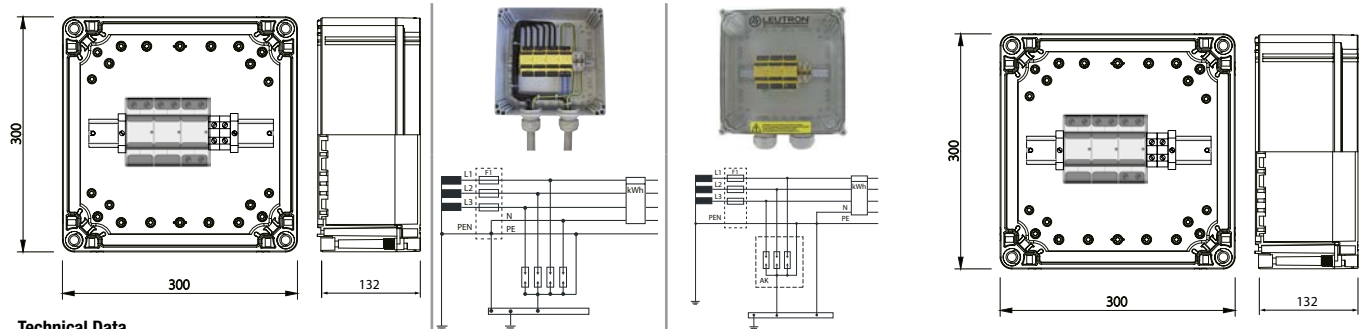

**Technical Data**

Product name	AK-T1+2+3/3+1-FM	AK-T1+2+3/3+0-FM
Articel No.	79 00 25	79 00 50
IEC category	Type 1 + 2 + 3 / class I+II+III	Type 1 + 2 + 3 / class I+II+III
Nominal voltage AC	UN 230/400 V~	230/400 V~
Max. continous operating voltage AC (50/60 Hz)	Uc 350 V~	350 V~
Lightning impulse current (10/350 µs) total	Itotal 100 kA	75 kA
Lightning impulse current (10/350 µs) L-N/N-PE/L-PEN	Iimp 25 / 100 / - kA	- / - / 25 kA
Nominal discharge current (8/20 µs) L-N/N-PE/L-PEN	In 25 / 100 / - kA	- / - / 25 kA
Protection level	Up ≤ 1,0 kV	≤ 1,0 kV
Follow-on current ext. capability AC L-N (260V AC)	I <sub>fi</sub> 4,0 kAeff	4,0 kAeff
Follow-on current extinguishing capability AC N-PE	I <sub>fi</sub> 100 Aeff	-
Short-circuit withstand capability at max. back-up fuse	I <sub>k</sub> 50 kAeff	50 kAeff
Max. acceptable fuse or back-up fuse (serial wiring)	125 A gG	125 A gG
Operating temperature range	TU -40 - +80 °C	-40 - +80 °C
Min. conductor cross section at terminals	10mm <sup>2</sup> solid/flexible	10mm <sup>2</sup> solid/flexible
Max. conductor cross section	50mm <sup>2</sup> stranded/35mm <sup>2</sup> flexible	50mm <sup>2</sup> stranded/35mm <sup>2</sup> flexible
Max. conductor cross section FM	1,5 mm <sup>2</sup>	1,5 mm <sup>2</sup>
Max. connection torque for terminals	4,0 Nm	4,0 Nm
Max. locking torque FM terminals	0,25 Nm	0,25 Nm



### SPD type 2 for AC power supplies / EL series

#### EL-T2

Fully pluggable surge protective arrester type 2 (class II) for the use in 1, 2 and 3 phase power supply systems. Prewired complete unit consisting of base part and modules. Variants available of 75 up to 750 Volt .



example image

- Test standard: IEC 61643-11 / EN 61643-11
- Vibration test standard: DIN EN 60068-2-6, IEC 60068-2-6
- Shock test standard: DIN EN 60068-2-27, IEC 60068-2-27
- Mounting on 35 mm DIN rail (EN 60715)
- Inflammability class according to UL 97 V0
- EAC certification
- Remote signalling contact (FM): changeover contact
- Max. operating voltage remote contact: 250 V AC/125 V DC
- Max. operating current remote contact: 1 A AC/200 mA DC
- Max. conductor cross section FM: 1,5 mm<sup>2</sup>

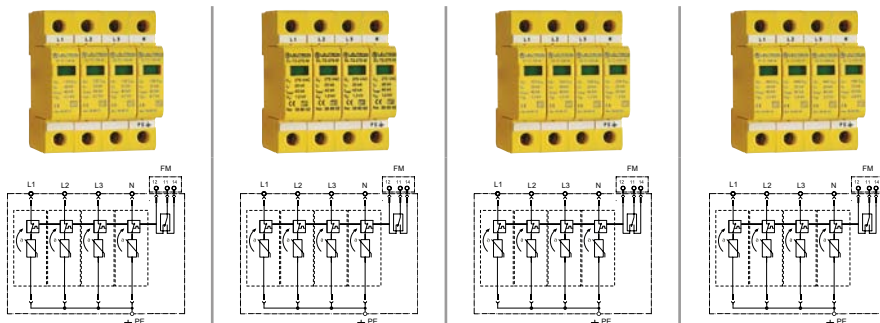

#### Technical Data

Product name	EL-T2/4+0-130-FM	EL-T2/4+0-275-FM	EL-T2/4+0-350-FM	EL-T2/4+0-440-FM
Article-No.	38 81 01	38 81 02	38 81 03	38 81 04
IEC category	Type 2 / class II	Type 2 / class II	Type 2 / class II	Type 2 / class II
Nominal voltage AC	UN 120 V~	230 V~	230 V~	230 V~
Max. continuous operating voltage AC (50/60Hz)	Uc 130 V~	275 V~	350 V~	440 V~
Nominal discharge current (8/20 μs)	In 20 kA	20 kA	20 kA	20 kA
Max. impulse discharge current (8/20 μs)	I <sub>max</sub> 40 kA	40 kA	40 kA	40 kA
Protection level at In	Up ≤ 0,7 kV	≤ 1,2 kV	≤ 1,5 kV	≤ 2,0 kV
Protection level at 5 kA	Up ≤ 0,5 kV	≤ 0,9 kV	≤ 1,0 kV	≤ 1,5 kV
Short-circuit withstand capability at max. back-up fuse	I <sub>k</sub> 25 kAeff	25 kAeff	25 kAeff	25 kAeff
Max. acceptable fuse or back-up fuse	125 A gG	125 A gG	125 A gG	125 A gG
Operating temperature range	TU -40 - +80 °C	-40 - +80 °C	-40 - +80 °C	-40 - +80 °C
Min. conductor cross section at terminals	1.5mm <sup>2</sup> solid/flexible	1.5mm <sup>2</sup> solid/flexible	1.5mm <sup>2</sup> solid/flexible	1.5mm <sup>2</sup> solid/flexible
Max. conductor cross section	35mm <sup>2</sup> stranded/25mm <sup>2</sup> flexible	35mm <sup>2</sup> stranded/25mm <sup>2</sup> flexible	35mm <sup>2</sup> stranded/25mm <sup>2</sup> flexible	35mm <sup>2</sup> stranded/25mm <sup>2</sup> flexible
Max. connection torque for terminals	3,5 Nm	3,5 Nm	3,5 Nm	3,5 Nm
Enclosure material / colour	Thermoplastic, yellow, UL 97 V-0	Thermoplastic, yellow, UL 97 V-0	Thermoplastic, yellow, UL 97 V-0	Thermoplastic, yellow, UL 97 V-0
Degree of protection (IEC EN 60529)	IP 20	IP 20	IP 20	IP 20
Dimension (DIN 43880)	4 TE	4 TE	4 TE	4 TE
Power supply system	3 phase TNS systems	3 phase TNS systems	3 phase TNS systems	3 phase TNS systems
Composed of: number of moduls	4x 38 80 01	4x 38 80 02	4x 38 80 03	4x 38 80 04



## SPD type 2 for AC power supplies / EL series

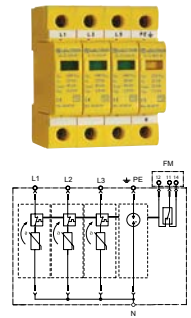
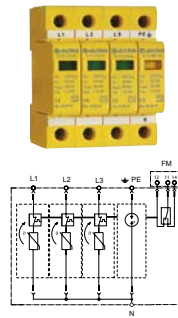
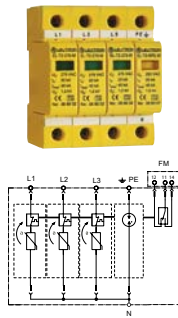
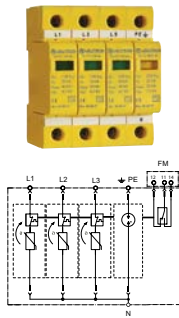

### Technical Data

Product name	EL-T2/3+1-130-FM	EL-T2/3+1-275-FM	EL-T2/3+1-350-FM	EL-T2/3+1-440-FM
Article-No.	38 81 15	38 81 16	38 81 17	38 81 18
IEC category	Type 2 / class II	Type 2 / class II	Type 2 / class II	Type 2 / class II
Nominal voltage AC	UN 120 V~	230 V~	230 V~	230 V~
Max. continuous operating voltage AC (50/60Hz)	Uc 130 V~	275 V~	350 V~	440 V~
Nominal discharge current (8/20 μs)	In 20 kA	20 kA	20 kA	20 kA
Max. impulse discharge current (8/20 μs)	I <sub>max</sub> 40 kA	40 kA	40 kA	40 kA
Protection level at In	Up ≤ 0,7 kV	≤ 1,2 kV	≤ 1,5 kV	≤ 2,0 kV
Protection level at 5 kA	Up ≤ 0,5 kV	≤ 0,9 kV	≤ 1,0 kV	≤ 1,5 kV
Protection level N-PE	Up ≤ 1,5 kV	≤ 1,5 kV	≤ 1,5 kV	≤ 1,5 kV
Follow-on current extinguishing capability AC N-PE	I <sub>fi</sub> 100 Aeff	100 Aeff	100 Aeff	100 Aeff
Short-circuit withstand capability at max. back-up fuse	I <sub>k</sub> 25 kAeff	25 kAeff	25 kAeff	25 kAeff
Max. acceptable fuse or back-up fuse	125 A gG	125 A gG	125 A gG	125 A gG
Operating temperature range	TU -40 - +80 °C	-40 - +80 °C	-40 - +80 °C	-40 - +80 °C
Min. conductor cross section at terminals	1.5mm <sup>2</sup> solid/flexible	1.5mm <sup>2</sup> solid/flexible	1.5mm <sup>2</sup> solid/flexible	1.5mm <sup>2</sup> solid/flexible
Max. conductor cross section	35mm <sup>2</sup> stranded/25mm <sup>2</sup> flexible	35mm <sup>2</sup> stranded/25mm <sup>2</sup> flexible	35mm <sup>2</sup> stranded/25mm <sup>2</sup> flexible	35mm <sup>2</sup> stranded/25mm <sup>2</sup> flexible
Max. connection torque for terminals	3,5 Nm	3,5 Nm	3,5 Nm	3,5 Nm
Enclosure material / colour	Thermoplastic, yellow, UL 97 V-0	Thermoplastic, yellow, UL 97 V-0	Thermoplastic, yellow, UL 97 V-0	Thermoplastic, yellow, UL 97 V-0
Degree of protection (IEC EN 60529)	IP 20	IP 20	IP 20	IP 20
Power supply system	3 phase TT systems	3 phase TT systems	3 phase TT systems	3 phase TT systems
Max. operating voltage remote contact FM	250 V AC/125 V DC	250 V AC/125 V DC	250 V AC/125 V DC	250 V AC/125 V DC
Max. operating current remote contact FM	1 A AC/200 mA DC	1 A AC/200 mA DC	1 A AC/200 mA DC	1 A AC/200 mA DC
Max. conductor cross section FM	1,5 mm <sup>2</sup>	1,5 mm <sup>2</sup>	1,5 mm <sup>2</sup>	1,5 mm <sup>2</sup>
Composed of: number of moduls	3x 38 80 01 + 1x 38 80 07	3x 38 80 02 + 1x 38 80 07	3x 38 80 03 + 1x 38 80 07	3x 38 80 04 + 1x 38 80 07

### Dimension

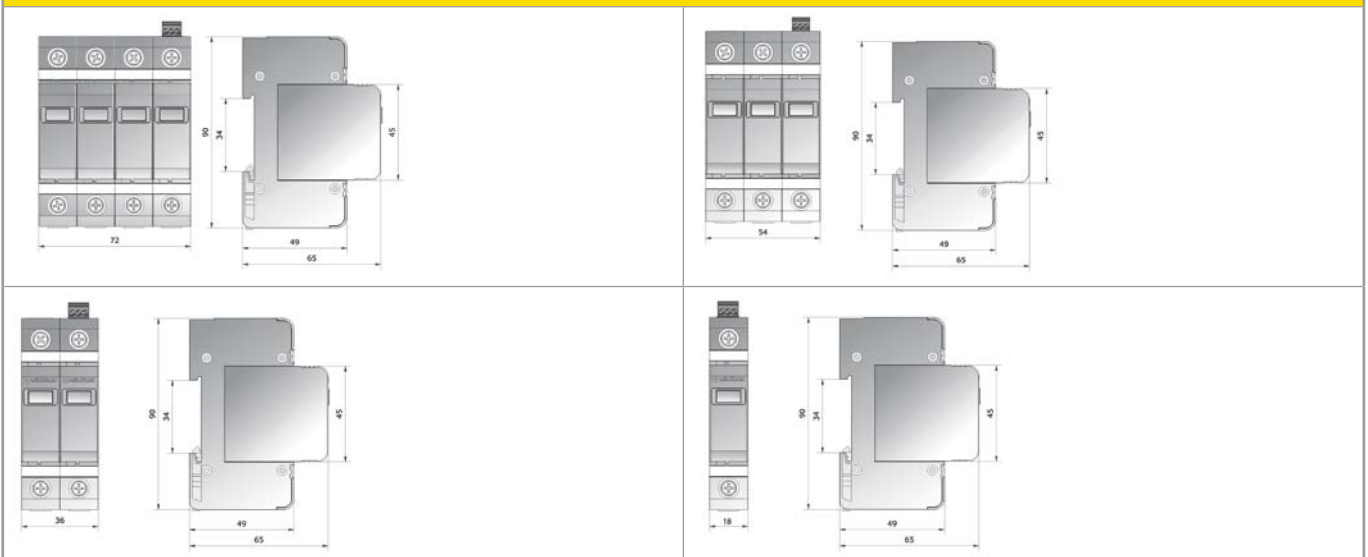



### SPD type 2 for AC power supplies / EL series

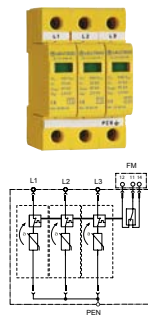
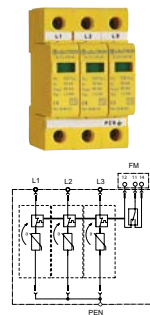
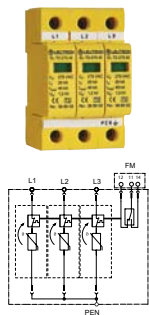
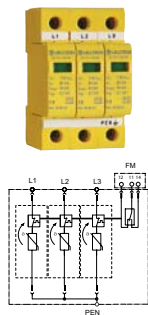

#### Technical Data

Product name	EL-T2/3+0-130-FM	EL-T2/3+0-275-FM	EL-T2/3+0-350-FM	EL-T2/3+0-440-FM
Article-No.	38 81 29	38 81 30	38 81 31	38 81 32
IEC category	Type 2 / class II	Type 2 / class II	Type 2 / class II	Type 2 / class II
Nominal voltage AC	UN 120 V~	230 V~	230 V~	230 V~
Max. continuous operating voltage AC (50/60Hz)	Uc 130 V~	275 V~	350 V~	440 V~
Nominal discharge current (8/20 μs)	In 20 kA	20 kA	20 kA	20 kA
Max. impulse discharge current (8/20 μs)	Imax 40 kA	40 kA	40 kA	40 kA
Protection level at In	Up ≤ 0,7 kV	≤ 1,2 kV	≤ 1,5 kV	≤ 2,0 kV
Protection level at 5 kA	Up ≤ 0,5 kV	≤ 0,9 kV	≤ 1,0 kV	≤ 1,5 kV
Short-circuit withstand capability at max. back-up fuse	Ik 25 kAeff	25 kAeff	25 kAeff	25 kAeff
Max. acceptable fuse or back-up fuse	125 A gG	125 A gG	125 A gG	125 A gG
Operating temperature range	TU -40 - +80 °C	-40 - +80 °C	-40 - +80 °C	-40 - +80 °C
Min. conductor cross section at terminals	1.5mm <sup>2</sup> solid/flexible	1.5mm <sup>2</sup> solid/flexible	1.5mm <sup>2</sup> solid/flexible	1.5mm <sup>2</sup> solid/flexible
Max. conductor cross section	35mm <sup>2</sup> stranded/25mm <sup>2</sup> flexible	35mm <sup>2</sup> stranded/25mm <sup>2</sup> flexible	35mm <sup>2</sup> stranded/25mm <sup>2</sup> flexible	35mm <sup>2</sup> stranded/25mm <sup>2</sup> flexible
Max. connection torque for terminals	3,5 Nm	3,5 Nm	3,5 Nm	3,5 Nm
Enclosure material / colour	Thermoplastic, yellow, UL 97 V-0	Thermoplastic, yellow, UL 97 V-0	Thermoplastic, yellow, UL 97 V-0	Thermoplastic, yellow, UL 97 V-0
Degree of protection (IEC EN 60529)	IP 20	IP 20	IP 20	IP 20
Dimension (DIN 43880)	3 TE	3 TE	3 TE	3 TE
Power supply system	3 phase TNC systems	3 phase TNC systems	3 phase TNC systems	3 phase TNC systems
Max. operating voltage remote contact FM	250 V AC/125 V DC	250 V AC/125 V DC	250 V AC/125 V DC	250 V AC/125 V DC
Max. operating current remote contact FM	1 A AC/200 mA DC	1 A AC/200 mA DC	1 A AC/200 mA DC	1 A AC/200 mA DC
Max. conductor cross section FM	1,5 mm <sup>2</sup>	1,5 mm <sup>2</sup>	1,5 mm <sup>2</sup>	1,5 mm <sup>2</sup>
Composed of: number of moduls	3x 38 80 01	3x 38 80 02	3x 38 80 03	3x 38 80 04





### SPD type 2 for AC power supplies / EL series

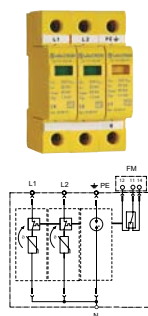
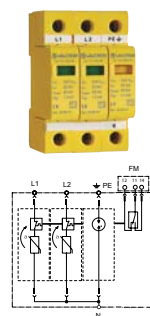
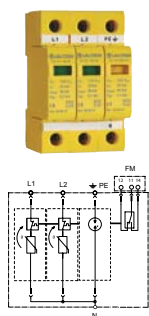
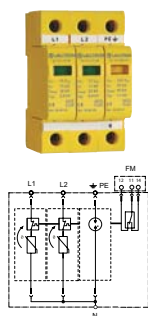

#### Technical Data

Product name	EL-T2/2+1-75-FM	EL-T2/2+1-130-FM	EL-T2/2+1-275-FM	EL-T2/2+1-350-FM
Article-No.	38 81 42	38 81 43	38 81 44	38 81 45
IEC category	Type 2 / class II	Type 2 / class II	Type 2 / class II	Type 2 / class II
Nominal voltage AC	UN 60 V~	120 V~	230 V~	230 V~
Max. continuous operating voltage AC (50/60Hz)	Uc 75 V~	130 V~	275 V~	350 V~
Nominal discharge current (8/20 μs)	In 15 kA	20 kA	20 kA	20 kA
Max. impulse discharge current (8/20 μs)	Imax 30 kA	40 kA	40 kA	40 kA
Protection level at In	Up ≤ 0,4 kV	≤ 0,7 kV	≤ 1,2 kV	≤ 1,5 kV
Protection level at 5 kA	Up ≤ 0,33 kV	≤ 0,5 kV	≤ 0,9 kV	≤ 1,0 kV
Protection level N-PE	Up ≤ 1,5 kV	≤ 1,5 kV	≤ 1,5 kV	≤ 1,5 kV
Short-circuit withstand capability at max. back-up fuse	Ik 25 kAeff	25 kAeff	25 kAeff	25 kAeff
Max. acceptable fuse or back-up fuse	125 A gG	125 A gG	125 A gG	125 A gG
Operating temperature range	TU -40 - +80 °C	-40 - +80 °C	-40 - +80 °C	-40 - +80 °C
Min. conductor cross section at terminals	1.5mm <sup>2</sup> solid/flexible	1.5mm <sup>2</sup> solid/flexible	1.5mm <sup>2</sup> solid/flexible	1.5mm <sup>2</sup> solid/flexible
Max. conductor cross section	35mm <sup>2</sup> stranded/25mm <sup>2</sup> flexible	35mm <sup>2</sup> stranded/25mm <sup>2</sup> flexible	35mm <sup>2</sup> stranded/25mm <sup>2</sup> flexible	35mm <sup>2</sup> stranded/25mm <sup>2</sup> flexible
Enclosure material / colour	Thermoplastic, yellow, UL 97 V-0	Thermoplastic, yellow, UL 97 V-0	Thermoplastic, yellow, UL 97 V-0	Thermoplastic, yellow, UL 97 V-0
Degree of protection (IEC EN 60529)	IP 20	IP 20	IP 20	IP 20
Dimension (DIN 43880)	3 TE	3 TE	3 TE	3 TE
Max. connection torque for terminals	3,5 Nm	3,5 Nm	3,5 Nm	3,5 Nm
Power supply system	2 phase TT systems	2 phase TT systems	2 phase TT systems	2 phase TT systems
Max. operating voltage remote contact FM	250 V AC/125 V DC	250 V AC/125 V DC	250 V AC/125 V DC	250 V AC/125 V DC
Max. operating current remote contact FM	1 A AC/200 mA DC	1 A AC/200 mA DC	1 A AC/200 mA DC	1 A AC/200 mA DC
Max. conductor cross section FM	1,5 mm <sup>2</sup>	1,5 mm <sup>2</sup>	1,5 mm <sup>2</sup>	1,5 mm <sup>2</sup>
Composed of: number of moduls	2x 38 80 00 + 1x 38 80 07	2x 38 80 01 + 1x 38 80 07	2x 38 80 02 + 1x 38 80 07	2x 38 80 03 + 1x 38 80 07



### SPD type 2 for AC power supplies / EL series

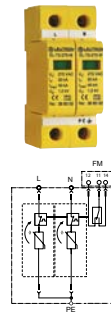
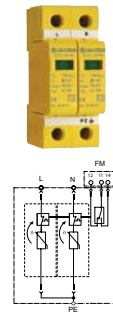
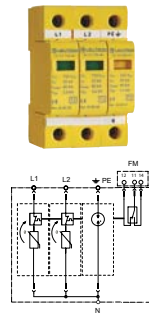
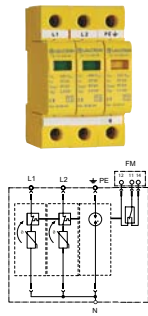

#### Technical Data

Product name	EL-T2/2+1-440-FM	EL-T2/2+1-550-FM	EL-T2/2+0-130-FM	EL-T2/2+0-275-FM
Article-No.	38 81 46	38 81 47	38 81 57	38 81 58
IEC category	Type 2 / class II	Type 2 / class II	Type 2 / class II	Type 2 / class II
Nominal voltage AC	UN 230 V~	400 V~	120 V~	230 V~
Max. continuous operating voltage AC (50/60Hz)	Uc 440 V~	550 V~	130 V~	275 V~
Nominal discharge current (8/20 μs)	In 20 kA	20 kA	20 kA	20 kA
Max. impulse discharge current (8/20 μs)	Imax 40 kA	40 kA	40 kA	40 kA
Protection level at In	Up ≤ 2,0 kV	≤ 2,5 kV	≤ 0,7 kV	≤ 1,2 kV
Protection level at 5 kA	Up ≤ 1,5 kV	≤ 1,8 kV	≤ 0,5 kV	≤ 0,9 kV
Protection level N-PE	Up ≤ 1,5 kV	≤ 1,5 kV	-	-
Short-circuit withstand capability at max. back-up fuse	I <sub>k</sub> 25 kAeff	25 kAeff	25 kAeff	25 kAeff
Max. acceptable fuse or back-up fuse	125 A gG	125 A gG	125 A gG	125 A gG
Operating temperature range	TU -40 - +80 °C	-40 - +80 °C	-40 - +80 °C	-40 - +80 °C
Min. conductor cross section at terminals	1.5mm <sup>2</sup> solid/flexible	1.5mm <sup>2</sup> solid/flexible	1.5mm <sup>2</sup> solid/flexible	1.5mm <sup>2</sup> solid/flexible
Max. conductor cross section	35mm <sup>2</sup> stranded/25mm <sup>2</sup> flexible	35mm <sup>2</sup> stranded/25mm <sup>2</sup> flexible	35mm <sup>2</sup> stranded/25mm <sup>2</sup> flexible	35mm <sup>2</sup> stranded/25mm <sup>2</sup> flexible
Enclosure material / colour	Thermoplastic, yellow, UL 97 V-0	Thermoplastic, yellow, UL 97 V-0	Thermoplastic, yellow, UL 97 V-0	Thermoplastic, yellow, UL 97 V-0
Degree of protection (IEC EN 60529)	IP 20	IP 20	IP 20	IP 20
Dimension (DIN 43880)	3 TE	3 TE	3 TE	3 TE
Max. connection torque for terminals	3,5 Nm	3,5 Nm	3,5 Nm	3,5 Nm
Power supply system	2 phase TT systems	2 phase TT systems	1 phase TN systems	1 phase TN systems
Max. operating voltage remote contact FM	250 V AC/125 V DC	250 V AC/125 V DC	250 V AC/125 V DC	250 V AC/125 V DC
Max. operating current remote contact FM	1 A AC/200 mA DC	1 A AC/200 mA DC	1 A AC/200 mA DC	1 A AC/200 mA DC
Max. conductor cross section FM	1,5 mm <sup>2</sup>	1,5 mm <sup>2</sup>	1,5 mm <sup>2</sup>	1,5 mm <sup>2</sup>
Composed of: number of moduls	2x 38 80 04 + 1x 38 80 07	2x 38 80 05 + 1x 38 80 07	2x 38 80 01	2x 38 80 02



### SPD type 2 for AC power supplies / EL series

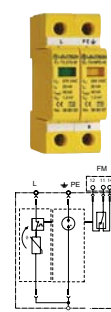
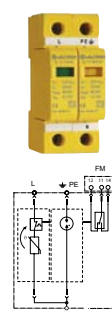
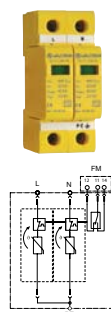
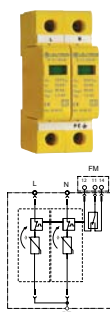

#### Technical Data

Product name	EL-T2/2+0-350-FM	EL-T2/2+0-440-FM	EL-T2/1+1-130-FM	EL-T2/1+1-275-FM
Article-No.	38 81 59	38 81 60	38 81 71	38 81 72
IEC category	Type 2 / class II	Type 2 / class II	Type 2 / class II	Type 2 / class II
Nominal voltage AC	UN 230 V~	230 V~	120 V~	230 V~
Max. continuous operating voltage AC (50/60Hz)	Uc 350 V~	440 V~	130 V~	275 V~
Nominal discharge current (8/20 μs)	In 20 kA	20 kA	20 kA	20 kA
Max. impulse discharge current (8/20 μs)	I <sub>max</sub> 40 kA	40 kA	40 kA	40 kA
Protection level at In	U <sub>p</sub> ≤ 1,5 kV	≤ 2,0 kV	≤ 0,7 kV	≤ 1,2 kV
Protection level at 5 kA	U <sub>p</sub> ≤ 1,0 kV	≤ 1,5 kV	≤ 0,5 kV	≤ 0,9 kV
Short-circuit withstand capability at max. back-up fuse	I <sub>lk</sub> 25 kA <sub>eff</sub>	25 kA <sub>eff</sub>	25 kA <sub>eff</sub>	25 kA <sub>eff</sub>
Max. acceptable fuse or back-up fuse	125 A gG	125 A gG	125 A gG	125 A gG
Operating temperature range	TU -40 - +80 °C	-40 - +80 °C	-40 - +80 °C	-40 - +80 °C
Min. conductor cross section at terminals	1.5mm <sup>2</sup> solid/flexible	1.5mm <sup>2</sup> solid/flexible	1.5mm <sup>2</sup> solid/flexible	1.5mm <sup>2</sup> solid/flexible
Max. conductor cross section	35mm <sup>2</sup> stranded/25mm <sup>2</sup> flexible	35mm <sup>2</sup> stranded/25mm <sup>2</sup> flexible	35mm <sup>2</sup> stranded/25mm <sup>2</sup> flexible	35mm <sup>2</sup> stranded/25mm <sup>2</sup> flexible
Enclosure material / colour	Thermoplastic, yellow, UL 97 V-0	Thermoplastic, yellow, UL 97 V-0	Thermoplastic, yellow, UL 97 V-0	Thermoplastic, yellow, UL 97 V-0
Degree of protection (IEC EN 60529)	IP 20	IP 20	IP 20	IP 20
Dimension (DIN 43880)	2 TE	2 TE	2 TE	2 TE
Max. connection torque for terminals	3,5 Nm	3,5 Nm	3,5 Nm	3,5 Nm
Power supply system	1 phase TN systems	1 phase TN systems	1 phase TT and TNS systems	1 phase TT and TNS systems
Max. operating voltage remote contact FM	250 V AC/125 V DC	250 V AC/125 V DC	250 V AC/125 V DC	250 V AC/125 V DC
Max. operating current remote contact FM	1 A AC/200 mA DC	1 A AC/200 mA DC	1 A AC/200 mA DC	1 A AC/200 mA DC
Max. conductor cross section FM	1,5 mm <sup>2</sup>	1,5 mm <sup>2</sup>	1,5 mm <sup>2</sup>	1,5 mm <sup>2</sup>
Composed of: number of moduls	2x 38 80 03	2x 38 80 04	1x 38 80 01 + 1x 38 80 07	1x 38 80 02 + 1x 38 80 07



### SPD type 2 for AC power supplies / EL series

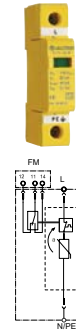
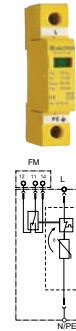
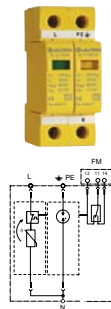
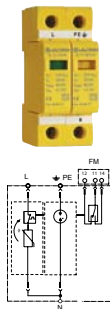

#### Technical Data

Product name	EL-T2/1+1-350-FM	EL-T2/1+1-440-FM	EL-T2/1+0-75-FM	EL-T2/1+0-130-FM
Article-No.	38 81 73	38 81 74	38 81 84	38 81 85
IEC category	Type 2 / class II	Type 2 / class II	Type 2 / class II	Type 2 / class II
Nominal voltage AC	UN 230 V~	230 V~	60 V~	120 V~
Max. continuous operating voltage AC (50/60Hz)	Uc 350 V~	440 V~	75 V~	130 V~
Nominal discharge current (8/20 μs)	In 20 kA	20 kA	15 kA	20 kA
Max. impulse discharge current (8/20 μs)	Imax 40 kA	40 kA	30 kA	40 kA
Protection level at In	Up ≤ 1,5 kV	≤ 2,0 kV	≤ 0,4 kV	≤ 0,7 kV
Protection level at 5 kA	Up ≤ 1,0 kV	≤ 1,5 kV	≤ 0,33 kV	≤ 0,5 kV
Protection level N-PE	Up ≤ 1,5 kV	≤ 1,5 kV	-	-
Follow-on current extinguishing capability AC N-PE	I <sub>fi</sub> 100 Aeff	100 Aeff	-	-
Short-circuit withstand capability at max. back-up fuse	I <sub>k</sub> 25 kAeff	25 kAeff	25 kAeff	25 kAeff
Max. acceptable fuse or back-up fuse	125 A gG	125 A gG	125 A gG	125 A gG
Operating temperature range	TU -40 - +80 °C	-40 - +80 °C	-40 - +80 °C	-40 - +80 °C
Min. conductor cross section at terminals	1.5mm <sup>2</sup> solid/flexible	1.5mm <sup>2</sup> solid/flexible	1.5mm <sup>2</sup> solid/flexible	1.5mm <sup>2</sup> solid/flexible
Max. conductor cross section	35mm <sup>2</sup> stranded/25mm <sup>2</sup> flexible	35mm <sup>2</sup> stranded/25mm <sup>2</sup> flexible	35mm <sup>2</sup> stranded/25mm <sup>2</sup> flexible	35mm <sup>2</sup> stranded/25mm <sup>2</sup> flexible
Enclosure material / colour	Thermoplastic, yellow, UL 97 V-0	Thermoplastic, yellow, UL 97 V-0	Thermoplastic, yellow, UL 97 V-0	Thermoplastic, yellow, UL 97 V-0
Degree of protection (IEC EN 60529)	IP 20	IP 20	IP 20	IP 20
Dimension (DIN 43880)	2 TE	2 TE	1 TE	1 TE
Power supply system	1 phase TT and TNS systems	1 phase TT and TNS systems	between L and N	between L and N
Max. operating voltage remote contact FM	250 V AC/125 V DC	250 V AC/125 V DC	250 V AC/125 V DC	250 V AC/125 V DC
Max. operating current remote contact FM	1 A AC/200 mA DC	1 A AC/200 mA DC	1 A AC/200 mA DC	1 A AC/200 mA DC
Max. conductor cross section FM	1,5 mm <sup>2</sup>	1,5 mm <sup>2</sup>	1,5 mm <sup>2</sup>	1,5 mm <sup>2</sup>
Composed of: number of moduls	1x 38 80 03 + 1x 38 80 07	1x 38 80 04 + 1x 38 80 07	1x 38 80 00	1x 38 80 01



### SPD type 2 for AC power supplies / EL series

Technical Data	EL-T2/1+0-275-FM	EL-T2/1+0-350-FM	EL-T2/1+0-440-FM	EL-T2/1+0-550-FM
Product name	EL-T2/1+0-275-FM	EL-T2/1+0-350-FM	EL-T2/1+0-440-FM	EL-T2/1+0-550-FM
Article-No.	38 81 86	38 81 87	38 81 88	38 81 89
IEC category	Type 2 / class II	Type 2 / class II	Type 2 / class II	Type 2 / class II
Nominal voltage AC	UN 230 V~	230 V~	230 V~	400 V~
Max. continuous operating voltage AC (50/60Hz)	Uc 275 V~	350 V~	440 V~	550 V~
Nominal discharge current (8/20 μs)	In 20 kA	20 kA	20 kA	20 kA
Max. impulse discharge current (8/20 μs)	Imax 40 kA	40 kA	40 kA	40 kA
Protection level at In	Up ≤ 1,2 kV	≤ 1,5 kV	≤ 2,0 kV	≤ 2,5 kV
Protection level at 5 kA	Up ≤ 0,9 kV	≤ 1,0 kV	≤ 1,5 kV	≤ 1,8 kV
Short-circuit withstand capability at max. back-up fuse	I <sub>lk</sub> 25 kAeff	25 kAeff	25 kAeff	25 kAeff
Max. acceptable fuse or back-up fuse	125 A gG	125 A gG	125 A gG	125 A gG
Operating temperature range	TU -40 - +80 °C	-40 - +80 °C	-40 - +80 °C	-40 - +80 °C
Min. conductor cross section at terminals	1.5mm <sup>2</sup> solid/flexible	1.5mm <sup>2</sup> solid/flexible	1.5mm <sup>2</sup> solid/flexible	1.5mm <sup>2</sup> solid/flexible
Max. conductor cross section	35mm <sup>2</sup> stranded/25mm <sup>2</sup> flexible	35mm <sup>2</sup> stranded/25mm <sup>2</sup> flexible	35mm <sup>2</sup> stranded/25mm <sup>2</sup> flexible	35mm <sup>2</sup> stranded/25mm <sup>2</sup> flexible
Enclosure material / colour	Thermoplastic, yellow, UL 97 V-0	Thermoplastic, yellow, UL 97 V-0	Thermoplastic, yellow, UL 97 V-0	Thermoplastic, yellow, UL 97 V-0
Degree of protection (IEC EN 60529)	IP 20	IP 20	IP 20	IP 20
Dimension (DIN 43880)	1 TE	1 TE	1 TE	1 TE
Max. connection torque for terminals	3,5 Nm	3,5 Nm	3,5 Nm	3,5 Nm
Power supply system	between L and N	between L and N	between L and N	between L and N
Max. operating voltage remote contact FM	250 V AC/125 V DC	250 V AC/125 V DC	250 V AC/125 V DC	250 V AC/125 V DC
Max. operating current remote contact FM	1 A AC/200 mA DC	1 A AC/200 mA DC	1 A AC/200 mA DC	1 A AC/200 mA DC
Max. conductor cross section FM	1,5 mm <sup>2</sup>	1,5 mm <sup>2</sup>	1,5 mm <sup>2</sup>	1,5 mm <sup>2</sup>
Composed of: number of moduls	1x 38 80 02	1x 38 80 03	1x 38 80 04	1x 38 80 05



### SPD type 2 for AC power supplies / EL series

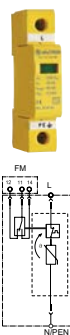

#### Technical Data

Product name	EL-T2/1+0-750-FM
Article-No.	38 81 90
IEC category	Type 2 / class II
Nominal voltage AC	UN 400 V~
Max. continuous operating voltage AC (50/60Hz)	Uc 750 V~
Nominal discharge current (8/20 μs)	In 20 kA
Max. impulse discharge current (8/20 μs)	Imax 40 kA
Protection level at In	Up ≤ 3,0 kV
Protection level at 5 kA	Up ≤ 2,5 kV
Short-circuit withstand capability at max. back-up fuse	Ik 25 kAeff
Max. acceptable fuse or back-up fuse	125 A gG
Operating temperature range	TU -40 - +80 °C
Min. conductor cross section at terminals	1.5mm <sup>2</sup> solid/flexible
Max. conductor cross section	35mm <sup>2</sup> stranded/25mm <sup>2</sup> flexible
Enclosure material / colour	Thermoplastic, yellow, UL 97 V-0
Degree of protection (IEC EN 60529)	IP 20
Dimension (DIN 43880)	1 TE
Max. connection torque for terminals	3,5 Nm
Power supply system	between L and N
Max. operating voltage remote contact FM	250 V AC/125 V DC
Max. operating current remote contact FM	1 A AC/200 mA DC
Max. conductor cross section FM	1,5 mm <sup>2</sup>
Composed of: number of moduls	1x 38 80 06

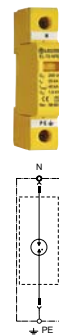

#### Technical Data

Product name	EL-T2/0+1-NPE
Article-No.	38 81 98
IEC category	Type 2 / class II
Nominal voltage AC	UN 230 V~
Max. continuous operating voltage AC (50/60Hz)	Uc 260 V~
Nominal discharge current (8/20 μs)	In 20 kA
Max. impulse discharge current (8/20 μs)	Imax 40 kA
Protection level N-PE	Up ≤ 1,5 kV
Follow-on current extinguishing capability AC N-PE	Ifi 100 Aeff
Short-circuit withstand capability at max. back-up fuse	Ik 25 kAeff
Max. acceptable fuse or back-up fuse	125 A gG
Operating temperature range	TU -40 - +80 °C
Min. conductor cross section at terminals	1.5mm <sup>2</sup> solid/flexible
Max. conductor cross section	35mm <sup>2</sup> stranded/25mm <sup>2</sup> flexible
Enclosure material / colour	Thermoplastic, yellow, UL 97 V-0
Degree of protection (IEC EN 60529)	IP 20
Dimension (DIN 43880)	1 TE
Max. connection torque for terminals	3,5 Nm
Power supply system	between N and PE
Composed of: number of moduls	1x 38 80 07

#### Accessories: Module

	EL-T2-75-M	EL-T2-130-M	EL-T2-275-M	EL-T2-350-M	EL-T2-440-M	EL-T2-550-M	EL-T2-750-M	EL-T2-NPE-M
Article-No.	38 80 00	38 80 01	38 80 02	38 80 03	38 80 04	38 80 05	38 80 06	38 80 07

Replacement plug-in module with varistor for 75/130/275/350/440/550/750 V AC plus Module with NPE.



## SPD type 2 for AC power supplies / EnerPro

### EnerPro C

Multipole compact surge protective devices for the use in e. g. 3 phase TNS, TT, TNC systems and 2 phase TT1+1, TN and IT systems.



example image

- Monitoring of conductor and arrester via LED
- Inflammability class according to UL 94 V0
- EAC certification
- Test standard: IEC 61643-11 / EN 61643-11
- Remote signalling contact (FM): break contact
- Switching capacity FM: 250 V/2 A
- Max. conductor cross section FM: 1,5 mm<sup>2</sup>
- Leakage current-free

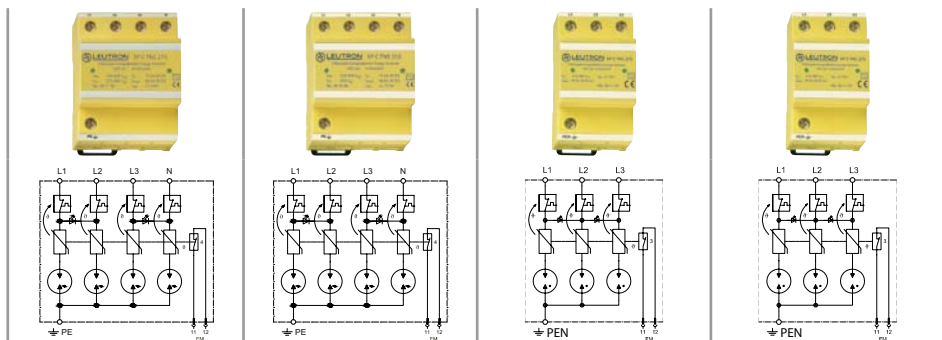

#### Technical Data

Product name	EP C TNS 275/FM	EP C TNS 350/FM	EP C TNC 275/FM	EP C TNC 350/FM
Article-No.	38 11 79	38 55 90	38 11 77	38 55 70
IEC category	Type 2 / class II	Type 2 / class II	Type 2 / class II	Type 2 / class II
Nominal voltage AC	UN 230/400 V~	230/400 V~	230/400 V~	230/400 V~
Max. continuous operating voltage AC (50/60Hz)	Uc 275/480 V~	350 V~	275/480 V~	350 V~
Protection level at 5 kA	Up ≤ 1,0 kV	≤ 1,3 kV	≤ 1,0 kV	≤ 1,3 kV
Protection level at In (8/20 μs)	Up ≤ 1,4 kV	≤ 1,75 kV	≤ 1,4 kV	≤ 1,75 kV
Response time	tA <25 ns	<25 ns	<25 ns	<25 ns
Nominal discharge current (8/20 μs)	In 15 kA	15 kA	15 kA	15 kA
Max. impulse discharge current (8/20 μs)	Imax 40 kA	40 kA	40 kA	40 kA
Max. allowed fuse or back-up fuse	125 A gG	125 A gG	125 A gG	125 A gG
Operating temperature range	TU -40 - +80 °C	-40 - +80 °C	-40 - +80 °C	-40 - +80 °C
Max. conductor cross section	stranded 35/fine stranded 25 mm <sup>2</sup>		stranded 35/fine stranded 25 mm <sup>2</sup>	
Recommended conductor cross section	16 mm <sup>2</sup>	16 mm <sup>2</sup>	16 mm <sup>2</sup>	16 mm <sup>2</sup>
Max. connection torque for terminals	4,0 Nm	4,0 Nm	4,0 Nm	4,0 Nm
Enclosure material / colour	Polycarbonate UL 94-V0 / yellow	Polycarbonate UL 94-V0 / yellow	Polycarbonate UL 94-V0 / yellow	Polycarbonate UL 94-V0 / yellow
Degree of protection (IEC EN 60529)	IP 20	IP 20	IP 20	IP 20
Mounting on	35 mm DIN rail (EN 60715)	35 mm DIN rail (EN 60715)	35 mm DIN rail (EN 60715)	35 mm DIN rail (EN 60715)
Power supply system	3 phase TNS systems	3 phase TNS systems	3 phase TNC systems	3 phase TNC systems



### SPD type 2 for AC power supplies / EnerPro

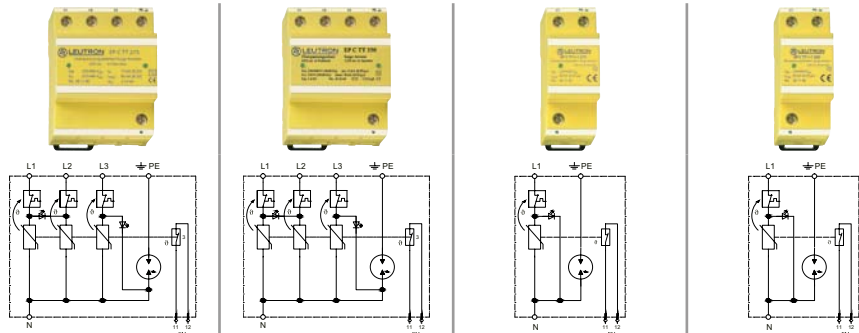

#### Technical Data

Product name	EP C TT 275/FM	EP C TT 350/FM	EP C TT1+1 275/FM	EP C TT1+1 350/FM
Article-No.	38 11 81	38 56 10	38 11 83	38 11 91
IEC category	Type 2 / class II	Type 2 / class II	Type 2 / class II	Type 2 / class II
Nominal voltage AC	UN 230/400 V~	230/400 (240/415) V~	230/400 V~	230/400 (240/415) V~
Max. continuous operating voltage AC (50/60Hz)	Uc 275/480 V~	350 V~	275/480 V~	350 V~
Protection level at 5 kA	Up ≤ 1,0 kV	≤ 1,0 kV	≤ 1,0 kV	≤ 1,0 kV
Protection level at In	Up ≤ 1,4 kV	≤ 1,4 kV	≤ 1,4 kV	≤ 1,4 kV
Response time	tA <25 ns	< 50 ns	<25 ns	< 50 ns
Nominal discharge current (8/20 μs)	In 15 kA	15 kA	15 kA	15 kA
Max. impulse discharge current (8/20 μs)	I <sub>max</sub> 40 kA	40 kA	40 kA	40 kA
Lightning impulse current (10/350 μs) N-PE	I <sub>imp</sub> 12 kA	12 kA	12 kA	12 kA
Max. allowed fuse or back-up fuse	125 A gG	125 A gG	125 A gG	125 A gG
Operating temperature range	TU -40 - +80 °C	-40 - +80 °C	-40 - +80 °C	-40 - +80 °C
Max. conductor cross section	stranded 35/fine stranded 25 mm <sup>2</sup>		stranded 35/fine stranded 25 mm <sup>2</sup>	
Recommended conductor cross section	16 mm <sup>2</sup>	16 mm <sup>2</sup>	16 mm <sup>2</sup>	16 mm <sup>2</sup>
Max. connection torque for terminals	4,0 Nm	4,0 Nm	4,0 Nm	4,0 Nm
Enclosure material / colour	Polycarbonate UL 94-V0 / yellow	Polycarbonate UL 94-V0 / yellow	Polycarbonate UL 94-V0 / yellow	Polycarbonate UL 94-V0 / yellow
Degree of protection (IEC EN 60529)	IP 20	IP 20	IP 20	IP 20
Mounting on	35 mm DIN rail (EN 60715)	35 mm DIN rail (EN 60715)	35 mm DIN rail (EN 60715)	35 mm DIN rail (EN 60715)
Power supply system	3 phase TT systems	3 phase TT systems	1 phase TT systems	1 phase TT systems

#### Dimension

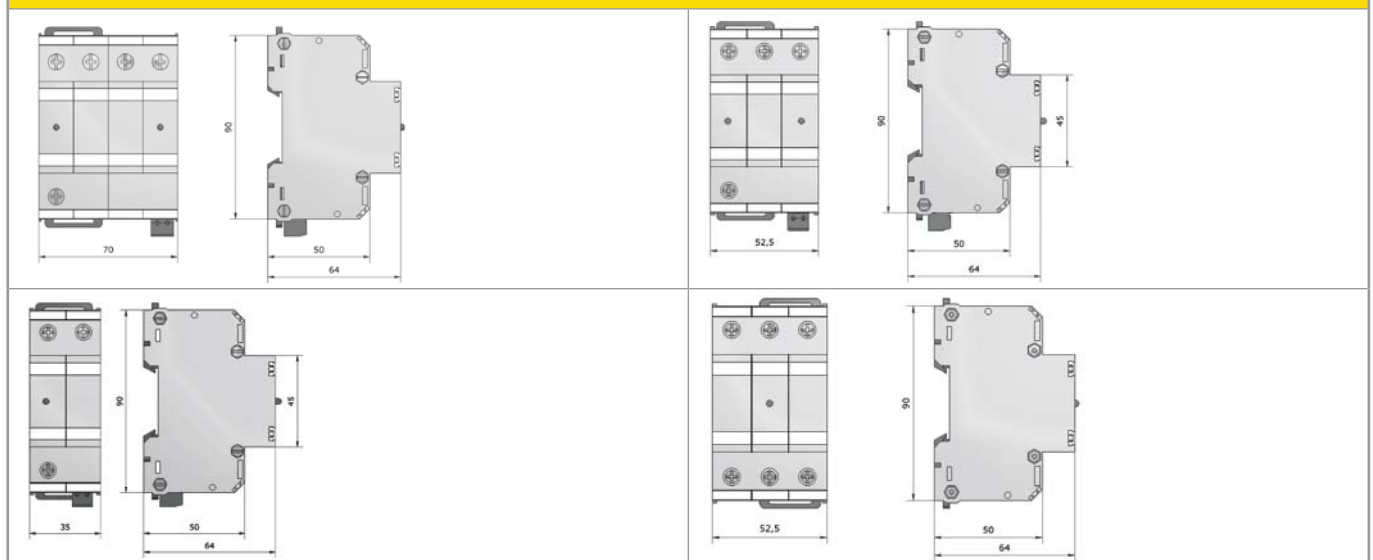





### SPD type 2 for AC power supplies / EnerPro

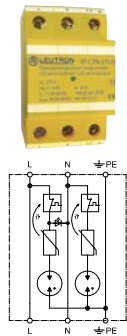
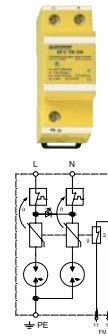
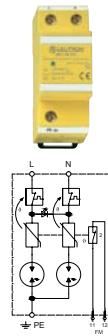
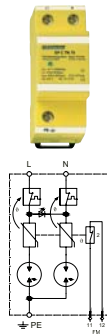

#### Technical Data

Product name	EP C TN 75/FM	EP C TN 275/FM	EP C TN 350/FM	EP C TN 275-D
Article-No.	38 14 05	38 12 48	38 55 50	38 12 52
IEC category	Type 2 / class II	Type 2 / class II	Type 2 / class II	Type 2 / class II
Nominal voltage AC	UN 60 V~	230/400 V~	230/400 V~	230 V~
Max. continuous operating voltage AC (50/60Hz)	Uc 75 V~	275/480 V~	350 V~	275 V~
Protection level at 5 kA	Up ≤ 0,3 kV	≤ 1,0 kV	≤ 1,3 kV	≤ 1,0 kV
Protection level at In (8/20 μs)	Up ≤ 0,55 kV	≤ 1,4 kV	≤ 1,75 kV	≤ 1,4 kV
Response time	tA <50 ns	<25 ns	<25 ns	< 50 ns
Nominal discharge current (8/20 μs)	In 15 kA	15 kA	15 kA	15 kA
Max. impulse discharge current (8/20 μs)	Imax 40 kA	40 kA	40 kA	40 kA
Max. allowed fuse or back-up fuse	125 A gG	125 A gG	125 A gG	125 A gG
Operating temperature range	TU -40 - +80 °C	-40 - +80 °C	-40 - +80 °C	-40 - +80 °C
Max. conductor cross section	stranded 35/fine stranded 25 mm <sup>2</sup>		stranded 35/fine stranded 25 mm <sup>2</sup>	
Recommended conductor cross section	16 mm <sup>2</sup>	16 mm <sup>2</sup>	16 mm <sup>2</sup>	16 mm <sup>2</sup>
Max. connection torque for terminals	4,0 Nm	4,0 Nm	4,0 Nm	4,0 Nm
Enclosure material / colour	Polycarbonate UL 94-V0 / yellow	Polycarbonate UL 94-V0 / yellow	Polycarbonate UL 94-V0 / yellow	Polycarbonate UL 94-V0 / yellow
Degree of protection (IEC EN 60529)	IP 20	IP 20	IP 20	IP 20
Mounting on	35 mm DIN rail (EN 60715)	35 mm DIN rail (EN 60715)	35 mm DIN rail (EN 60715)	35 mm DIN rail (EN 60715)
Power supply system	1 phase TN systems	1 phase TN systems	1 phase TN systems	1 phase TN systems



### SPD type 2 for AC power supplies / EnerPro

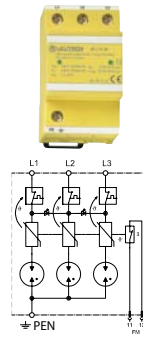
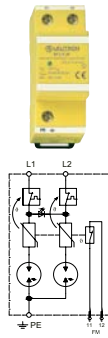

#### Technical Data

Product name	EP C IT 2P/FM	EP C IT 3P/FM
Article-No.	38 15 01	38 15 11
IEC category	Type 2 / class II	Type 2 / class II
Nominal voltage AC	UN 230 V~	230 V~
Max. continuous operating voltage AC (50/60Hz)	Uc 440 V~	440 V~
Protection level at 5 kA	Up ≤ 1.5 kV	≤ 1.5 kV
Protection level at In (8/20 μs)	Up ≤ 2.2 kV	≤ 2.2 kV
Response time	tA < 25 ns	< 25 ns
Nominal impulse discharge current (10 x 8/20 μs)	In 15 kA	15 kA
Max. impulse discharge current (8/20 μs)	I <sub>max</sub> 30 kA	30 kA
Max. allowed fuse or back-up fuse	125 A gG	125 A gG
Operating temperature range	TU -40 - +80 °C	-40 - +80 °C
Max. conductor cross section	35mm <sup>2</sup> stranded/25mm <sup>2</sup> flexible	
Recommended conductor cross section	25 mm <sup>2</sup>	16 mm <sup>2</sup>
Max. connection torque for terminals	4,0 Nm	4,0 Nm
Enclosure material / colour	Polycarbonate UL 94-V0 / yellow	Polycarbonate UL 94-V0 / yellow
Degree of protection (IEC EN 60529)	IP 20	IP 20
Mounting on	35 mm DIN rail (EN 60715)	35 mm DIN rail (EN 60715)
Power supply system	2 phase IT systems	3 phase IT systems

## SPD type 2 for AC power supplies / EnerPro

### EnerPro 280Tr

Slim and leakage-current free 2-pole surge arrester, e.g. for a 1-phase TN system. Only 1 MW according to DIN 43880.

- Monitoring of conductor and arrester via LED
- Remote signalling contact (Pk): break contact
- EAC certification

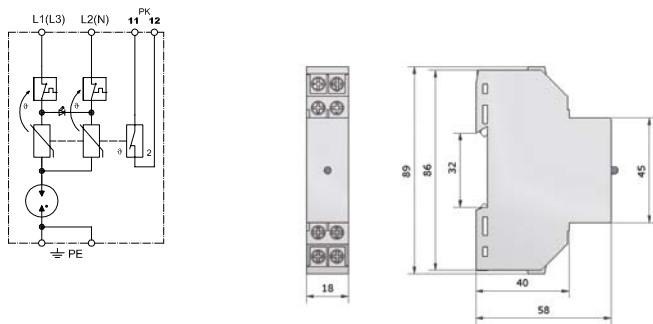

Technical Data		
<b>Product name</b>	<b>EnerPro 280Tr/Pk</b>	
Article-No.	38 20 29	
IEC category	Type 2 / class II	
Nominal voltage AC	UN	230/400 V~
Max. continuous operating voltage AC (50/60Hz)	Uc	275/480 V~
Protection level at 5 kA	Up	≤ 1,0 kV
Protection level at In (L(N)-PE)	Up	≤ 1,4 kV
Response time	tA	≤ 50 ns
Nominal discharge current (8/20 μs) L(N)-PE	In	15 kA
Max. impulse discharge current (8/20 μs)	Imax	18 kA
Max. allowed fuse or back-up fuse	125 A gG	
Operating temperature range	TU	-40 - +80 °C
Enclosure material / colour	Polycarbonate UL 94-V0 / yellow	
Mounting on	35 mm DIN rail (EN 60715)	
Switching capacity	250 V/2 A	
Max. conductor cross section Pk	2.5mm <sup>2</sup> solid or 1.5mm <sup>2</sup> flexible with sleeve	

### EnerPro 282Tr-M

- SPD based on NPE isolating spark gap technology for TT systems
- leakage current-free
- Monitoring of conductor and arrester via LED
- Remote signalling contact (Pk): break contact
- Degree of protection nach IEC EN 60529: IP 20
- Mounting on 35 mm DIN rail (EN 60715)
- EAC certification

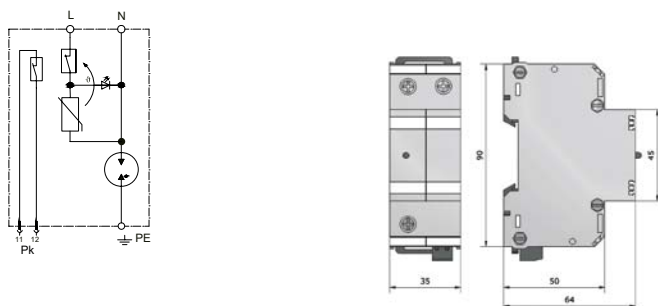

Technical Data		
<b>Product name</b>	<b>EnerPro 282Tr-M/Pk</b>	
Article-No.	38 20 45	
IEC category	Type 2 / class II	
Nominal voltage AC	UN	230 V~
Max. continuous operating voltage DC	Uc	275 V=
Response time at 10 kV/μs	tA	< 5 ns
Protection level at 1kV/μs (L(N)-PE)	Up	≤ 1,4 kV
Protection level at In (L(N)-PE)	Up	≤ 1,4 kV
Nominal discharge current L-PE (8/20 μs)	In	10x 15 kA
Nominal discharge current (8/20 μs)	In	40 kA
Service life test current (10/700μs)	IL	500x 100, 10x 500, 1x 40 A
Lightning impulse current (10/350μs) N-PE	Iimp	12 kA
Max. allowed fuse or back-up fuse	125 A gG	
Operating temperature range	TU	-40 - +80 °C
Max. conductor cross section	stranded 35/fine stranded 25 mm <sup>2</sup>	
Max. connection torque for terminals	4,0 Nm	
Enclosure material / colour	Polycarbonate UL 94-V0 / yellow	
Switching capacity	250 V/2 A	
Max. conductor cross section Pk	1,5 mm <sup>2</sup>	



### SPD type 2 for AC power supplies / EnerPro

#### EnerPro 284Tr-M

- Function control indication via LED
- Degree of protection nach IEC EN 60529: IP 20
- Mounting on 35 mm DIN rail (EN 60715)
- EAC certification
- Remote signalling contact (Pk): break contact
- Switching capacity Pk: 250 V/2 A
- Max. conductor cross section Pk: 1,5 mm<sup>2</sup>

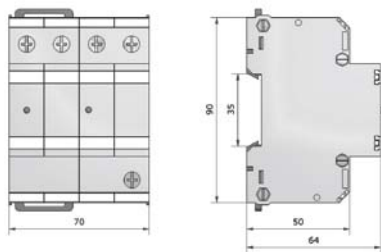
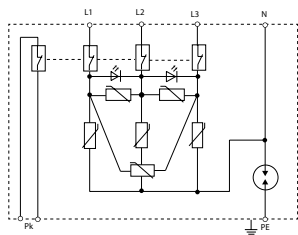



Technical Data		
<b>Product name</b>	<b>EnerPro 284Tr-M/Pk</b>	
Article-No.	38 20 43	
IEC category	Type 2 / class II	
Nominal voltage DC	UN	500 (N-PE) V=
Nominal voltage AC	UN	230/400 V~
Max. continuous operating voltage AC (50/60 Hz)	Uc	275 V~
Insulation resistance	Risol	≥ 10 GΩ
Impulse sparkover voltage (1.2/50 μs)	Uas	≤ 1,4 (N/PE) ≤ 1,5 kV
Response time at 10 kV/μs	tA	< 5 ns
Protection level at 5 kA (8/20 μs)	Up	≤ 800 V
Nominal impulse discharge current (8/20 μs)	In	10x 15 kA
Max. impulse discharge current (8/20 μs)	Imax	1x 40 kA
Lightning impulse current (10/350) N-PE	Iimp	12 kA
Max. acceptable fuse or back-up fuse		125 A gG
Short-circuit current extinguishing capacity line-earth		100 A
Operating temperature range	TU	-40 - +80 °C
Max. conductor cross section		50mm <sup>2</sup> stranded/35mm <sup>2</sup> flexible
Recommended conductor cross section		25 mm <sup>2</sup>
Max. connection torque for terminals		4,0 Nm
Power supply system		3 phase TNS and TT systems

#### EnerPro 150Tr/Pk

Surge protection for equipment and installations up to 100 A and 150 V.

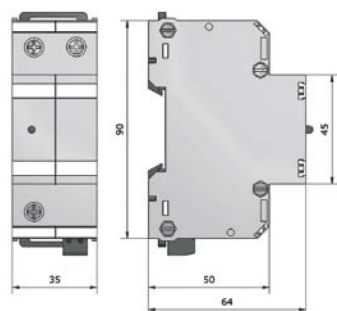
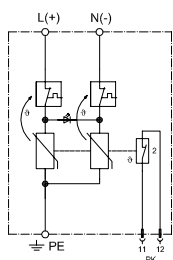
- High performance arrester for 150 V operating voltage
- Line function and equipment control by LED
- Remote signalling contact (Pk): break contact
- EAC certification



Technical Data		
<b>Product name</b>	<b>EnerPro 150Tr/Pk</b>	
Article-No.	38 20 25	
IEC category	Type 2 + 3 / class II+III	
Nominal voltage DC	UN	150 V=
Max. continuous operating voltage AC (50/60Hz)	Uc	170 V~
Protection level	Up	≤ 1,0 kV
Lightning impulse current (10/350 μs)	Iimp	8 kA
Max. impulse discharge current (8/20 μs)	Imax	40 kA
Max. allowed fuse or back-up fuse		125 A gG
Response time	tA	≤ 25 ns
Max. conductor cross section		50mm <sup>2</sup> stranded/35mm <sup>2</sup> flexible
Max. Locking torque Klemmen		1,5 Nm
Operating temperature range	TU	-40 - +80 °C
Enclosure material / colour		Polycarbonate UL 94-V0 / yellow
Degree of protection (IEC EN 60529)		IP 20
Mounting on		35 mm DIN rail (EN 60715)
Switching capacity		250 V/2 A
Max. conductor cross section Pk		1,5 mm <sup>2</sup>



## SPD type 3 for AC power supplies

### CT-T3/xxV-16/25A-FM

The SPD is applicable at the transition 2-3 according to the lightning protection zones concept. Pluggable 2-pole surge arrester type 3 (class III) for TN systems with 16 or 25 Ampere (24 up to 275 Volt).



- Line function and equipment control by LED
- Leakage current free
- Remote signalling contact: break contact
- Mounting on 35 mm Hutschiene (EN 60715)
- Degree of protection according to IEC EN 60529: IP 20
- Space required for installation: 17.5 mm
- Test standard: IEC 61643-11 / EN 61643-11
- EAC certification
- Shock test standard: DIN EN 60068-2-27, IEC 60068-2-27
- Vibration test standard: DIN EN 60068-2-6, IEC 60068-2-6

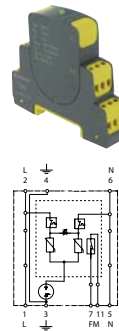
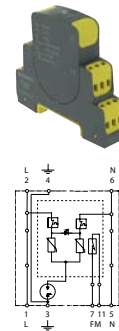
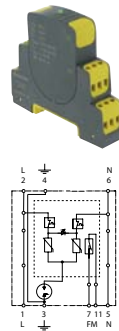
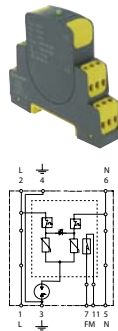
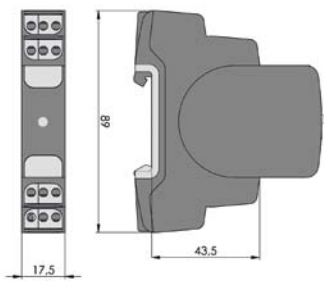

#### Technical Data

Product name	CT-T3/24V-16A-FM	CT-T3/48V-16A-FM	CT-T3/60V-16A-FM	CT-T3/120V-16A-FM
Article-No.	38 00 13	38 00 16	38 00 19	38 00 22
IEC category	Type 3 / class III	Type 3 / class III	Type 3 / class III	Type 3 / class III
Nominal voltage AC	UN 24 V~	48 V~	60 V~	120 V~
Max. continuous operating voltage AC (50/60Hz)	Uc 30 V~	60 V~	75 V~	150 V~
Rated load current	IL 16 A	16 A	16 A	16 A
Protection level L-N	Up ≤ 0,22 kV	≤ 0,35 kV	≤ 0,5 kV	≤ 0,7 kV
Protection level L/N-PE	Up ≤ 1,0 kV	≤ 1,0 kV	≤ 1,0 kV	≤ 1,0 kV
Combined surge	Uoc ≤ 2,0 kV	≤ 2,0 kV	≤ 2,0 kV	≤ 4,0 kV
Response time L-N/L,N-PE	≤ 25/≤ 100 ns	≤ 25/≤ 100 ns	≤ 25/≤ 100 ns	≤ 25/≤ 100 ns
Nominal impulse discharge current (10 x 8/20 μs)	In 5 kA	5 kA	5 kA	5 kA
Max. impulse discharge current (8/20 μs)	Imax 8 kA	8 kA	8 kA	8 kA
Max. allowed fuse or back-up fuse	16 A gG	16 A gG	16 A gG	16 A gG
Operating temperature range	TU -40 - +80 °C	-40 - +80 °C	-40 - +80 °C	-40 - +80 °C
Conductor cross section (solid/stranded/AWG)	0.2-4.0/0.2-2.5 mm <sup>2</sup> / 24-12	0.2-4.0/0.2-2.5 mm <sup>2</sup> / 24-12	0.2-4.0/0.2-2.5 mm <sup>2</sup> / 24-12	0.2-4.0/0.2-2.5 mm <sup>2</sup> / 24-12
Locking torque	0,4 Nm	0,4 Nm	0,4 Nm	0,4 Nm
Enclosure material / colour	Thermoplastic, yellow/black, UL 97 V-0		Thermoplastic, yellow/black, UL 97 V-0	



### SPD type 3 for AC power supplies

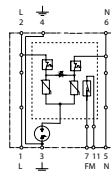
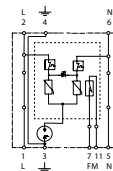
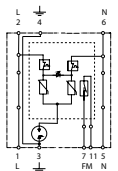
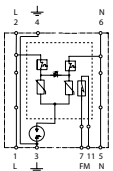

#### Technical Data

Product name	CT-T3/230V-16A-FM	CT-T3/275V-16A-FM	CT-T3/24V-25A-FM	CT-T3/48V-25A-FM
Article-No.	38 00 25	38 00 28	38 00 14	38 00 17
IEC category	Type 3 / class III	Type 3 / class III	Type 3 / class III	Type 3 / class III
Nominal voltage AC	UN 230 V~	230 V~	24 V~	48 V~
Max. continuous operating voltage AC (50/60Hz)	Uc 255 V~	275 V~	30 V~	60 V~
Rated load current	IL 16 A	16 A	25 A	25 A
Protection level L-N	Up ≤ 1,0 kV	≤ 1,0 kV	≤ 0,22 kV	≤ 0,35 kV
Protection level L/N-PE	Up ≤ 1,5 kV	≤ 1,5 kV	≤ 1,0 kV	≤ 1,0 kV
Combined surge	Uoc ≤ 4,0 kV	≤ 4,0 kV	≤ 2,0 kV	≤ 2,0 kV
Response time L-N/L,N-PE	≤ 25/≤ 100 ns	≤ 25/≤ 50 ns	≤ 25/≤ 100 ns	≤ 25/≤ 100 ns
Nominal impulse discharge current (10 x 8/20 μs)	In 5 kA	5 kA	5 kA	5 kA
Max. impulse discharge current (8/20 μs)	I <sub>max</sub> 8 kA	8 kA	8 kA	8 kA
Max. allowed fuse or back-up fuse	16 A gG	16 A gG	25 A gG	25 A gG
Operating temperature range	TU -40 - +80 °C	-40 - +80 °C	-40 - +80 °C	-40 - +80 °C
Conductor cross section (solid/stranded/AWG)	0.2-4.0/0.2-2.5 mm <sup>2</sup> / 24-12	0.2-4.0/0.2-2.5 mm <sup>2</sup> / 24-12	0.2-4.0/0.2-2.5 mm <sup>2</sup> / 24-12	0.2-4.0/0.2-2.5 mm <sup>2</sup> / 24-12
Enclosure material / colour	Thermoplastic, yellow/black, UL 97 V-0		Thermoplastic, yellow/black, UL 97 V-0	

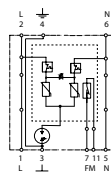
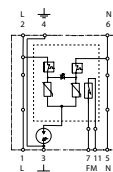
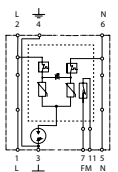
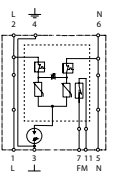

#### Technical Data

Product name	CT-T3/60V-25A-FM	CT-T3/120V-25A-FM	CT-T3/230V-25A-FM	CT-T3/275V-25A-FM
Article-No.	38 00 20	38 00 23	38 00 26	38 00 29
IEC category	Type 3 / class III	Type 3 / class III	Type 3 / class III	Type 3 / class III
Nominal voltage AC	UN 60 V~	120 V~	230 V~	230 V~
Max. continuous operating voltage AC (50/60Hz)	Uc 75 V~	150 V~	255 V~	275 V~
Rated load current	IL 25 A	25 A	25 A	25 A
Protection level L-N	Up ≤ 0,5 kV	≤ 0,7 kV	≤ 1,0 kV	≤ 1,0 kV
Protection level L/N-PE	Up ≤ 1,0 kV	≤ 1,0 kV	≤ 1,5 kV	≤ 1,5 kV
Combined surge	Uoc ≤ 2,0 kV	≤ 4,0 kV	≤ 4,0 kV	≤ 4,0 kV
Response time L-N/L,N-PE	≤ 25/≤ 100 ns	≤ 25/≤ 100 ns	≤ 25/≤ 100 ns	≤ 25/≤ 50 ns
Nominal impulse discharge current (10 x 8/20 μs)	In 5 kA	5 kA	5 kA	5 kA
Max. impulse discharge current (8/20 μs)	I <sub>max</sub> 8 kA	8 kA	8 kA	8 kA
Max. allowed fuse or back-up fuse	25 A gG	25 A gG	25 A gG	25 A gG
Operating temperature range	TU -40 - +80 °C	-40 - +80 °C	-40 - +80 °C	-40 - +80 °C
Conductor cross section (solid/stranded/AWG)	0.2-4.0/0.2-2.5 mm <sup>2</sup> / 24-12	0.2-4.0/0.2-2.5 mm <sup>2</sup> / 24-12	0.2-4.0/0.2-2.5 mm <sup>2</sup> / 24-12	0.2-4.0/0.2-2.5 mm <sup>2</sup> / 24-12
Locking torque	1,5 Nm	1,5 Nm	1,5 Nm	1,5 Nm
Enclosure material / colour	Thermoplastic, yellow/black, UL 97 V-0		Thermoplastic, yellow/black, UL 97 V-0	



## SPD type 3 for AC power supplies

### EnerPro D

Three pole compact surge protective device e. g. for 1, 2 and 3 phase systems (TNS-, TT-, TNC- and IT-systems). The SPD is applicable at the transition 2-3 according to the lightning protection zones concept.



Image example

- Deepest protection against longitudinal and transverse voltages for loads up to 16 A
  - Possible with parallel or spur wiring for >16 A
  - Line function and equipment control by LED
  - Inflammability class according to UL 94 V0
- Leakage current free
  - Remote signalling contact (FM): break contact
  - Mounting on 35 mm DIN rail (EN 60715)
  - EAC certification

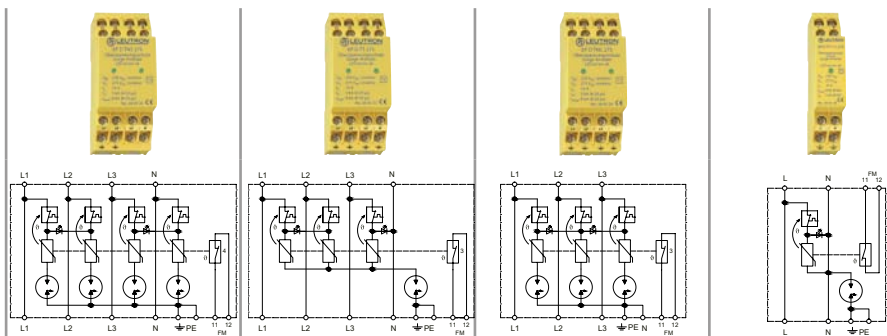

#### Technical Data

Product name	EP D TNS 275/FM	EP D TT 275/FM	EP D TNC 275/FM	EP D TT1+1 275/FM
Article-No.	38 05 31	38 05 36	38 05 25	38 05 39
IEC category	Type 3 / class III			
Nominal voltage AC	UN 230 V~	230 V~	230 V~	230 V~
Max. continuous operating voltage AC (50/60Hz)	Uc 275 V~	275 V~	275 V~	275 V~
Rated load current	IL 16 A	16 A	16 A	16 A
Protection level L-N	Up ≤ 1,0 kV	≤ 1,0 kV	≤ 1,0 kV	≤ 1,0 kV
Protection level L/N-PE	Up ≤ 1,5 kV	≤ 1,5 kV	≤ 1,5 kV	≤ 1,5 kV
Combined surge	Uoc ≤ 4,0 kV	≤ 4,0 kV	≤ 4,0 kV	≤ 4,0 kV
Nominal impulse discharge current (8/20 μs)	In 5 kA	5 kA	5 kA	5 kA
Max. impulse discharge current (8/20 μs)	Imax 8 kA	8 kA	8 kA	8 kA
Response time L-N/L,N-PE	≤ 25/≤ 50 ns			
Max. allowed fuse or back-up fuse	16 A gG			
Max. conductor cross section	2,5 mm <sup>2</sup> single-wire / 1,5 mm <sup>2</sup> flexible with sleeve			
Operating temperature range	TU -40 - +80 °C	-40 - +80 °C	-40 - +80 °C	-40 - +80 °C
Enclosure material / colour	Polycarbonate UL 94-V0 / yellow			
Degree of protection (IEC EN 60529)	IP 20			
Dimension (DIN 43880)	2 TE	2 TE	2 TE	1 TE
Power supply system	3 phase TNS systems	3 phase TNS and TT systems	3-phasige TNC-Systeme	1 phase TT systems
Switching capacity	250 V/2 A			
Max. conductor cross section FM	1,5 mm <sup>2</sup>			



### SPD type 3 for AC power supplies

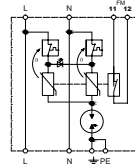
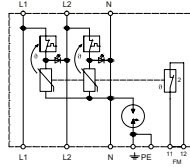

#### Technical Data

Product name	EP D TT2+1 275/FM	EP D IT 2P/FM
Article-No.	38 05 41	38 05 71
IEC category	Type 3 / class III	Type 3 / class III
Nominal voltage AC	UN 220 V~	230 V~
Max. continuous operating voltage AC (50/60Hz)	Uc 275 V~	440 V
Rated load current	IL 16 A	16 A
Protection level L-N	Up ≤ 1,0 kV	≤ 1,0 kV
Protection level L/N-PE	Up ≤ 1,5 kV	≤ 1,5 kV
Combined surge	Uoc ≤ 4,0 kV	≤ 6,0 kV
Response time L-N/L,N-PE	≤ 25/≤ 50 ns	≤ 25 ns
Nominal impulse discharge current (8/20 μs)	In 5 kA	5 kA
Max. impulse discharge current (8/20 μs)	I <sub>max</sub> 8 kA	8 kA
Max. allowed fuse or back-up fuse	16 A gG	16 A gG
Operating temperature range	TU -40 - +80 °C	-40 - +80 °C
Max. conductor cross section	2.5 mm <sup>2</sup> single-wire / 1.5 mm <sup>2</sup> flexible with sleeve	
Max. Locking torque Klemmen	1,5 Nm	1,5 Nm
Degree of protection (IEC EN 60529)	IP 20	IP 20
Enclosure material / colour	Polycarbonate UL 94-V0 / yellow	Polycarbonate UL 94-V0 / yellow
Dimension (DIN 43880)	2 TE	1 TE
Power supply system	2 phase TT systems	1 phase IT systems
Switching capacity	250 V/2 A	250 V/2 A
Max. conductor cross section FM	1,5 mm <sup>2</sup>	1,5 mm <sup>2</sup>

#### Dimension

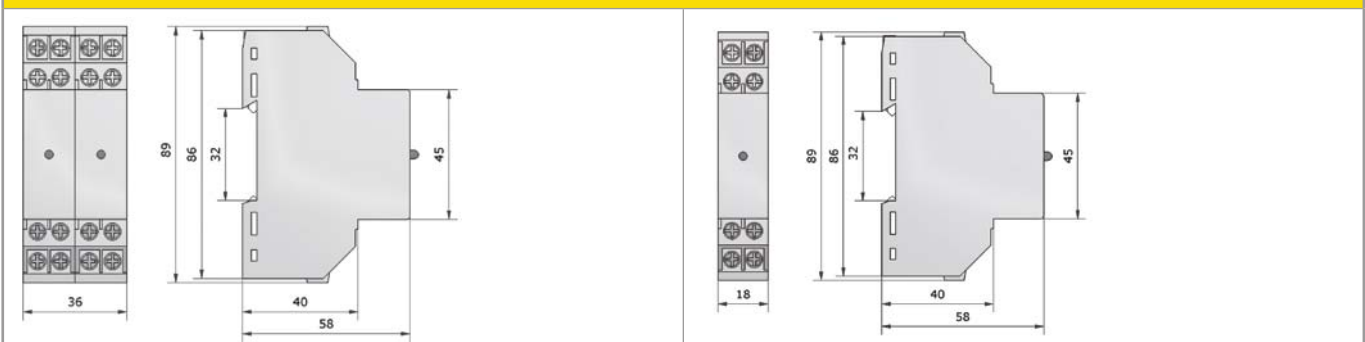





## SPD type 3 for AC power supplies

### EnerPro D TN

Compact 2-pole surge arrester type 3 (class III) for rated voltages from 24 up to 230 Volt in TN systems up to 16 or 25 Ampere.

The SPD is applicable at the transition 2-3 according to the lightning protection zones concept.



Image example

- Test standard: IEC 61643-11 / EN 61643-11
- Line function and equipment control by LED
- Leakage current free
- Practical compact housing with minimum space requirement
- Inflammability class according to UL 94 V0
- Remote signalling contact (FM): break contact
- Mounting on 35 mm DIN rail (EN 60715)
- EAC certification
- Space required for installation: 18 mm (1 TE)

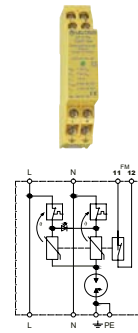
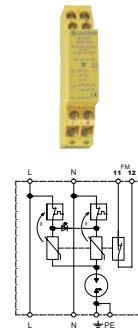
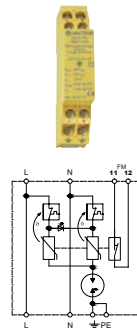
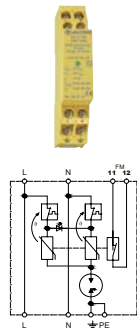
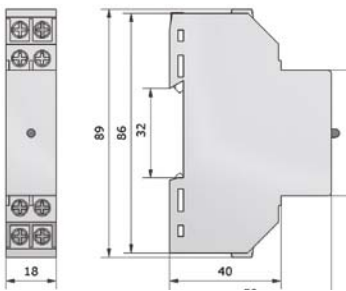

#### Technical Data

Product name	EP D TN 24V/16A/FM	EP D TN 48V/16A/FM	EP D TN 60V/16A/FM	EP D TN 120V/16A/FM
Article-No.	38 05 51	38 05 54	38 05 57	38 05 60
IEC category	Type 3 / class III	Type 3 / class III	Type 3 / class III	Type 3 / class III
Nominal voltage AC	UN 24 V~	48 V~	60 V~	120 V~
Max. continuous operating voltage AC (50/60Hz)	Uc 30 V~	60 V~	75 V~	150 V~
Rated load current	IL 16 A	16 A	16 A	16 A
Protection level L-N	Up ≤ 0,22 kV	≤ 0,35 kV	≤ 0,5 kV	≤ 0,7 kV
Protection level L/N-PE	Up ≤ 1,0 kV	≤ 1,0 kV	≤ 1,0 kV	≤ 1,0 kV
Combined surge	Uoc ≤ 2,0 kV	≤ 2,0 kV	≤ 2,0 kV	≤ 2,0 kV
Response time L-N/L,N-PE	≤ 25/≤ 100 ns	≤ 25/≤ 100 ns	≤ 25/≤ 100 ns	≤ 25/≤ 100 ns
Nominal impulse discharge current (10 x 8/20 μs)	In 5 kA	5 kA	5 kA	5 kA
Max. impulse discharge current (8/20 μs)	I <sub>max</sub> 8 kA	8 kA	8 kA	8 kA
Max. allowed fuse or back-up fuse	16 A gG	16 A gG	16 A gG	16 A gG
Operating temperature range	TU -40 - +80 °C	-40 - +80 °C	-40 - +80 °C	-40 - +80 °C
Min. conductor cross section	1.5 mm <sup>2</sup> single-wire / 1.0 mm <sup>2</sup> flexible with sleeve		1.5 mm <sup>2</sup> single-wire / 1.0 mm <sup>2</sup> flexible with sleeve	
Max. conductor cross section	2.5 mm <sup>2</sup> single-wire / 1.5 mm <sup>2</sup> flexible with sleeve		2.5 mm <sup>2</sup> single-wire / 1.5 mm <sup>2</sup> flexible with sleeve	
Max. locking torque FM terminals	1,5 Nm	1,5 Nm	1,5 Nm	1,5 Nm
Enclosure material / colour	Polycarbonate UL 94-V0 / yellow	Polycarbonate UL 94-V0 / yellow	Polycarbonate UL 94-V0 / yellow	Polycarbonate UL 94-V0 / yellow
Degree of protection (IEC EN 60529)	IP 20	IP 20	IP 20	IP 20
Switching capacity	250 V/2 A	250 V/2 A	250 V/2 A	250 V/2 A
Max. conductor cross section FM	1,5 mm <sup>2</sup>	1,5 mm <sup>2</sup>	1,5 mm <sup>2</sup>	1,5 mm <sup>2</sup>



### SPD type 3 for AC power supplies

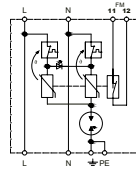
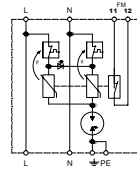
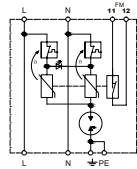
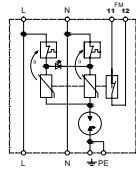

#### Technical Data

Product name	EP D TN 230V/16A/FM	EP D TN 275V/FM	EP D TN 24V/25A-FM	EP D TN 48V/25A-FM
Article-No.	38 05 63	38 12 55	38 05 55	38 05 58
IEC category	Type 3 / class III			
Nominal voltage AC	UN 230 V~	230 V~	24 V~	48 V~
Max. continuous operating voltage AC (50/60Hz)	Uc 255 V~	275 V~	30 V~	60 V~
Rated load current	IL 16 A	16 A	25 A	25 A
Protection level L-N	Up ≤ 1,0 kV	≤ 1,0 kV	≤ 0,22 kV	≤ 0,35 kV
Protection level L/N-PE	Up ≤ 1,7 kV	≤ 1,5 kV	≤ 1,0 kV	≤ 1,0 kV
Combined surge	Uoc ≤ 4,0 kV	≤ 4,0 kV	2 kV	≤ 2,0 kV
Response time L-N/L,N-PE	≤ 25/≤ 100 ns			
Nominal impulse discharge current (10 x 8/20 μs)	In 5 kA	5 kA	5 kA	5 kA
Max. impulse discharge current (8/20 μs)	I <sub>max</sub> 8 kA	8 kA	8 kA	8 kA
Max. allowed fuse or back-up fuse	16 A gG	16 A gG	25 A gG	25 A gG
Operating temperature range	TU -40 - +80 °C	-40 - +80 °C	-40 - +80 °C	-40 - +80 °C
Min. conductor cross section	1.5 mm <sup>2</sup> single-wire / 1.0 mm <sup>2</sup> flexible with sleeve		1.5 mm <sup>2</sup> single-wire / 1.0 mm <sup>2</sup> flexible with sleeve	
Max. conductor cross section	2.5 mm <sup>2</sup> single-wire / 1.5 mm <sup>2</sup> flexible with sleeve		2.5 mm <sup>2</sup> single-wire / 1.5 mm <sup>2</sup> flexible with sleeve	
Max. locking torque FM terminals	1,5 Nm	1,5 Nm	1,5 Nm	1,5 Nm
Enclosure material / colour	Polycarbonate UL 94-V0 / yellow			
Degree of protection (IEC EN 60529)	IP 20			
Switching capacity	250 V/2 A			
Max. conductor cross section FM	1,5 mm <sup>2</sup>			



### SPD type 3 for AC power supplies

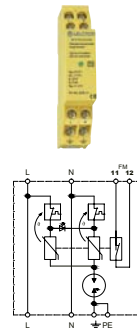
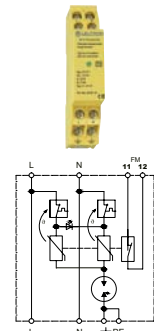
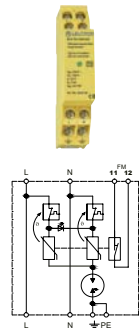
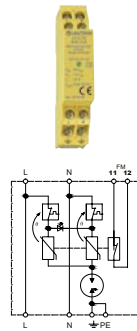

#### Technical Data

Product name	EP D TN 60V/25A-FM	EP D TN 120V/25A-FM	EP D TN 230V/25A-FM	EP D TN 275V/25A-FM
Article-No.	38 05 65	38 05 67	38 05 69	38 05 48
IEC category	Type 3 / class III			
Nominal voltage AC	UN 60 V~	120 V~	230 V~	230 V~
Max. continuous operating voltage AC (50/60Hz)	Uc 75 V~	150 V~	255 V~	275 V~
Rated load current	IL 25 A			
Protection level L-N	Up ≤ 0,5 kV	≤ 0,7 kV	≤ 1,0 kV	≤ 1,0 kV
Protection level L/N-PE	Up ≤ 1,0 kV	≤ 1,0 kV	≤ 1,7 kV	≤ 1,5 kV
Combined surge	Uoc ≤ 2,0 kV	≤ 2,0 kV	≤ 4,0 kV	≤ 4,0 kV
Response time L-N/L,N-PE	≤ 25/≤ 100 ns			
Nominal impulse discharge current (10 x 8/20 μs)	In 5 kA	5 kA	5 kA	5 kA
Max. impulse discharge current (8/20 μs)	I <sub>max</sub> 8 kA	8 kA	8 kA	8 kA
Max. allowed fuse or back-up fuse	25 A gG			
Operating temperature range	TU -40 - +80 °C	-40 - +80 °C	-40 - +80 °C	-40 - +80 °C
Min. conductor cross section	1.5 mm <sup>2</sup> single-wire / 1.0 mm <sup>2</sup> flexible with sleeve		1.5 mm <sup>2</sup> single-wire / 1.0 mm <sup>2</sup> flexible with sleeve	
Max. conductor cross section	2.5 mm <sup>2</sup> single-wire / 1.5 mm <sup>2</sup> flexible with sleeve		2.5 mm <sup>2</sup> single-wire / 1.5 mm <sup>2</sup> flexible with sleeve	
Max. locking torque FM terminals	1,5 Nm	1,5 Nm	1,5 Nm	1,5 Nm
Enclosure material / colour	Polycarbonate UL 94-V0 / yellow			
Degree of protection (IEC EN 60529)	IP 20			
Switching capacity	250 V/2 A			
Max. conductor cross section FM	1,5 mm <sup>2</sup>			



### SPD type 3 for AC power supplies

#### EnerPro 220Tr/20kA

Two-pole compact SPD with a discharge capacity of 20 kA (8/20  $\mu$ s) and disconnection device without interruption of the power supply (red LED).

- Leakage current-free
- Remote signalling contact (Pk): break contact
- Mounting on 35 mm DIN rail (EN 60715)
- Line function and equipment control by LED
- EAC certification

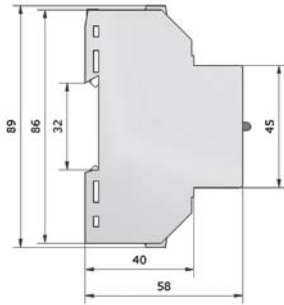
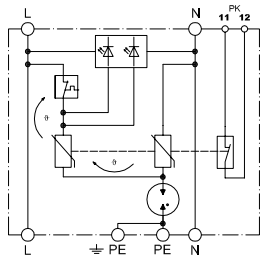

#### Technical Data

Product name	EnerPro 220Tr/20kA/PK
Article-No.	38 20 23
IEC category	Type 3 / class III
Nominal voltage AC	UN 230 V~
Max. continuous operating voltage AC (50/60Hz)	Uc 275 V~
Rated load current	IL 16 A
Max. allowed fuse or back-up fuse	16 A gG
Protection level L-N	Up $\leq 1,2$ kV
Protection level L/N-PE	Up $\leq 1,4$ kV
Response time L-N/L,N-PE	$\leq 25/\leq 50$ ns
Nominal impulse discharge current (8/20 $\mu$ s)	In 20 kA
Max. impulse discharge current (8/20 $\mu$ s)	I <sub>max</sub> 20 kA
Operating temperature range	TU -40 – +80 °C
Max. conductor cross section	2.5mm <sup>2</sup> solid or 1.5mm <sup>2</sup> flexible with sleeve
Recommended conductor cross section	1,5 / 2,5 mm <sup>2</sup>
Max. Locking torque terminals	1,5 Nm
Enclosure material / colour	Polycarbonate UL 94-V0 / yellow
Switching capacity	250 V/2 A



### SPD type 3 for AC power supplies

#### NM 220V

Surge voltage protection module for the protection of single-phase 230 V equipment with max. 16 A power consumption.



Image example

- Applicable at the LPZ transition point 2-3
- Test standard: IEC 61643-11 / EN 61643-11
- Compact module for equipment installation
- Protection against longitudinal and transverse voltages
- No leakage current to PE (leakage current free)
- Valve arrester SPD
- EAC certification

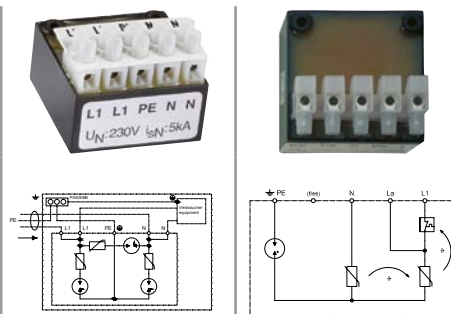

#### Technical Data

Product name	NM 220V/5kA	NM 220V/20kA/Pk
Article-No.	36 05 22	36 20 23
IEC category	Type 3 / class III	Type 3 / class III
Nominal voltage AC	UN 230 V~	230 V~
Rated load current	IL 16 A	16 A
Protection level L-N	Up ≤ 1,0 kV	≤ 1,2 kV
Protection level L/N-PE	Up ≤ 1,5 kV	≤ 1,4 kV
Response time	tA ≤ 25 ns	≤ 25/≤ 100 ns
Nominal impulse discharge current (8/20 μs) line-earth	In 5 kA	20 kA
Nominal impulse discharge current (8/20 μs) line-line	In 2,5 kA	15 kA
Max. impulse discharge current (8/20 μs) line-line	Imax 8 kA	-
Max. impulse discharge current (8/20 μs) line-earth	Imax 15 kA	20 kA
Operating temperature range	TU -20 - +85 °C	-20 - +85 °C
Mounting	2x M3-screw (30mm)	2x M3-screw (30mm)
Type of connection	screw terminals	screw terminals
Max. conductor cross section	2,5 mm² flexible	-

#### Dimension

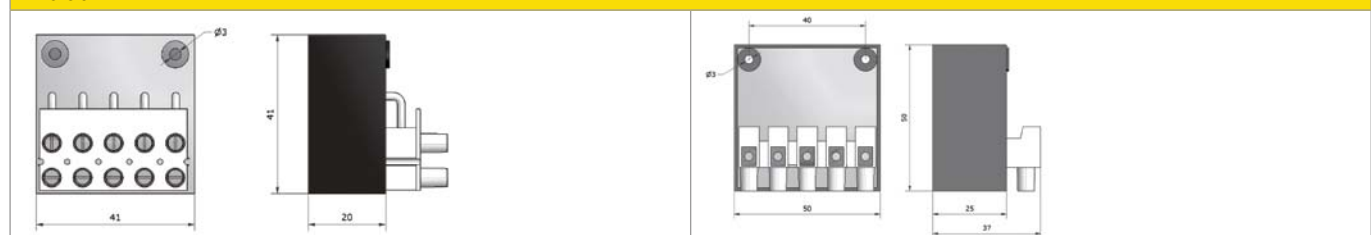



## SPD type 3 for AC power supplies

### EnerPro-T3/230 KM

Surge arrester for installation systems and terminal equipment with optical fault indication (LED).

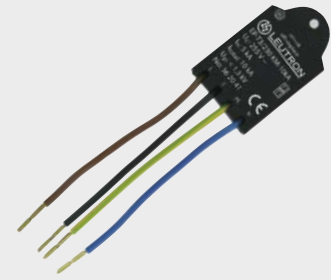
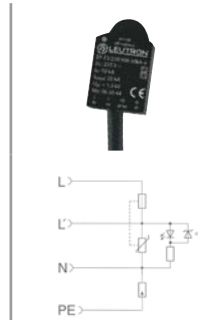
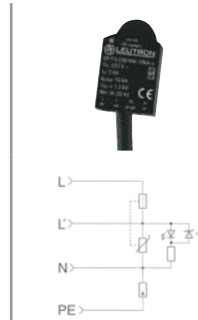
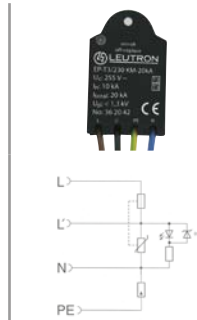
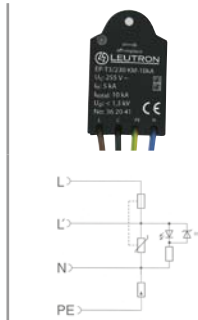
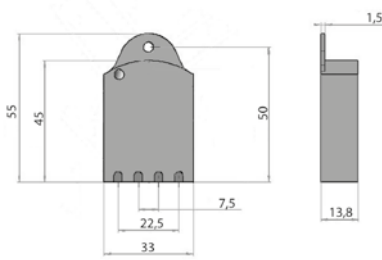

Image example

- Applicable at the LPZ transition point 2-3
- Test standard: IEC 61643-11 / EN 61643-11
- Protection against longitudinal and transverse voltages for loads up to 16 A
- Universal device for use in cable ducts and holder boxes
- Applicable für protection of LED illuminant
- Protection against humidity: encapsulated „v“
- EAC certification



#### Technical Data

Product name	EP-T3/230 KM-10kA	EP-T3/230 KM-20kA	EP-T3/230 KM-10kA-v	EP-T3/230 KM-20kA-v
Article-No.	36 20 41	36 20 42	36 20 43	36 20 44
IEC category	Type 3 / class III	Type 2 + 3 / class II + III	Type 3 / class III	Type 2 + 3 / class II + III
Nominal voltage AC	UN 230 V~	230 V~	230 V~	230 V~
Max. continuous operating voltage AC (50/60Hz)	Uc 255 V~	255 V~	255 V~	255 V~
Max. acceptable fuse or back-up fuse	16 A gG	16 A gG	16 A gG	16 A gG
Rated load current	IL 16 A	16 A	16 A	16 A
Protection level	Up ≤ 1,3 kV	≤ 1,3 kV	≤ 1,3 kV	≤ 1,3 kV
Combined surge	Uoc 10 kV	10 kV	10 kV	10 kV
Nominal impulse discharge current (8/20 μs)	In 5 kA	10 kA	5 kA	10 kA
Max. impulse discharge current (8/20 μs)	Imax 10 kA	20 kA	10 kA	20 kA
Operating temperature range	TU -15 - +60 °C	-15 - +60 °C	-15 - +60 °C	-15 - +60 °C
Degree of protection (IEC EN 60529)	IP 21	IP 21	IP 65	IP 65
Conductor length	90 mm	90 mm	200 mm	200 mm
Dimension (L x H x T)	55 x 33 x 12 mm	55 x 33 x 12 mm	55 x 33 x 13,8 mm	55 x 33 x 13,8 mm
Mounting on	under-floor systems, cable trays and device installation boxes		under-floor systems, cable trays and device installation boxes	

## SPD type 3 for AC power supplies

### EnerPro-T3/230 SDU

Two-pole surge arrester for the protection of electrical devices, for the retrofitting of 230 V flush-mounted boxes.

- Applicable at the LPZ transition point 2-3
- Test standard: IEC 61643-11 / EN 61643-11
- Valve arrester SPD (leakage-current free)
- With acoustic fault indication
- EAC certification

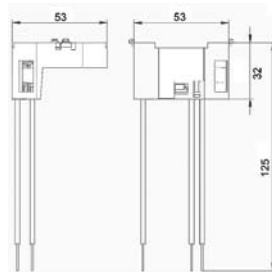
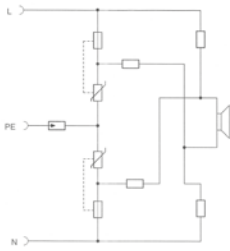

Technical Data	
<b>Product name</b>	<b>EP-T3/230 SDU</b>
Article-No.	36 20 40
IEC category	Type 3 / class III
Nominal voltage AC	UN 230 V~
Max. continuous operating voltage AC (50/60Hz)	Uc 255 V~
Rated load current	IL 16 A
Combined surge	Uoc 6 kV
Protection level L-N	Up ≤ 1,3 kV
Protection level L/N-PE	Up ≤ 1,5 kV
Max. acceptable fuse or back-up fuse	16 A gG
Response time L-N/L,N-PE	≤ 25 / ≤ 100 ns
Nominal impulse discharge current (8/20 μs)	In 3 kA
Max. impulse discharge current (8/20 μs)	Imax 8 kA
Operating temperature range	TU -20 - +60 °C
Type of connection	3 wire
Montageart	installation in 230V flush sockets
Degree of protection (IEC EN 60529)	IP 21

### CPS-F 230

Pluggable combined overvoltage protection for electrical and electronic devices with supply voltage of 230 V. Application for analogue and digital telephone lines, IT and networks. CPS is a pluggable combined overvoltage protection unit for electronic devices with 230 Vac voltage.

- Test standard: IEC 61643-11 / EN 61643-11
- Complete optical monitoring of conductor and arrester by LED
- Protection of Telephon/Fax/Modem with RJ11 jack
- Protection of ethernet or ISDN with RJ45 jack
- EAC certification



Technical Data	
<b>Product name</b>	<b>CPS-F 230/RJ45/RJ11</b>
Article-No.	32 50 45
IEC category	Type 3 / class III
Max. power	3680 W
Nominal voltage AC	UN 230 V~
Max. continuous operating voltage AC (50/60Hz)	Uc 255 V~
Rated load current	IL 16 A
Protection level	Up 1,5 kV
Nominal impulse discharge current (8/20 μs)	In 2,5 kA
Max. impulse discharge current (8/20 μs)	Imax 5 kA
Combined surge	Uoc 6 kV
Operating temperature range	TU 0 - +40 °C
Degree of protection (IEC EN 60529)	IP 20
connections	RJ45/RJ11
Max. continuous operating voltage DC	Uc 180 V=



### Surge Protection for new LED Lighting Systems

Many municipalities have already adapted to this situation and are using LED technology when installing new street lighting. (see also: „Kommunen im neuen Licht“, Technical University of Darmstadt, a study funded by the Federal Ministry of Education and Research, May 2013). Funding programmes encourage this transition.

However, it has been found that today's lighting systems cannot easily be replaced by LED technology. Technical design, processing, installation, maintenance and usage require a completely new approach to the new lighting systems.

Often, the planning process does not cover surge protection. A nearby lightning strike with surges of several thousand to ten thousand volts may cause over-voltage damages, that require the replacement of LED lamps and, thus, may burden municipal funds furthermore.

Surge arresters should preferably be placed in the lamp head close to the sensitive elements like control unit, ballast, driver electronics, printed circuit board carrying the LED lamps and optical sensors.

For already installed LED street lighting the light-

ning and surge protection can be added into the lamp head afterwards. In this case, an installation of surge arresters in the cable junction box at the stub of the lamppost is recommended. Additionally, the control cabinet has to be protected against surges.

A lightning current arresters of class I should be used for the power supply (see fig. 1).

Whereas, a lightning current arrester of class II provides the best protection for the control electronics inside the control cabinet (see fig. 1).

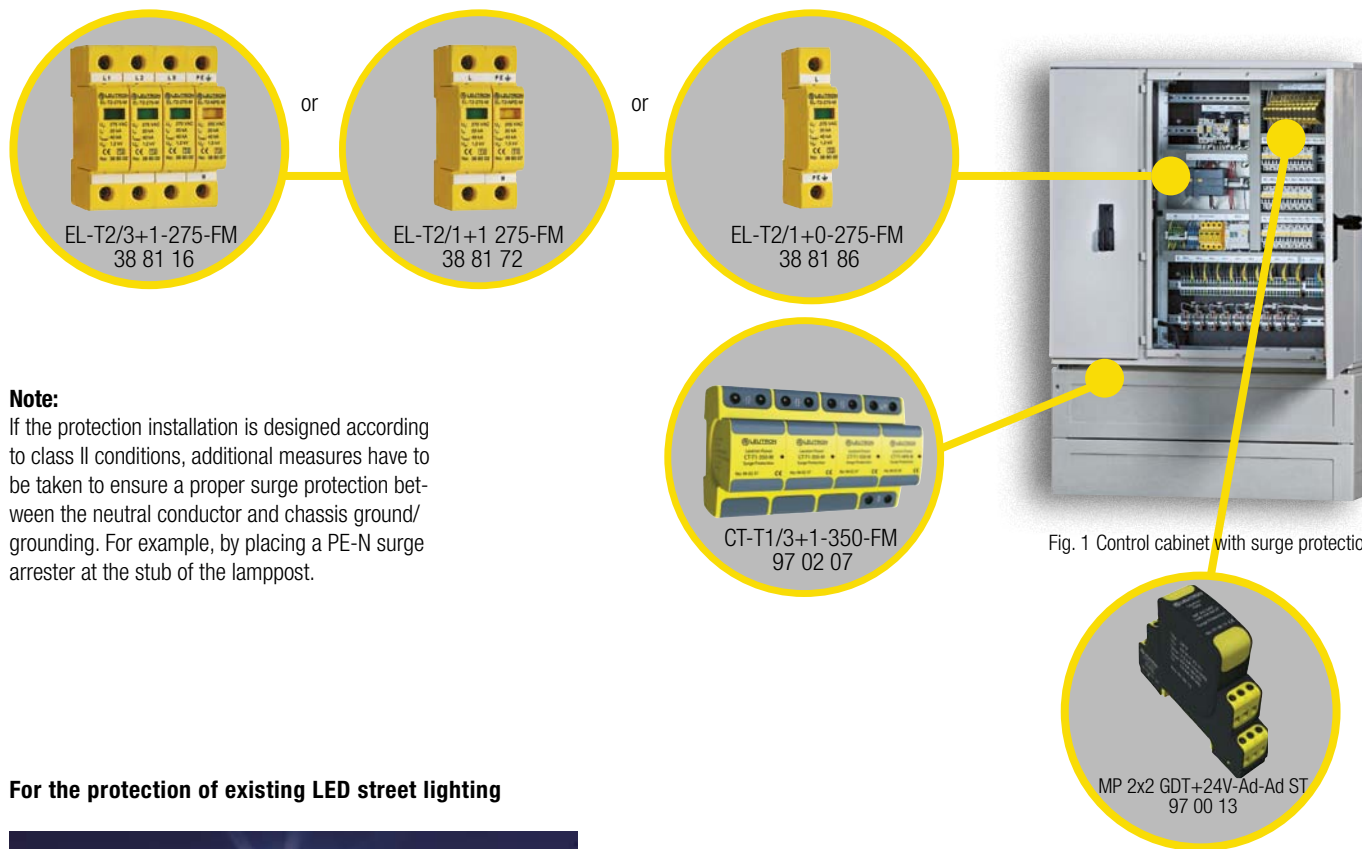

Fig. 1 Control cabinet with surge protection

### For the protection of existing LED street lighting

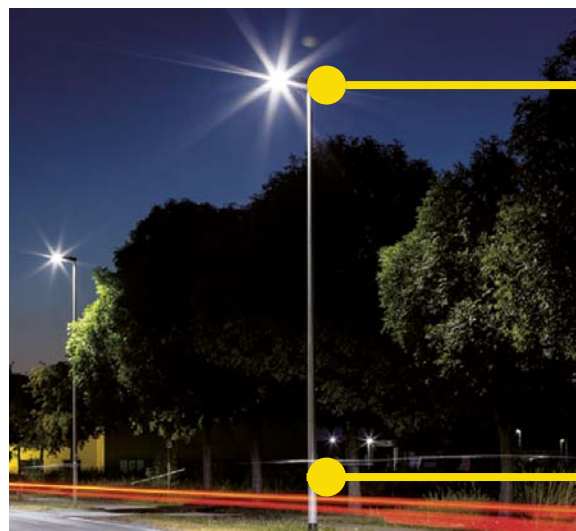
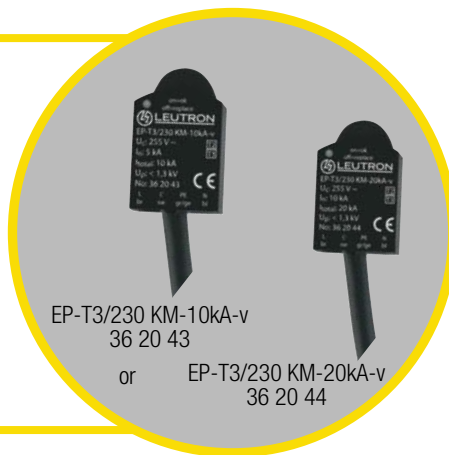

Fig. 2 LED street lighting (Source: TRILUX GmbH & Co. KG)



Protection of the electronic ballast





## DC Power Supply

### EnerPro V/100A-Tr

Surge voltage protector for equipment power supplies and installations up to 100 A and 48/60 Volt. A very low protection level allows the use as SPD class III.



image example

- High performance surge protector
- Valve arrester SPD (leakage-current free)
- Function control indication via LED
- Mounting on 35 mm DIN rail (EN 60715)
- Degree of protection according to IEC EN 60529: IP 20
- Remote signalling contact (Pk): break contact
- Inflammability class according to UL 94 V0
- Dimension (DIN 43880): 2 TE
- EAC certification

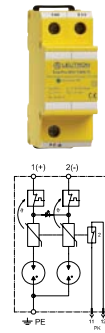
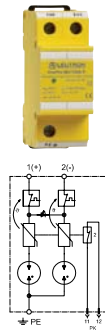
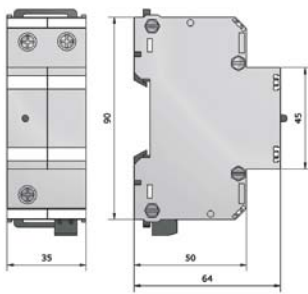

#### Technical Data

Product name	EnerPro 48V/100A-Tr/Pk	EnerPro 60V/100A-Tr/Pk
Article-No.	38 20 71	38 20 76
IEC category	Type 2 / class II	Type 2 / class II
Nominal voltage DC	UN 48 V=	60 V=
Nominal voltage AC	UN 34 V~	53 V~
Max. continuous operating voltage DC	Uc 60 V=	75 V=
Max. continuous operating voltage AC (50/60Hz)	Uc 42 V~	60 V~
Protection level at 1kV/μs (1, 2-PE)	Uas ≤ 0,2 kV	≤ 0,3 kV
Protection level at In (1, 2-PE)	Ures ≤ 0.3 kV	≤ 0,4 kV
Response time	tA < 25 ns	< 25 ns
Nominal discharge current (8/20 μs)	In 15 kA	15 kA
Max. impulse discharge current (8/20 μs)	Imax 30 kA	30 kA
Max. allowed fuse or back-up fuse	125 A gG	125 A gG
Max. conductor cross section	50mm <sup>2</sup> stranded/35mm <sup>2</sup> flexible	50mm <sup>2</sup> stranded/35mm <sup>2</sup> flexible
Operating temperature range	TU -40 - +80 °C	-40 - +80 °C
Recommended conductor cross section	25 mm <sup>2</sup>	25 mm <sup>2</sup>
Max. Locking torque terminals	4,0 Nm	4,0 Nm
Enclosure material / colour	Polycarbonate UL 94-V0 / yellow	Polycarbonate UL 94-V0 / yellow
Switching capacity	250 V/2 A	250 V/2 A
Max. conductor cross section Pk	1,5 mm <sup>2</sup>	1,5 mm <sup>2</sup>



### DC Power Supply with filter

#### EnerPro 6A/LED

Surge voltage arrester for electrical and electronic devices in looped-in wiring, with disconnection device without interruption of the power supply. A very low protection level allows the use as SPD class III.



image example

- Two-pole SPD for operating current up to 6 A
- Arrester status control display: LED green and red
- Mounting on 35 mm DIN rail (EN 60715)
- Degree of protection according to IEC EN 60529: IP 20
- Inflammability class according to UL 94 V0
- EAC certification
- With low-pass filter
- Dimension (DIN 43880): 3 TE

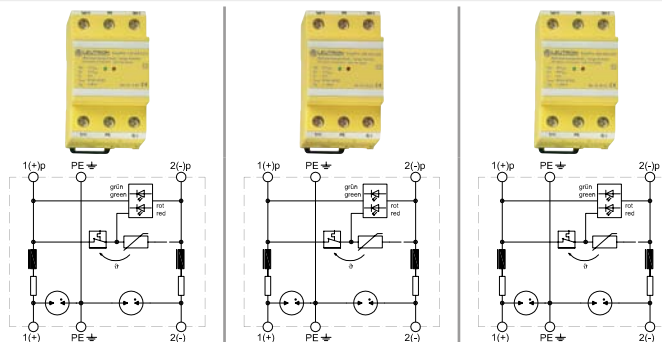
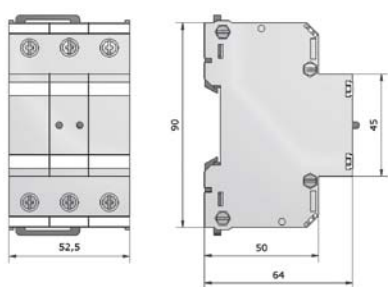

#### Technical Data

Product name		EnerPro 12V-6A/LED	EnerPro 24V-6A/LED	EnerPro 36V-6A/LED
Article-No.		24 12 02	24 24 02	24 36 02
IEC category		Type 2 / class II	Type 2 / class II	Type 2 / class II
Rated voltage DC (1-2/1p-2p)	UN	12 V=	24 V=	36 V=
Rated voltage AC (1-2/1p-2p)	UN	8 V~	17 V~	24 V~
Max. operating voltage DC (1-2/1p-2p)	Uc	15 V=	27 V=	40 V=
Max. operating voltage AC (1-2/1p-2p)	Uc	10 V~	20 V~	29 V~
Max. operating current	IL	6 A	6 A	6 A
Response time	tA	< 25 ns	< 25 ns	< 25 ns
Series inductance, typ.	L	20 µH	20 µH	20 µH
Protection level (line-earth)	Up	650 V	650 V	650 V
Protection level line-line at 1 kV/µs	Up	≤ 80 V	≤ 100 V	≤ 200 V
Short-circuit current extinguishing capacity line-line		≤ 6 A	≤ 6 A	≤ 6 A
Short-circuit current extinguishing capacity line-earth		≤ 1 A	≤ 1 A	≤ 1 A
Max. impulse discharge current (8/20 µs)	I <sub>max</sub>	40 kA	40 kA	40 kA
Critical discharge current (10/700 µs)		1000 A	1000 A	1000 A
Max. alternating discharge current (50 Hz/ 5x 0,5s)	I <sub>wn</sub>	50 A	50 A	50 A
Service life test current (500 x 10/700 µs)	i <sub>l</sub>	200 A	200 A	200 A
Max. current 50 Hz/0.5 s	I <sub>g</sub>	80 A	80 A	80 A
Operating temperature range	TU	-40 - +80 °C	-40 - +80 °C	-40 - +80 °C
Max. conductor cross section		50mm <sup>2</sup> stranded/35mm <sup>2</sup> flexible	50mm <sup>2</sup> stranded/35mm <sup>2</sup> flexible	50mm <sup>2</sup> stranded/35mm <sup>2</sup> flexible
Dimensions (L x W x H)		52,5 x 90 x 64 mm	52,5 x 90 x 64 mm	52,5 x 90 x 64 mm
Max. Locking torque terminals		4,0 Nm	4,0 Nm	4,0 Nm
Enclosure material / colour		Polycarbonate UL 94-V0 / yellow	Polycarbonate UL 94-V0 / yellow	Polycarbonate UL 94-V0 / yellow



## DC Power Supply with filter

### EnerPro 20A/LED

Two-pole SPD for operating current up to 20 A in looped-in wiring, with disconnection device without interruption of the power supply.  
A very low protection level allows the use as SPD class III.



image example

- Surge voltage protection for electrical and electronic devices
- Arrester status control display: LED green
- Mounting on 35 mm DIN rail (EN 60715)
- Degree of protection according to IEC EN 60529: IP 20
- Inflammability class according to UL 94 V0
- EAC certification
- With low-pass filter
- Dimension (DIN 43880): 3 TE

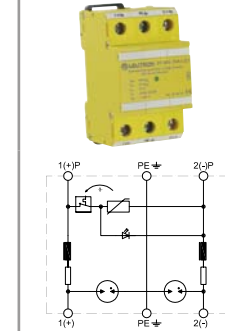
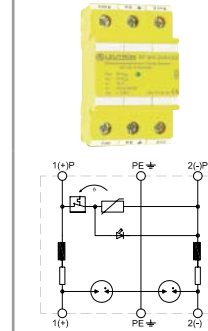
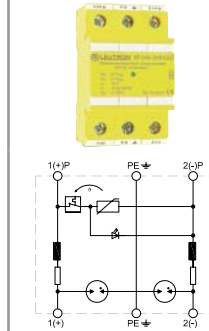
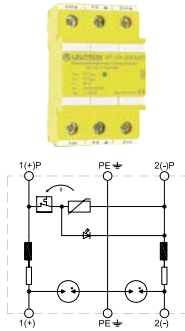
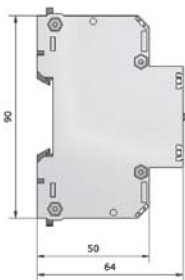

#### Technical Data

Product name		EP 12V-20A/LED	EP 24V-20A/LED	EP 36V-20A/LED	EP 48V-20A/LED
Article-No.		24 12 03	24 24 03	24 36 03	24 48 03
IEC category		Type 2 / class II	Type 2 / class II	Type 2 / class II	Type 2 / class II
Rated voltage DC (1-2 / 1p-2p)	UN	12 V=	24 V=	36 V=	48 V=
Rated voltage AC (1-2 / 1p-2p)	UN	8 V~	17 V~	24 V~	30 V~
Max. operating voltage DC (1-2 / 1p-2p)	Uc	15 V=	27 V=	40 V=	53 V=
Max. operating voltage AC (1-2/1p-2p)	Uc	10 V~	20 V~	29 V~	37 V~
Max. operating current	IL	20 A	20 A	20 A	20 A
Protection level line-line at 1 kV/μs and In	Up	≤ 80 V	≤ 100 V	≤ 200 V	≤ 300 V
Response time	tA	25 ns	25 ns	25 ns	25 ns
Short-circuit current extinguishing capacity line-line		≤ 6 A	≤ 6 A	≤ 6 A	≤ 6 A
Short-circuit current extinguishing capacity line-earth		≤ 1 A	≤ 1 A	≤ 1 A	≤ 1 A
Nominal impulse discharge current L1, L2-PE (8/20 μs)	In	20 kA	20 kA	20 kA	20 kA
Max. impulse discharge current L1, L2-PE (8/20 μs)	Imax	40 kA	40 kA	40 kA	40 kA
Max. impulse discharge current L1+L2-PE (8/20 μs)	Imax	80 kA	80 kA	80 kA	80 kA
Operating temperature range	TU	-40 - +80 °C	-40 - +80 °C	-40 - +80 °C	-40 - +80 °C
Max. conductor cross section		50mm <sup>2</sup> stranded/35mm <sup>2</sup> flexible	50mm <sup>2</sup> stranded/35mm <sup>2</sup> flexible	50mm <sup>2</sup> stranded/35mm <sup>2</sup> flexible	50mm <sup>2</sup> stranded/35mm <sup>2</sup> flexible
Max. Locking torque terminals		4,0 Nm	4,0 Nm	4,0 Nm	4,0 Nm
Dimensions (L x W x H)		64 x 90 x 52,5 mm	64 x 90 x 52,5 mm	64 x 90 x 52,5 mm	64 x 90 x 52,5 mm
Enclosure material / colour		Polycarbonate UL 94-V0 / yellow	Polycarbonate UL 94-V0 / yellow	Polycarbonate UL 94-V0 / yellow	Polycarbonate UL 94-V0 / yellow



### DC Power Supply with filter

#### EnerPro V-Tr

Two-pole SPD class II + III with gas discharge tubes (GDT) and suppressor diodes for operating currents up to 6 A.



image example

- Two-step protective circuit with integrated low-pass filter
  - High performance surge protector for operating voltage of 24 V up to 60 V DC
  - Mounting directly on mounting plate or on 35 mm DIN rail
- Degree of protection according to IEC EN 60529: IP 20
  - Inflammability class according to UL 94 V0
  - EAC certification
  - Dimension (DIN 43880): 1 TE

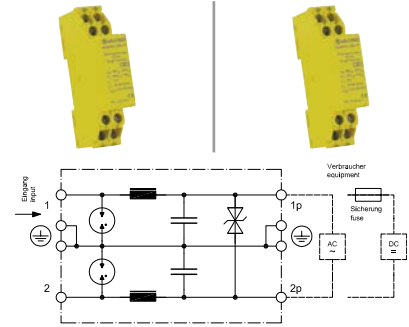
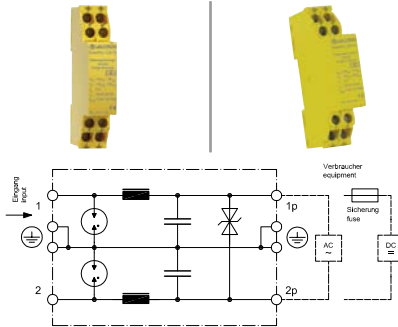
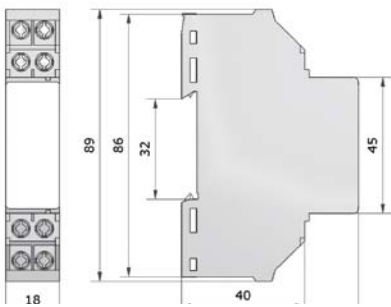

#### Technical Data

Product name	EnerPro 12V-Tr	EnerPro 24V-Tr	EnerPro 36V-Tr	EnerPro 48V-Tr
Article-No.	24 12 00	24 24 00	24 36 00	24 48 00
IEC category	Type 2 + 3 / class II + III	Type 2 + 3 / class II + III	Type 2 + 3 / class II + III	Type 2 + 3 / class II + III
Nominal voltage DC	UN 12 V=	24 V=	36 V=	48 V=
Nominal voltage AC	UN 8 V~	17 V~	24 V~	30 V~
Max. continuous operating voltage DC	Uc 15 V=	27 V=	40 V=	53 V=
Max. continuous operating voltage AC (50/60Hz)	Uc 10 V~	20 V~	29 V~	37 V~
Max. operating current	IL 6 A	6 A	6 A	6 A
Leakage current at Uc DC	≤ 5 µA	≤ 5 µA	≤ 5 µA	≤ 5 µA
DC resistance	R 27 Ω	27 Ω	27 Ω	27 Ω
Series inductance, typ.	L 20 µH	20 µH	20 µH	20 µH
Protection level line-earth at 1kV/µs and In	Up ≤ 800, typ. 650 V	≤ 800, typ. 650 V	≤ 800, typ. 650 V	≤ 800, typ. 650 V
Protection level line-line at 1 kV/µs and In	Up ≤ 20 / 27 V	≤ 37 / 55 V	≤ 55 / 85 V	≤ 85 / 110 V
Short-circuit current extinguishing capacity line-line	≤ 6 A	≤ 6 A	≤ 6 A	≤ 1.0 A
Short-circuit current extinguishing capacity line-earth	≤ 1 A	≤ 1 A	≤ 1 A	≤ 0,75 A
Lightning impulse current (10/350 µs)	Iimp 3 kA	3 kA	3 kA	3 kA
Nominal impulse discharge current (10 x 8/20 µs)	In 20 kA	20 kA	20 kA	20 kA
Service life test current (500 x 10/700 µs)	il 200 A	200 A	200 A	200 A
Critical discharge current (10/700 µs)	1000 A	1000 A	1.000 A	1000 A
Max. alternating discharge current (50 Hz/ 5x 0,5s)	50 A	50 A	50 A	50 A
Max. current 50 Hz/0.5 s	80 A	80 A	80 A	80 A
Operating temperature range	TU -25 - +85°C	-25 - +85°C	-25 - +85°C	-25 - +85°C
Max. conductor cross section	2.5 mm <sup>2</sup> single-wire / 1.5 mm <sup>2</sup> flexible with sleeve		2.5 mm <sup>2</sup> single-wire / 1.5 mm <sup>2</sup> flexible with sleeve	

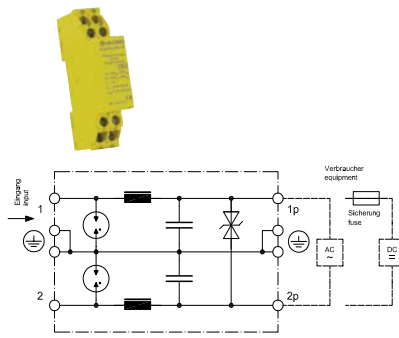

### Technical Data

Product name	EnerPro 60V-Tr	
Article-No.	24 60 00	
IEC category	Type 2 + 3 / class II + III	
Nominal voltage DC	UN	60 V=
Nominal voltage AC	UN	43 V~
Max. continuous operating voltage DC	Uc	85 V=
Max. continuous operating voltage AC (50/60Hz)	Uc	60 V~
Max. operating current	IL	6 A
Leakage current at Uc DC		≤ 5 μA
DC resistance	R	27 Ω
Series inductance, typ.	L	20 μH
Protection level line-earth at 1kV/μs and In	Up	≤ 800 , typ. 650 V
Protection level line-line at 1kV/μs and In	Up	≤ 95/125 V
Short-circuit current extinguishing capacity line-line		≤ 1 A
Short-circuit current extinguishing capacity line-earth		≤ 0,75 A
Lightning impulse current (10/350 μs)	limp	3 kA
Nominal impulse discharge current (10 x 8/20 μs)	In	20 kA
Service life test current (500 x 10/700 μs)	ii	200 A
Critical discharge current (10/700 μs)		1000 A
Max. alternating discharge current (50 Hz/ 5x 0,5s)		50 A
Max. current 50 Hz/0.5 s		80 A
Operating temperature range	TU	-25 - +85°C
Max. conductor cross section		2.5 mm <sup>2</sup> single-wire / 1.5 mm <sup>2</sup> flexible with sleeve

### Accessories DataPro and EnerPro

	Grounding bridge
Article-No.	17 00 80

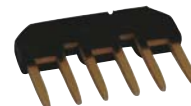

Bridge for optimal grounding. The cross section is 1,5 mm<sup>2</sup> per pin. The upper surface of the Grounding bridge is inslotated with plastics.



### EnerPro-T2-DC-16A

Compact and leakage-current free 1-pole surge arrester class II for nominal voltage DC of 220 V and rated load current of 16 A.

- Practical compact housing with minimum space requirement
- Remote signalling contact (FM): break contact
- Leakage current free
- Mounting on 35 mm DIN rail (EN 60715)
- Inflammability class according to UL 94 V0
- EAC certification

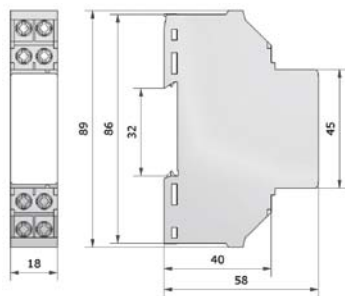
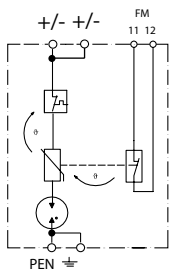

Technical Data	
<b>Product name</b>	<b>EP-T2/220VDC-16A-FM</b>
Article-No.	38 06 11
IEC category	Type 2 / class II
Nominal voltage DC	UN 220 V=
Max. continuous operating voltage DC	Uc 230 V=
Max. operating current	IL 16 A
Protection level at In	Up ≤ 1,5 kV
Response time	tA ≤ 100 ns
Nominal impulse discharge current (10 x 8/20 μs)	In 20 kA
Max. impulse discharge current (8/20 μs)	I <sub>max</sub> 25 kA
Max. allowed fuse or back-up fuse	16 A gG
Operating temperature range	TU -40 - +80°C
Min. conductor cross section at terminals	2.5 mm <sup>2</sup> single-wire / 1.5 mm <sup>2</sup> flexible with sleeve
Max. conductor cross section	2.5 mm <sup>2</sup> flexible / 4mm <sup>2</sup> solid
Enclosure material / colour	Polycarbonate UL 94-V0 / yellow
Degree of protection (IEC EN 60529)	IP 20
Switching capacity	250 V/2 A
Max. conductor cross section FM	1.5mm <sup>2</sup> solid/flexible



#### Accessories DataPro and EnerPro

Article-No.	Grounding bridge 17 00 80
-------------	------------------------------

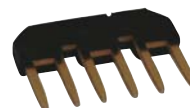

Bridge for optimal grounding. The cross section is 1,5 mm<sup>2</sup> per pin. The upper surface of the Grounding bridge is inslotated with plastics.



## Leutron protects the future

Because photovoltaic systems (among other things) are the future. Whether for new buildings or for renovations, for private residences or for office buildings: these systems are being installed on more and more roofs across Germany.

In addition to the modules, the photovoltaic system is also integrated into the building's

electrical systems, which are necessarily vulnerable to direct or indirect lightning strikes. Lightning strikes and power surges have serious consequences: aside from production losses, there are also high repair costs - Costs that Leutron can keep down.

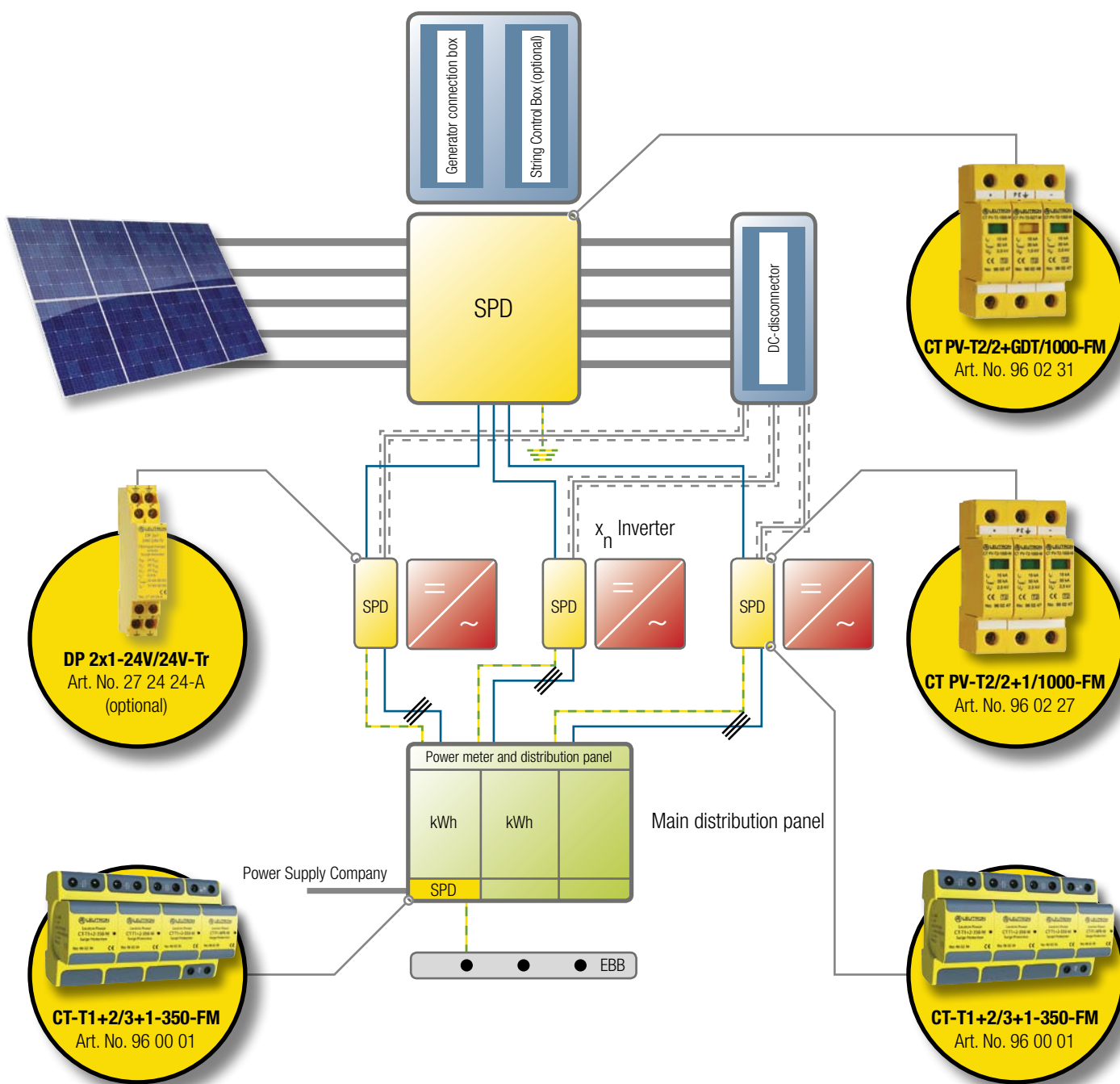



# SURGE PROTECTION FOR POWER SUPPLY SYSTEMS

## PROTECTION OF PV INSTALLATIONS

### PV SYSTEMS FOR THE HOME

There is one point to bear in mind when installing PV systems in private residences with lightning protection systems:

The lightning rods must be distanced from the PV modul in such way that lightning discharge are prevented, while casting as little shade as possible onto it on the other. The length and place of the air termination rod must also be chosen accordingly.

Specifications for adjustment of the protection area of the lightning rod are given in VDE 0185-305-3.

The space (s) between the photovoltaic system and the air termination rod should be greater than 0.5 m.

If it is not possible to leave a buffer space, then a direct electroconductive connection must be installed between the external lightning protection system and the PV module frame.

The purpose of this is to prevent lightning currents from flowing through the module frame construction. Thus, the electrical connection between the air termination rod and the frame construction is made on one side only, preferably on the side of the outgoing lines from the external lightning protection.

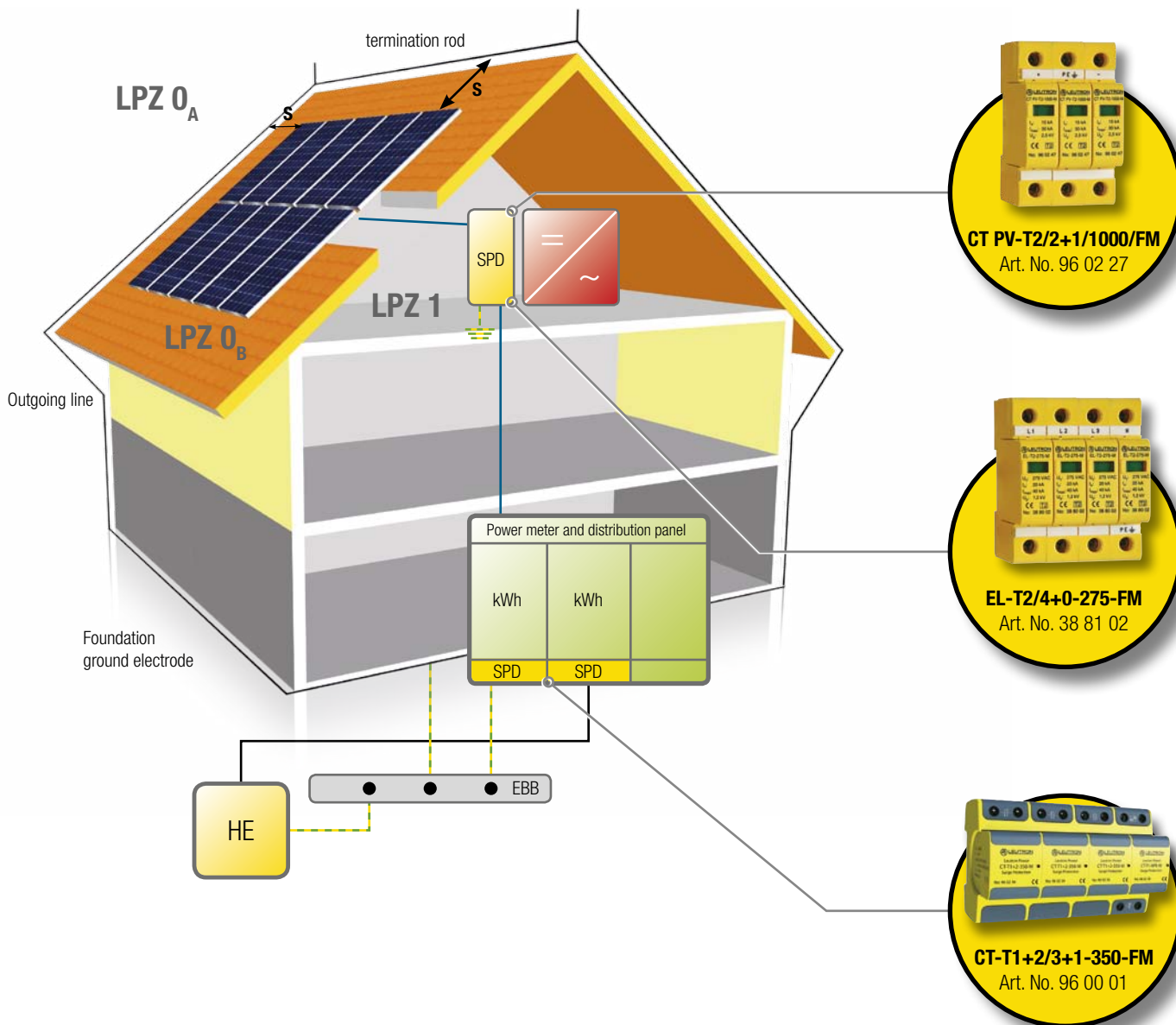



### LEUTRON PROTECTS PHOTOVOLTAIC SYSTEMS UP TO 1000 V DC

When applying surge protection devices (SPDs) in PV installations some specifics have to be considered. In contrast to the application of SPDs ac systems, PV installations contain a dc generator circuit with specific features. These specific features have an influence on the design of the protection system, and the SPDs have to be selected accordingly.

The SPDs for PV installations have to be laid out to fit the maximum no-load voltage ( $U_{OC,STC}$  = voltage of the no-load circuit at standard test conditions) of the solar generator as well as for a maximum availability and security of the PV installation.

Photovoltaic is an essential pillar of energy generation in the area of renewable, respectively regenerative energies. This does not only apply to Germany but to important export markets like Southern Europe and North America as well.

The standard DIN VDE 0100 (VDE 0100) part 712 [1] for the erection of PV installations exists since June 2006. This standard is harmonized on a European level, i. e. it is a HD document.

Since its transitional period expired on 1st May 2008 the standard is effective and has to be applied. The standard holds instructions for surge-voltage protection devices and lightning protection.

A surge voltage protection is not explicitly required, but it is recommended (see figure 1). Likewise, the standard points out that when applying a lightning protection the PV installation has to be protected by an insulated air terminal considering the separation distance.

#### External Lightning Protection

Due to their large-area setup and often exposed location PV installations are especially prone to atmospheric discharges like lightning. We have to distinguish between direct lightning impacts and indirect effects of inductive and capacitive character.

On the one hand, the necessity of lightning protection results from the requirements of the

standard and on the other hand it is defined by the application itself, i. e. if it is an installation on a building or in the field.

Installations on buildings can be divided into installations on buildings with an existing lightning protection system, e. g. public buildings, or those without one, e. g. barn roofs.

Due to their large modules, field installations have a great potential risk of lightning strokes as well. In this case an external lightning protection is advisable to prevent direct lightning strokes anyway.

The same applies to closed metal housings. With cables and metal housings the earthing has to be implemented on both sides. Hence, the generator main line (dc side) lies in an LPZ 1 (lightning protection zone), which allows for an SPD of type 2. Otherwise a type 1 SPD would be necessary.

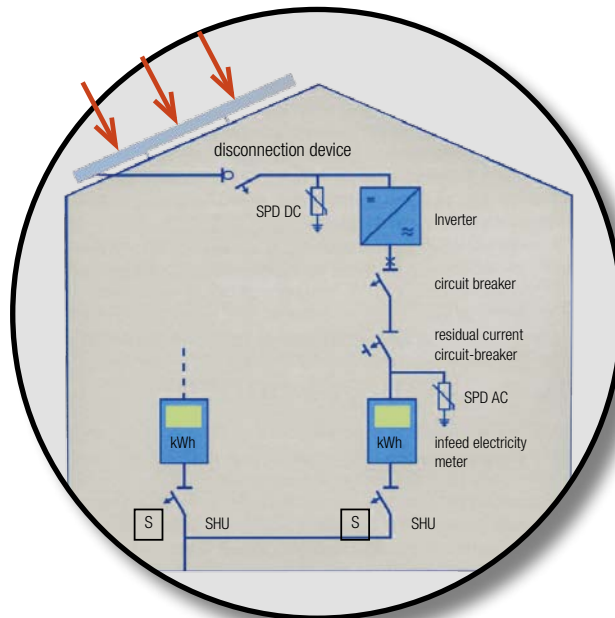

Figure 1: Extract from DIN VDE 0100-712, exemplary

Corresponding notes are given in DIN EN 62305-3 (VDE 0185-305-3) supplement 2 (dimensioning according to class of protection and lightning protection level LPL III), as well as in the VdS directive 2010 (for PV installation > 10 kW a lightning protection is necessary).

Additionally measures for surge protection are demanded. Thus, the PV generator is to be protected preferably by a separate air termination. However, if a direct connection to the PV generator can not be avoided, e. g., if it is not possible to maintain the separation distance, the effect of partial lightning currents must be considered.

In order to minimize induced surges only shielded generator main lines should be applied. A shield with a sufficient cross section (minimum of 16 mm<sup>2</sup> Cu) can be used additionally to divert partial lightning currents.

#### Application and correct layout of Surge Protective Devices

The application and design of SPDs in low-voltage installations can be considered as a standard solution on the inverter side, while their application and proper dimensioning on the side of the dc PV generator still is a challenge.

Firstly, the PV generator has some specifics, and secondly, the SPD is placed in a dc circuit. Conventional SPDs are typically designed for ac systems, and not for dc systems.

For several years now appropriate standards exist, which can be transferred to dc applications in principle. However, in the past, relatively low PV system voltages were used, whereas nowadays they can reach about 1000 V dc at the no-load PV circuit.

Such high dc voltages of the system must be controlled by appropriate SPDs.



# SURGE PROTECTION FOR POWER SUPPLY SYSTEMS

## PROTECTION OF PV INSTALLATIONS

The locations where to install SPDs in PV systems in a technically wise and reasonable way depend on the type of the PV system, its concept and its spatial dimensions. Figures 2 and 3 illustrate the fundamental difference:

1. A building with an external lightning protection installation and a PV generator mounted on the roof (building installation).
2. A large-area PV generator (field installation) equipped with an external lightning protection installation as well.

In the first case only the dc input of the inverter is protected due to the short cable lengths, whilst in the second case SPDs are placed inside the connection box of the solar generator (to protect the PV modules) as well as at the dc input of the inverter (to protect the inverter).

If the cable length between the PV generator and the inverter exceeds the distance of 10 m SPDs should be placed close to the PV generator and near the inverter, too. The AC side, i.e. the output side of the inverter and the system infeed point,

has to be protected by SPD type 2 at the inverter output as a standard and – at building installations with external lightning protection at the system infeed – by a SPD type 1.

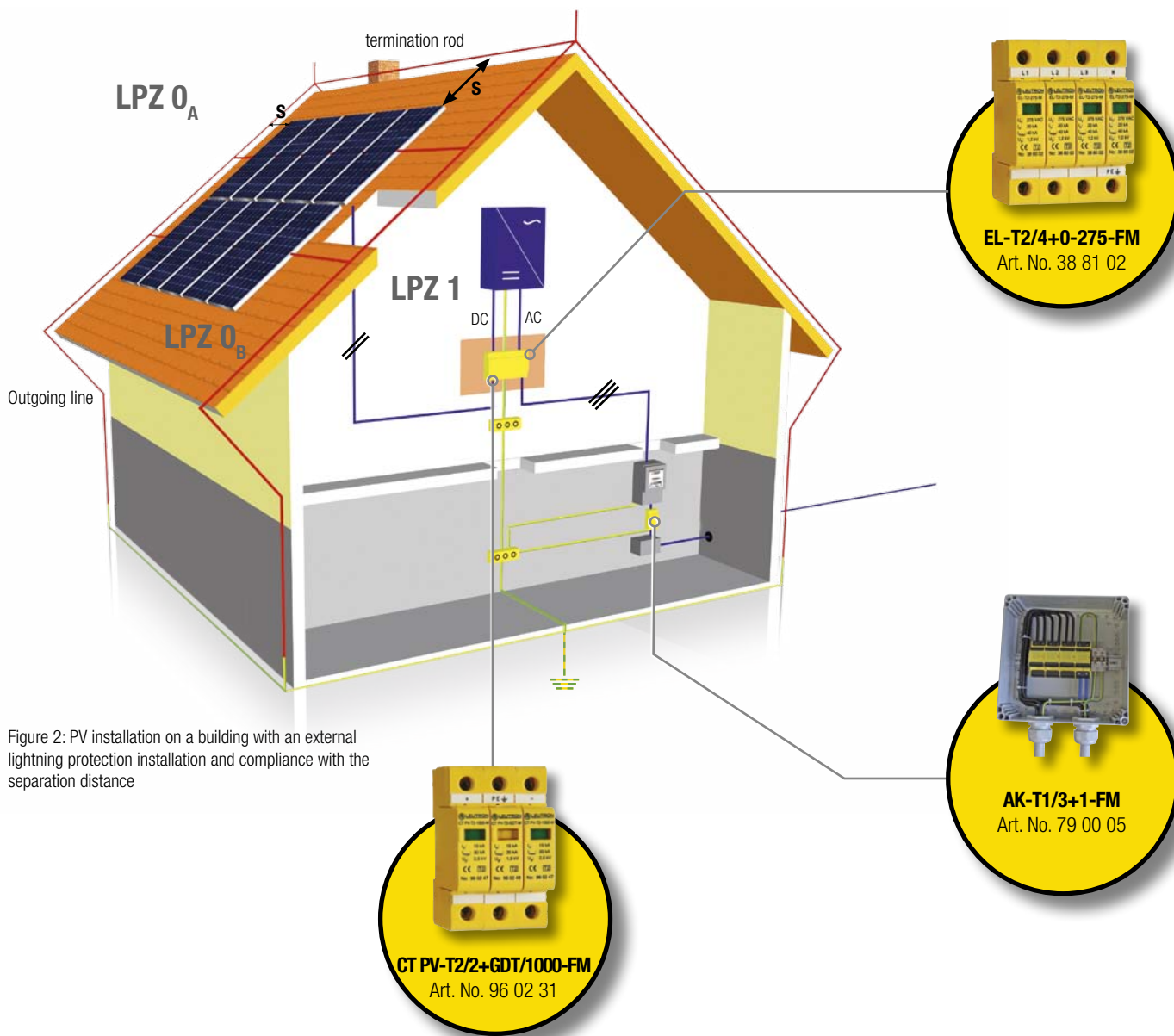

Figure 2: PV installation on a building with an external lightning protection installation and compliance with the separation distance



## LEUTRON PROTECTS PHOTOVOLTAIC SYSTEMS UP TO 1000 V DC

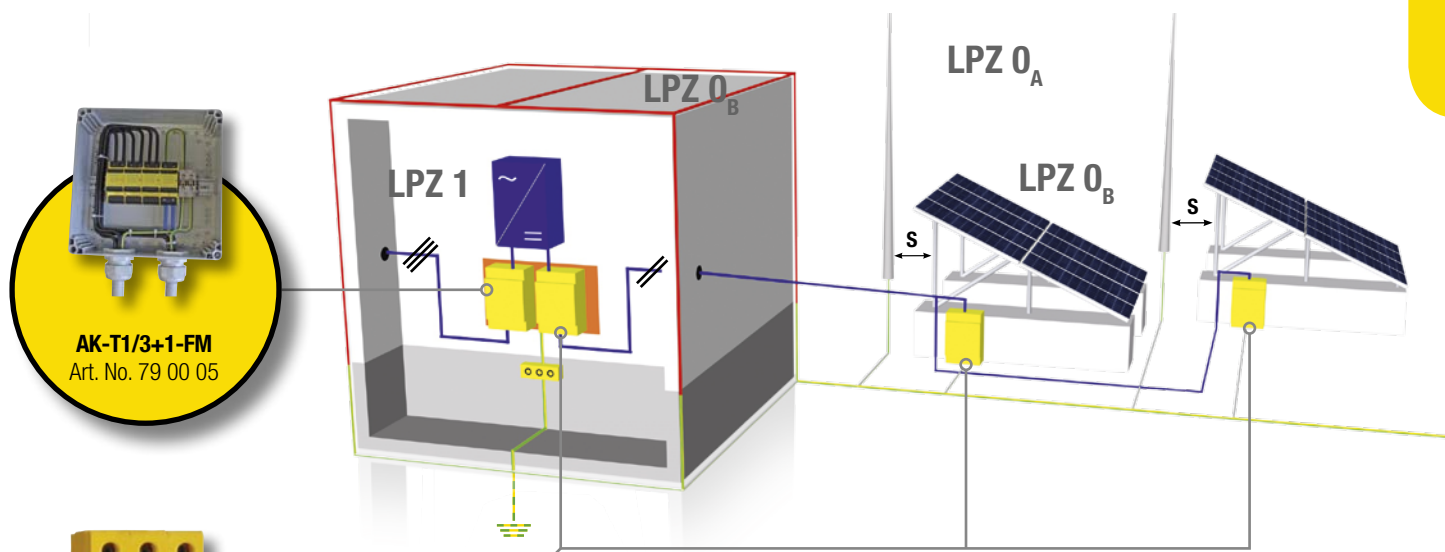
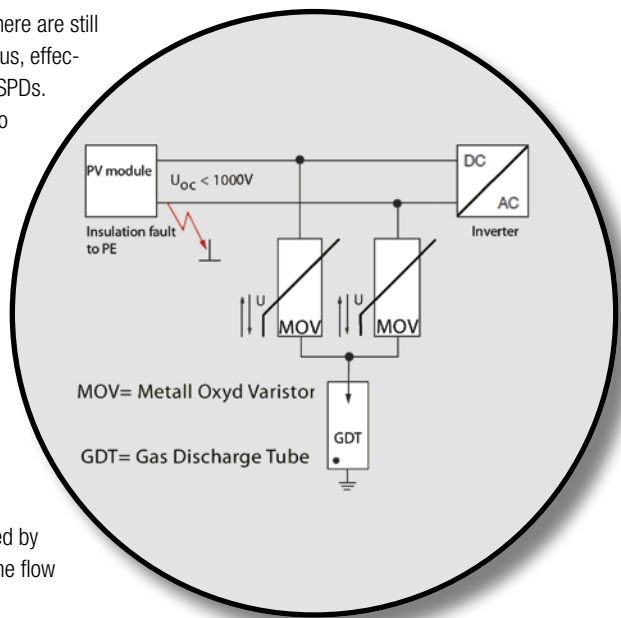
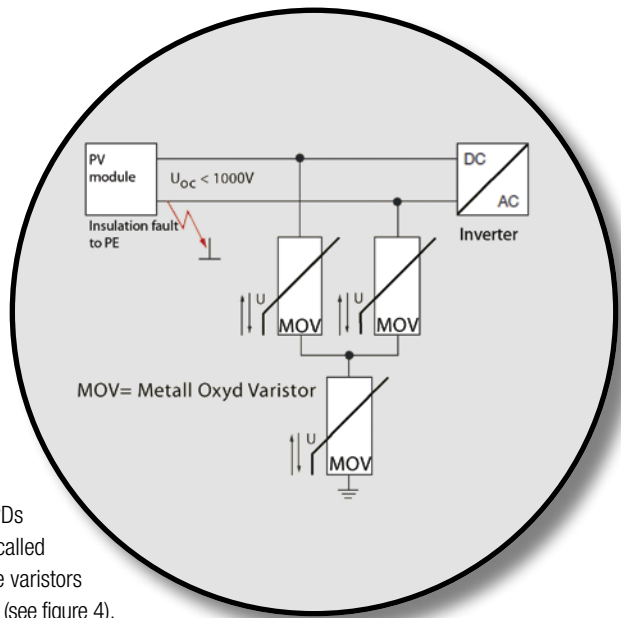

Fig. 3 (top): Field installation with an external lightning protection system, length of line between PV modules and inverter is longer than ten meter.

Fig. 4 (right): Y-connection with three varistors

Fig. 5 (bottom): Y-connection with two varistors and a spark gap



### Specifics on the side of dc solar power generator

Until now, SPDs that had been designed for normal supply voltages were used at the dc side to protect both L+ and L- against ground potential. These SPDs were laid out to at least 50% of the maximum no-load voltage of the PV generator.

After years of usage an insulation fault may occur in the PV generator. Due to this error the full voltage of the PV generator would apply to the SPD at the healthy pole, thus, causing an overload. When stressed with permanent high voltages SPDs with metal oxide varistors may break or trigger the disconnection device.

In the worst case, a fire hazard caused by a stationary arc can not totally be excluded when the disconnection device is activated, especially in PV installations with high system voltages. Even an upstream over-current protection (fuse) presents no solution, since the short-circuit current of the PV generator is only insignificantly higher than the rated current. Today, PV installations with system voltages of about 1000 V dc are more and more in use, to

minimize the power losses as much as possible. In order to adapt the SPDs to system voltages that high the so called Y-connection which consists of three varistors proved itself useful, and is established (see figure 4).

Even in case of an insulation error there are still two varistors connected in series, thus, effectively preventing an overload of the SPDs. Nevertheless, also in this case the so called leakage current flow through the varistors. The probability of increased leakage currents rises with the age of the varistors and with numerous exposures to surge voltages. In the worst case, these increased leakage currents may cause a fire due to the absence of any dc switching capacity. Subsequently, two things have to be taken into account: the high permanent voltage at the SPD, e. g. caused by an error at the PV installation, and the flow



# SURGE PROTECTION FOR POWER SUPPLY SYSTEMS

## PROTECTION OF PV INSTALLATIONS

of a high leakage current, e.g. due to frequent exposure to surge voltages.

The solution is provided by an Y-connection consisting of two varistors and a spark gap against ground potential (figure 5). The Y-connection prevents a too high permanent voltage at the SPD in case an insulation fault occurs in the PV circuit, and the spark gap itself impedes the flow of a leakage current. In other words, in case of

an insulation fault the spark gap prevents the disconnection device to be triggered.

Actually, the series connection of a metal oxide varistor and a spark gap (a gas discharge tube in this case) is nothing new – in memory of the old-established valve arrester. The single difference is the application in a dc circuit.

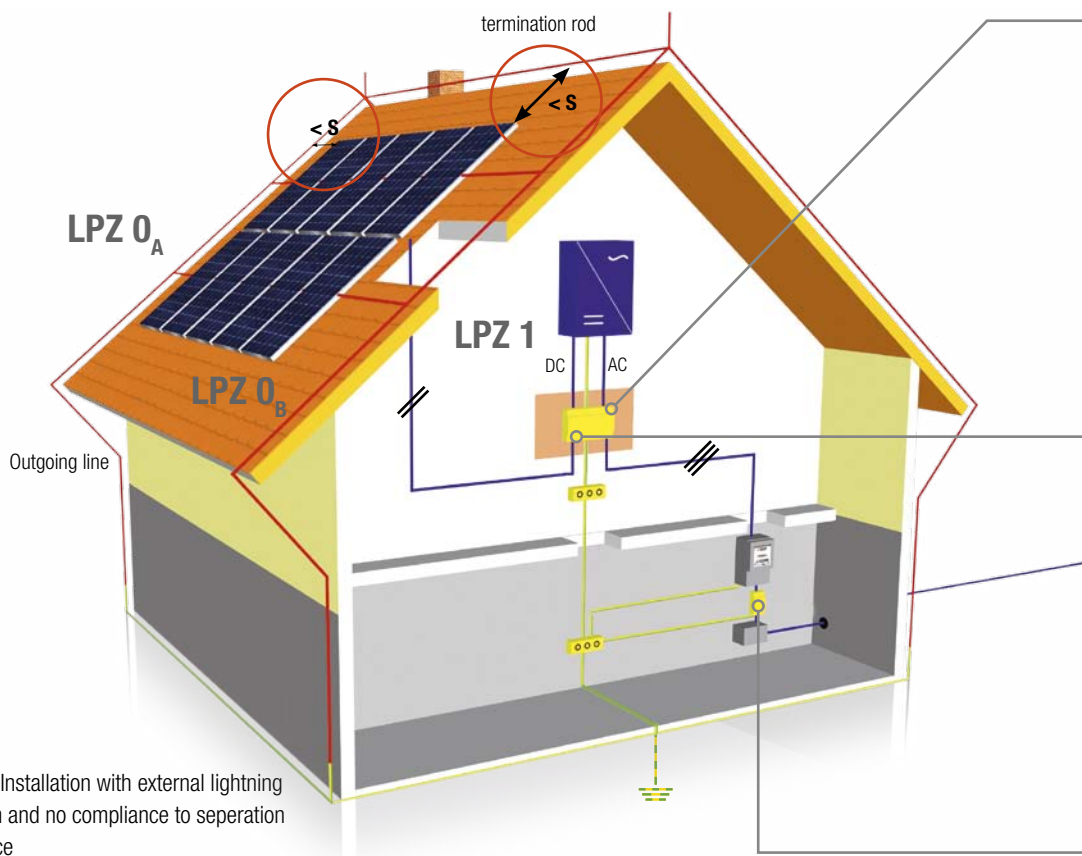

Fig. 6: Installation with external lightning system and no compliance to separation distance

**EL-T2/4+0-275-FM**  
Art. No. 38 81 02

**PP PV 1000/FM**  
Art. No. 37 44 03

**AK-T1/3+1-FM**  
Art. No. 79 00 05

### Application of lightning current arrester type 1

The application of type 1 SPDs on the dc side of the PV systems is recommended when an external lightning protection system is installed and the necessary separation distance between the lightning protection system and parts of the PV generator can not be kept. (cf. fig. 6).

It is advisable to use SPD type 1 on dc site of PV power supply systems if

- an external lightning protection is realized and
- the required separation distance to elements of the PV power supply systems is not given

The lightning impulse current capability  $I_{imp}$  per pole of the SPD is selected according to DIN EN 62305-1. The lightning impulse current capability  $I_{imp}$  of the SPD should be at least 10 kA (10/350  $\mu$ s) for each active line.

This normative minimum requirements for the type 1 SPDs is entirely fulfilled by the newly developed dc type 1 and 2 combined arresters (T1 + T2). Leutron's SPDs PP PV 800 and PP PV 1000 type 1 combined arresters (cf. fig. 6) are designed for  $U_{OC\ STC}$  voltages up to 800 V dc respectively 1000 V dc at  $I_{imp}$  12.5 kA (waveform 10/350  $\mu$ s) per pole and therefore for the actual requirements more than sufficiently.

The control is done via special thermal fuses to avoid fire hazard in case of overload. An integrated status display (LED) indicates the actual operation mode. An overload status can also be indicated via an optional remote contact.

All surge protection devices on the dc side (type 1 + 2) have to be selected in a way that in case of a short circuit they are able to transit into a safe mode and to avoid the risk of fire hazard due to an overload or an electric arc.

An overview supporting the SPD selection for PV supply systems is shown in fig. 7.



### SELECTION OF SPD FOR PV SUPPLY SYSTEMS

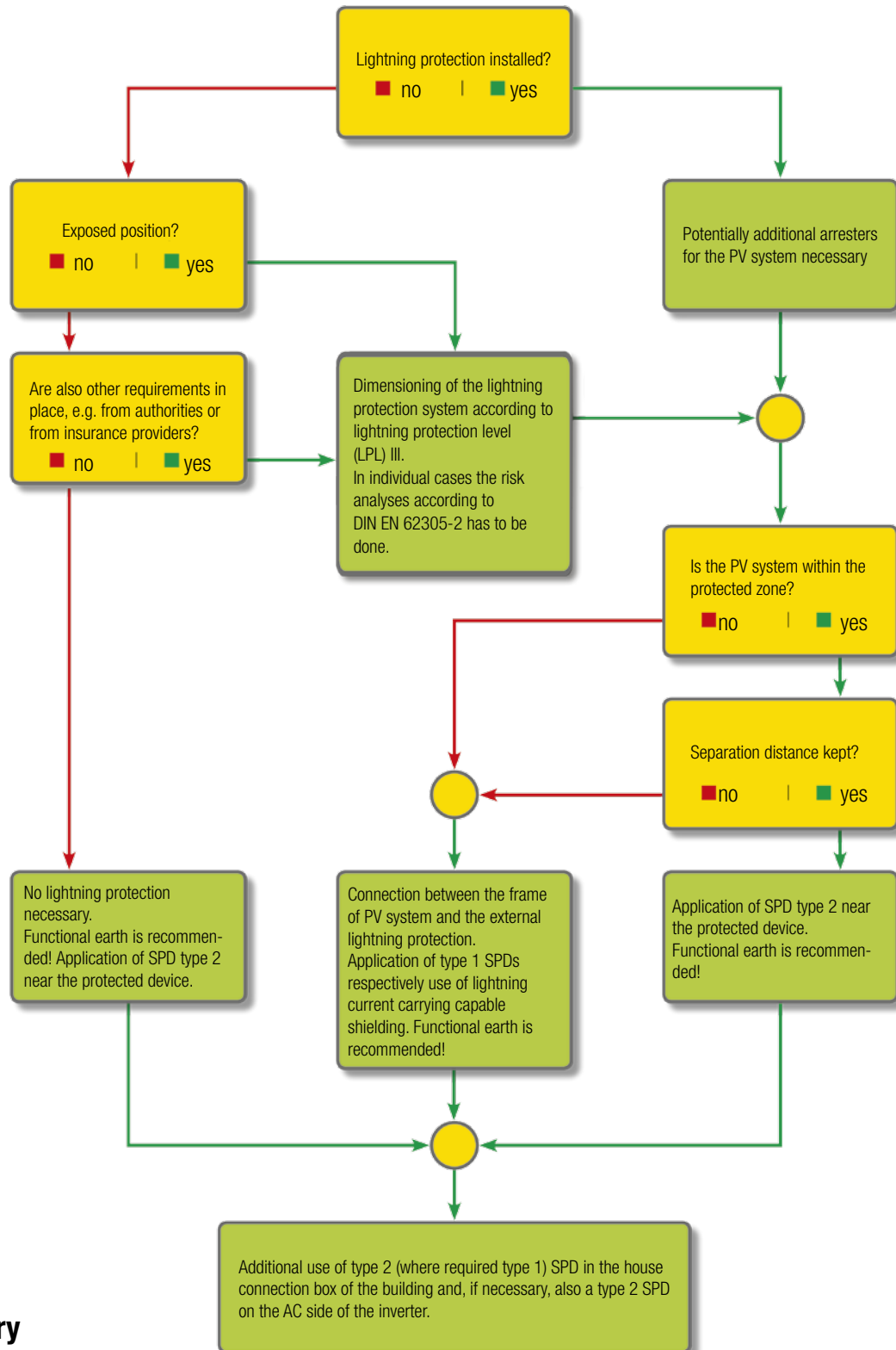

### Summary

- Installation of PV module according to risk analysis (VDE 0185-3-4)
- Shielding of primary generator line
- Installation of combined arrester
- Installation of combined arrester after entry building point
- Set-up of suitable protection units

Fig. 7: Flow chart for selecting SPDs in PV supply systems according to DIN EN 62305-3 supplemental sheet 5



### Surge arresters for Photovoltaic Installations

#### PowerPro PV

When applied in PV installations, these devices are placed inside the connection box of the solar generator and on the DC side of the inverter.



image example

- Two-pole combined lightning current and surge arrester DC class I and II
- Applicable at the LPZ transition point OA-1 and higher
- Test standard: IEC 61643-11 / EN 61643-11
- Mounting on 35 mm DIN rail (EN 60715)
- Space required for installation: 36 mm / 54 mm
- Remote signalling contact (FM): break contact
- Inflammability class according to UL 94 V0
- EAC certification

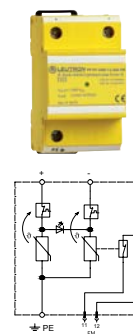
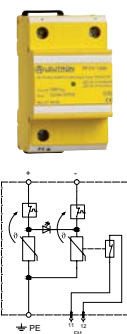
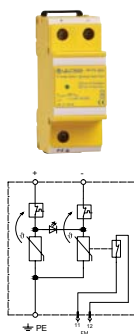
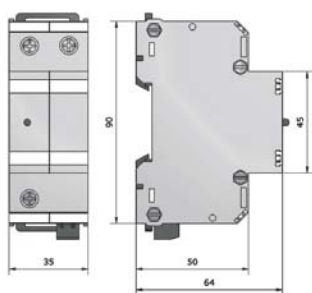

#### Technical Data

Product name	PP PV 800/FM	PP PV 1000/FM	PP PV 1000-12,5kA-FM
Article-No.	37 44 01	37 44 03	37 44 05
IEC category	Type 1 + 2 / class I+II	Type 1 + 2 / class I+II	Type 1 + 2 / class I+II
PV voltage	UocSTC 800 V=	1000 V=	1000 V=
Max. continuous operating voltage DC	Uc 850 V=	1100 V=	1100 V=
Protection level at In	Up ≤ 2,2 kV	≤ 4,2 kV	≤ 4,2 kV
Protection level at 5 kA	Up ≤ 1,8 kV	≤ 3,5 kV	≤ 3,5 kV
Response time	tA ≤ 25 ns	≤ 25 ns	≤ 25 ns
Lightning impulse current (10/350 μs) per pole	Iimp 12,5 kA	12,5 kA	6 kA
Max. impulse discharge current (8/20 μs)	Imax 40 kA	40 kA	20 kA
Operating temperature range	TU -40 - +80 °C	-40 - +80 °C	-40 - +80 °C
Min. conductor cross section at terminals	10 mm <sup>2</sup>	10 mm <sup>2</sup>	10 mm <sup>2</sup>
Max. conductor cross section	35mm <sup>2</sup> stranded/25mm <sup>2</sup> flexible	35mm <sup>2</sup> stranded/25mm <sup>2</sup> flexible	35mm <sup>2</sup> stranded/25mm <sup>2</sup> flexible
Max. locking torque terminals	4,0 Nm	4,0 Nm	4,0 Nm
Enclosure material / colour	Polycarbonate UL 94-V0 / yellow	Polycarbonate UL 94-V0 / yellow	Polycarbonate UL 94-V0 / yellow
Degree of protection (IEC EN 60529)	IP 20	IP 20	IP 20
Dimension (DIN 43880)	2 TE	3 TE	3 TE
Switching capacity	250 V/2 A	250 V/2 A	250 V/2 A
Max. conductor cross section FM	1,5 mm <sup>2</sup>	1,5 mm <sup>2</sup>	1,5 mm <sup>2</sup>



## Surge arresters for Photovoltaic Installations

### CT PV-T2

Fully pluggable surge protective arrester for the use in photovoltaic applications. Suitable fuse-free earthed photovoltaic applications with system voltages up to 600 or 1000 Volt DC.



image example

- Applicable at the boundaries LPZ 0B - 1 and higher
- Test standard: IEC 61643-11 / EN 61643-11
- Vibration test standard: DIN EN 60068-2-6, IEC 60068-2-6
- Shock test standard: DIN EN 60068-2-27, IEC 60068-2-27
- Mounting on 35 mm DIN rail (EN 60715)
- Degree of protection according to IEC EN 60529: IP 20
- Inflammability class according to UL 97 V0
- EAC certification
- Space required for installation: 36 mm / 54 mm
- Remote signalling contact (FM): changeover contact
- 2 + GDT is leakage current-free

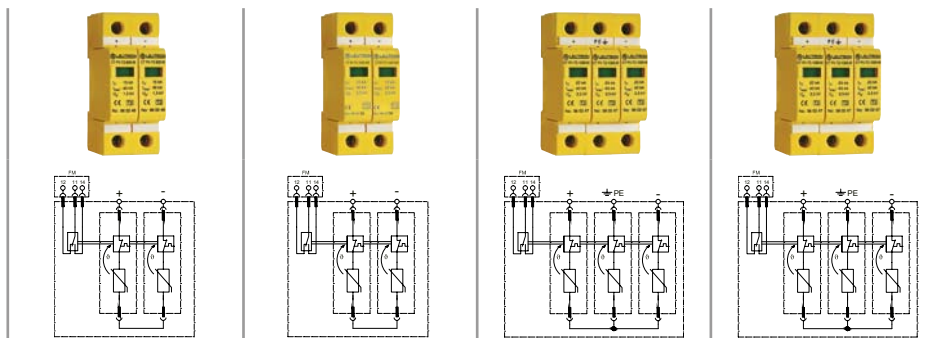

#### Technical Data

Product name	CT PV-T2/2-0/600-FM	CT PV-T2/2-0/1000-FM	CT PV-T2/2+1/600-FM	CT PV-T2/2+1/1000-FM
Article-No.	96 02 21	96 02 23	96 02 25	96 02 27
IEC category	Type 2 / class II	Type 2 / class II	Type 2 / class II	Type 2 / class II
Open-circuit voltage	UOC max. ≤ 600 V=	≤ 1000 V=	≤ 600 V=	≤ 1000 V=
Max. continuous operating voltage DC	Uc 600 V=	1000 V=	600 V=	1000 V=
Max. short-circuit current	ISC max. tbd.	tbd.	tbd.	tbd.
Nominal discharge current (8/20 μs)	In 20 kA	20 kA	20 kA	20 kA
Max. impulse discharge current (8/20 μs)	Imax 40 kA	40 kA	40 kA	40 kA
Protection level L+-L-	Up 3,0 kV	5,0 kV	3,0 kV	5 kV
Operating temperature range	TU -40 - +80 °C	-40 - +80 °C	-40 - +80 °C	-40 - +80 °C
Min. conductor cross section at terminals	1.5mm <sup>2</sup> solid/flexible	1.5mm <sup>2</sup> solid/flexible	1.5mm <sup>2</sup> solid/flexible	1.5mm <sup>2</sup> solid/flexible
Max. conductor cross section	35mm <sup>2</sup> stranded/25mm <sup>2</sup> flexible	35mm <sup>2</sup> stranded/25mm <sup>2</sup> flexible	35mm <sup>2</sup> stranded/25mm <sup>2</sup> flexible	35mm <sup>2</sup> stranded/25mm <sup>2</sup> flexible
Dimension (DIN 43880)	2 TE	2 TE	3 TE	3 TE
Max. operating voltage remote contact FM	250 V AC/125 V DC	250 V AC/125 V DC	250 V/2 A	250 V/2 A
Max. operating current FM	1 A AC/200 mA DC	1 A AC/200 mA DC	1 A AC/200 mA DC	1 A AC/200 mA DC
Max. conductor cross section FM	1,5 mm <sup>2</sup>	1,5 mm <sup>2</sup>	1,5 mm <sup>2</sup>	1,5 mm <sup>2</sup>



# SURGE PROTECTION FOR POWER SUPPLY SYSTEMS

## PROTECTION OF PV INSTALLATIONS

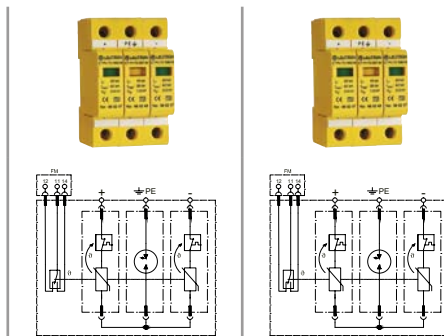

### Technical Data

Product name	CT PV-T2/2+GDT/600-FM	CT PV-T2/2+GDT/1000-FM
Article-No.	96 02 29	96 02 31
IEC category	Type 2 / class II	Type 2 / class II
Open-circuit voltage UOC max.	≤ 600 V=	≤ 1000 V=
Max. continuous operating voltage DC Uc	600 V=	1000 V=
Max. short-circuit current ISC max.	tbd.	tbd.
Nominal discharge current (8/20 μs) In	20 kA	20 kA
Max. impulse discharge current (8/20 μs) Imax	40 kA	40 kA
Protection level L+-L- Up	3 kV	5 kV
Protection level L+/L- -PE Up	3 kV	3 kV
Operating temperature range TU	-40 - +80 °C	-40 - +80 °C
Min. conductor cross section at terminals	1.5mm <sup>2</sup> solid/flexible	1.5mm <sup>2</sup> solid/flexible
Max. conductor cross section	35mm <sup>2</sup> stranded/25mm <sup>2</sup> flexible	35mm <sup>2</sup> stranded/25mm <sup>2</sup> flexible
Dimension (DIN 43880)	3 TE	3 TE
Max. operating voltage remote contact FM	250 V AC/125 V DC	250 V AC/125 V DC
Max. operating current FM	1 A AC/200 mA DC	1 A AC/200 mA DC
Max. conductor cross section FM	1,5 mm <sup>2</sup>	1,5 mm <sup>2</sup>

### Dimensions

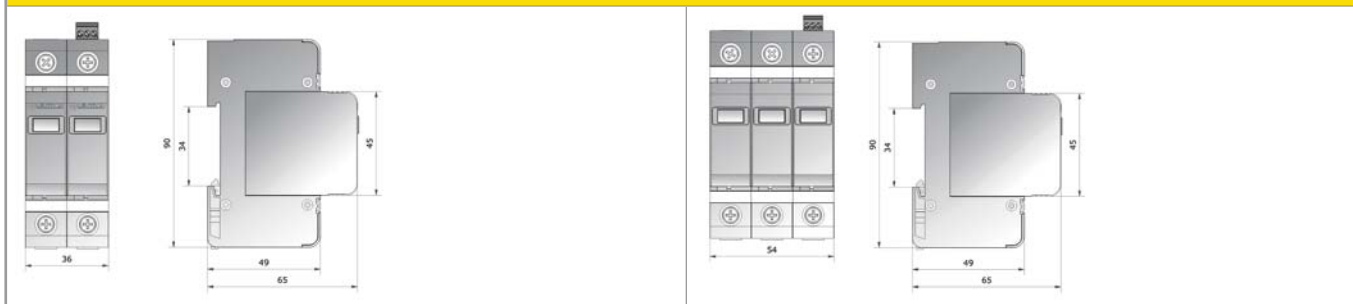

### Accessories

Article-No.	CT PV-T2-600-M	CT PV-T2-1000-MS	CT PV-T2-1000-M	CT PV-T2-GDT-M
Article-No.	96 02 46	96 02 50	96 02 47	96 02 48

Replacement protective plug for CT PV SPD.







## Surge arresters for Photovoltaic Installations

### EnerPro 803/1003-Tr

When used in PV-installations, they are installed in the generator connection box and on the DC side of the AC converter.

Surge arrester for PV installations, with looped-in wiring.



image example

- Function control indication via LED
- Mounting on 35 mm DIN rail (EN 60715)
- Degree of protection according to IEC EN 60529: IP 20
- EAC certification
- Inflammability class according to UL 94 V0

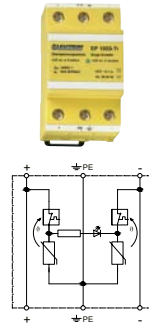
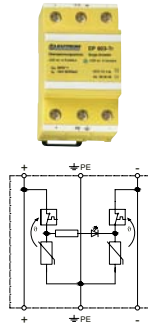
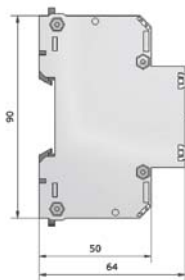

#### Technical Data

Product name	EP 803Tr	EP 1003Tr
Article-No.	39 50 26	39 50 03
IEC category	Type 2 / class II	Type 2 / class II
PV voltage	UocSTC 800 V=	1000 V=
Max. continuous operating voltage DC	Uc 895 V=	1000 V=
Protection level at In	Up ≤ 2,5 kV	≤ 3,5 kV
Protection level at 5 kA	Up ≤ 1,8 kV	≤ 3,5 kV
Response time	tA ≤ 25 ns	≤ 25 ns
Nominal discharge current (8/20 μs)	In 10 kA	5 kA
Max. impulse discharge current (8/20 μs) line-earth	Imax 20 kA	10 kA
Max. allowed fuse or back-up fuse	125 A gG	125 A gG
Operating temperature range	TU -40 - +80 °C	-40 - +80 °C
Min. conductor cross section at terminals	2,5 mm² flexible	2,5 mm² flexible
Max. conductor cross section	50mm² stranded/35mm² flexible	50mm² stranded/35mm² flexible
Max. Locking torque terminals	4,0 Nm	4,0 Nm
Enclosure material / colour	Polycarbonate UL 94-V0 / yellow	Polycarbonate UL 94-V0 / yellow
Casting compound	Polyurethan soft	Polyurethan soft



### Surge arresters for Photovoltaic Installations

#### EnerPro 802Tr /1002Tr

These devices (class II) provide overvoltage protection for the dc part in PV installations.

When used in PV-installations, they are installed in the generator connection box and on the DC side of the AC converter.



image example

- Remote signalling contact: break contact
- Function control indication via LED
- Mounting on 35 mm DIN rail (EN 60715)
- Degree of protection according to IEC EN 60529: IP 20
- Inflammability class according to UL 94 V0
- EAC certification

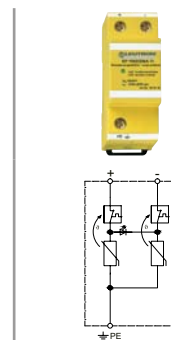
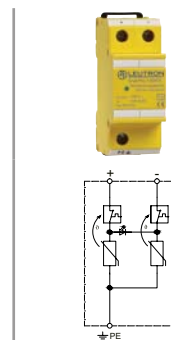
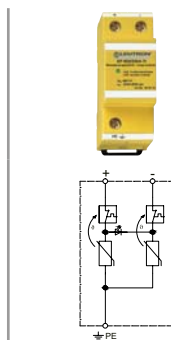
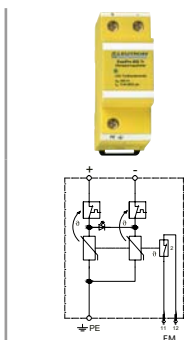
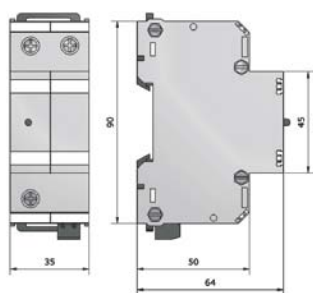

#### Technical Data

Product name	EnerPro 802Tr/Pk	EP 802/20kA-Tr	EnerPro 1002Tr	EP 1002/20kA-Tr
Article-No.	39 50 05	39 50 14	39 50 02	39 50 16
IEC category	Type 2 / class II	Type 2 / class II	Type 2 / class II	Type 2 / class II
PV voltage	UocSTC 800 V=	800 V=	1000 V=	1000 V=
Max. continuous operating voltage DC	Uc 880 V=	1000 V=	1000 V=	1000 V=
Protection level at In (8/20 μs)	Up ≤ 2,5 kV	≤ 2,5 kV	≤ 3,5 kV	≤ 4,2 kV
Protection level at 5 kA	Up ≤ 2,0 kV	≤ 2,0 kV	≤ 3,5 kV	≤ 3,5 kV
Response time	tA < 25 ns	< 25 ns	≤ 25 ns	< 25 ns
Nominal discharge current (8/20 μs)	In 5 kA	20 kA	5 kA	20 kA
Max. impulse discharge current (8/20 μs) line-earth	Imax 10 kA	40 kA	10 kA	40 kA
Max. allowed fuse or back-up fuse	125 A gG	125 A gG	125 A gG	125 A gG
Operating temperature range	TU -40 - +80 °C	-40 - +80 °C	-40 - +80 °C	-40 - +80 °C
Max. conductor cross section	50mm <sup>2</sup> stranded/35mm <sup>2</sup> flexible	50mm <sup>2</sup> stranded/35mm <sup>2</sup> flexible	50mm <sup>2</sup> stranded/35mm <sup>2</sup> flexible	50mm <sup>2</sup> stranded/35mm <sup>2</sup> flexible
Min. conductor cross section at terminals	10mm <sup>2</sup> solid/flexible	10mm <sup>2</sup> solid/flexible	10mm <sup>2</sup> solid/flexible	10mm <sup>2</sup> solid/flexible
Max. Locking torque terminals	4,0 Nm	4,0 Nm	4,0 Nm	4,0 Nm
Enclosure material / colour	Polycarbonate UL 94-V0 / yellow	Polycarbonate UL 94-V0 / yellow	Polycarbonate UL 94-V0 / yellow	Polycarbonate UL 94-V0 / yellow
Mounting on	35 mm DIN rail (EN 60715)	35 mm DIN rail (EN 60715)	35 mm DIN rail (EN 60715)	35 mm DIN rail (EN 60715)
Degree of protection (IEC EN 60529)	IP 20	IP 20	IP 20	IP 20
Switching capacity	250 V/2 A	-	-	-
Max. conductor cross section Pk	1,5 mm <sup>2</sup>	-	-	-



## UAS 230-Tr

All-purpose acoustic signalling device with test key for all surge protection devices with the nominal voltage of UN 230 V.

- For monitoring of remote contacts of surge protection devices
- Mounting on 35 mm DIN rail (EN 60715)

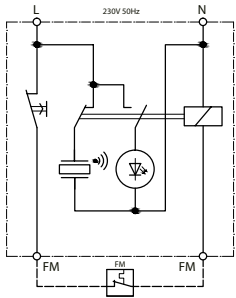





<b>Technical Data</b>		
<b>Product name</b>		<b>UAS 230-Tr</b>
Article-No.		35 10 30
Nominal voltage AC	UN	230 V~
Max. continuous operating voltage DC	Uc	240 V=
Nominal current	IL	16 A
Max. power		530 (Relais) W
Coil resistance		26,9 Ω
Max. conductor cross section		35mm <sup>2</sup> stranded/25mm <sup>2</sup> flexible
Operating temperature range	TU	-25 - +65 °C
Max. conductor cross section FM		1,5 mm <sup>2</sup>
Degree of protection (IEC EN 60529)		IP 20
Enclosure material / colour		Polycarbonate UL 94-V0 / yellow

## All-purpose busbars

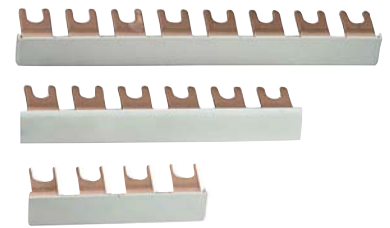
The all-purpose busbar is designed to connect the earthing of arrester class II and III lightning and surge voltage components.

- All-purpose busbar for multi-function terminals
- For an optimal bridging of the grounding terminals
- Available in different lengths



		without figure		without figure	without figure		without figure
<b>Product name</b>	<b>KA 1TE-1/2</b>	<b>KA 1TE-1/3</b>	<b>KA 1TE-1/4</b>	<b>KA 1TE-1/6</b>	<b>KA 1TE-1/8</b>	<b>KA 2TE-1/3</b>	<b>KA 2TE-1/4</b>
Article-No.	17 00 15	17 00 13	17 00 25	17 00 31	17 00 42	17 00 35	17 00 41
Dimension (DIN 43880)	2x 1TE	3x 1TE	4x 1TE	6x 1TE	8x 1TE	2x 1TE	2x 1TE

## DAK 2x16

Pin-shaped terminal to enable feed-through wiring (V-wiring) for all surge protection modules with only one clamp per phase, such as PP PV 800 and 1000 and other SPDs for power supply systems.

- Looped-in wiring for SPD with only one terminal.
- Connection of max. 2x 16 mm<sup>2</sup> fine-stranded
- Conformed by standard looped-in wiring (V connected)

<b>Technical Data</b>		
<b>Product name</b>		<b>DAK 2x 16</b>
Article-No.		17 01 10
Type of connection		vorne Doppelklemme, hinten Stiftanschluss
Conductor cross section		2x 16 mm <sup>2</sup>
Dimensions (L x B x H)		17 x 38,5 x 21 mm



## AK35 GDT230

The solution allows for a subsequent high-resistance and leakage current-free earthing with a gas-filled surge arrester (GDT) against earth at the EP protective devices.

- Equipped with two-pole gas-filled surge arrester 2EL 230Q
- Screw-type terminal
- Mounting by soldering
- Terminals are internally bridged

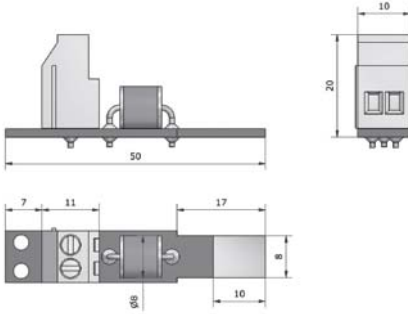

<b>Technical Data</b>	
<b>Product name</b>	<b>AK35 GDT230</b>
<b>Article-No.</b>	<b>17 01 00</b>
Nominal discharge current (8/20 μs)	20 kA
net weight/pc	10 g

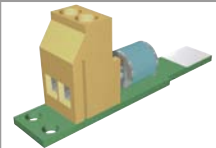

## Pulse counter

For the potential-free measurement of discharge currents of surge protective devices. Easy snap-on installation on the earth conductor with the help of an two-piece ring core.

- Pulse counting assembly in 1.5 TE DIN rail-mounted device
- including twisted sensor cable (length 1 m)
- Batteries are included in the delivery scope
- Push button to adjust the meter reading (e. g. after battery change)

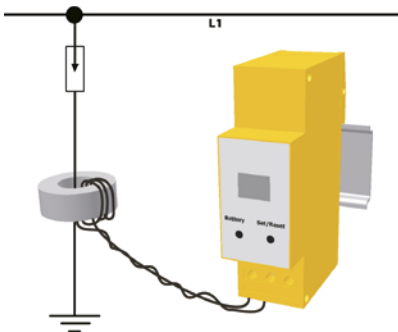

<b>Technical Data</b>	
<b>Article No.</b>	<b>LC 1</b>
<b>Article No.</b>	<b>87 00 05</b>
Impulse spark-over wave (rise time >8μs)	> 1 kA
Pulse frequency	< 1 s
LCD display	0 - 99
Power Supply	9 V battery
Operating temperature range	TU -10 - +50 C°
Mounting on	35 mm DIN rail
Enclosure material / colour	Thermoplastic, yellow
Degree of protection (IEC EN 60529)	IP 20
Length of connection cable (sensor)	max. 1 m
Dimension (L x B x H)	63 x 27 x 90 mm
Sensor max. cross section	25 mm <sup>2</sup>





## THE NEW ARRESTERS – INTERRUPTION-FREE AND IMPEDANCE-NEUTRAL PLUGGING AND UNPLUGGING WITHOUT INTERRUPTING THE SIGNAL

The two-part protection devices with a construction width of 17.5 mm cover up to seven voltage types. Devices with a one-piece terminal block design and a construction width of only 6.2 mm allow for a high packing density in control cabinets.

**Convincing application advantages thanks to a symbiosis of design and optimized packing density – Leutron's arresters for measuring systems and automatic control devices**



### MORE VERSATILE IN USE:

- Optimized basic modules for direct or indirect shield grounding via gas discharge tubes
- On pluggable surge protective devices the protection module can be detached and replaced without interrupting the signal
- Versions for one pair of wires (1 DA) with two signal lines and for two pairs of wires (2 DA) with four signal lines available



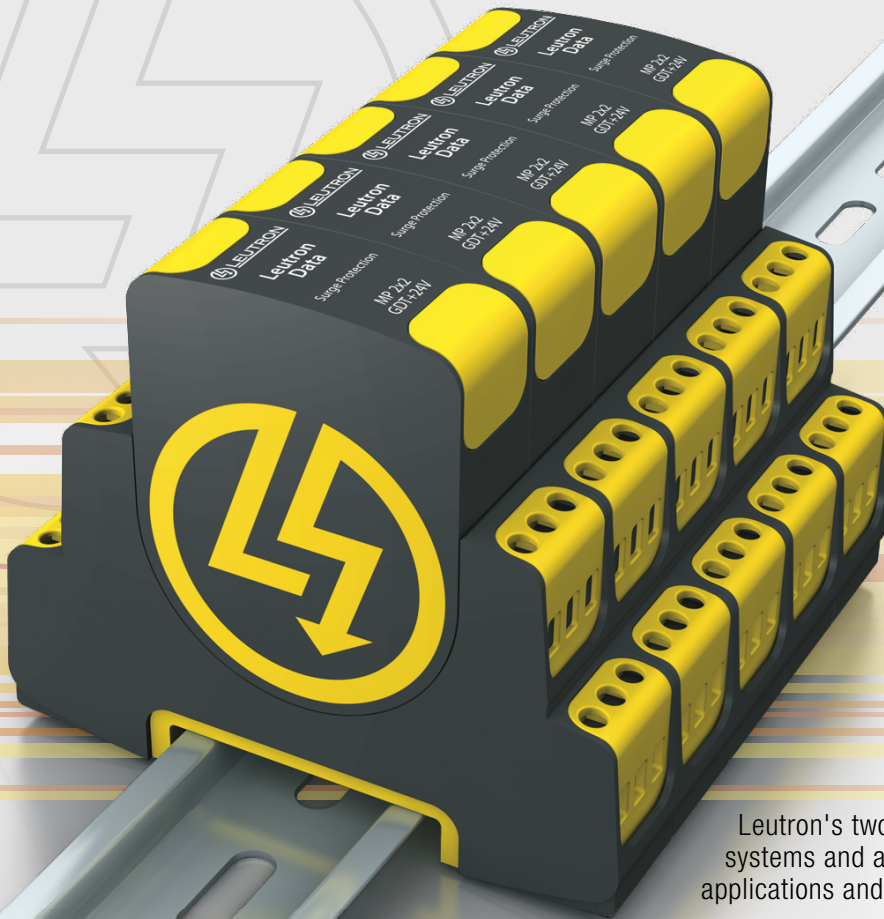

Leutron's two-piece arresters for measuring systems and automatic control devices – for all applications and voltage levels.

## **SURGE PROTECTION FOR MEASURING SYSTEMS AND AUTOMATIC CONTROL DEVICES**

## TWO-PIECE, PLUGGABLE SURGE ARRESTERS

Product line »Leutron Data«:

- Voltage levels from 5 Volt to 180 Volt DC available
- Frequency range: Dependent on the voltage level up to 170 Megahertz

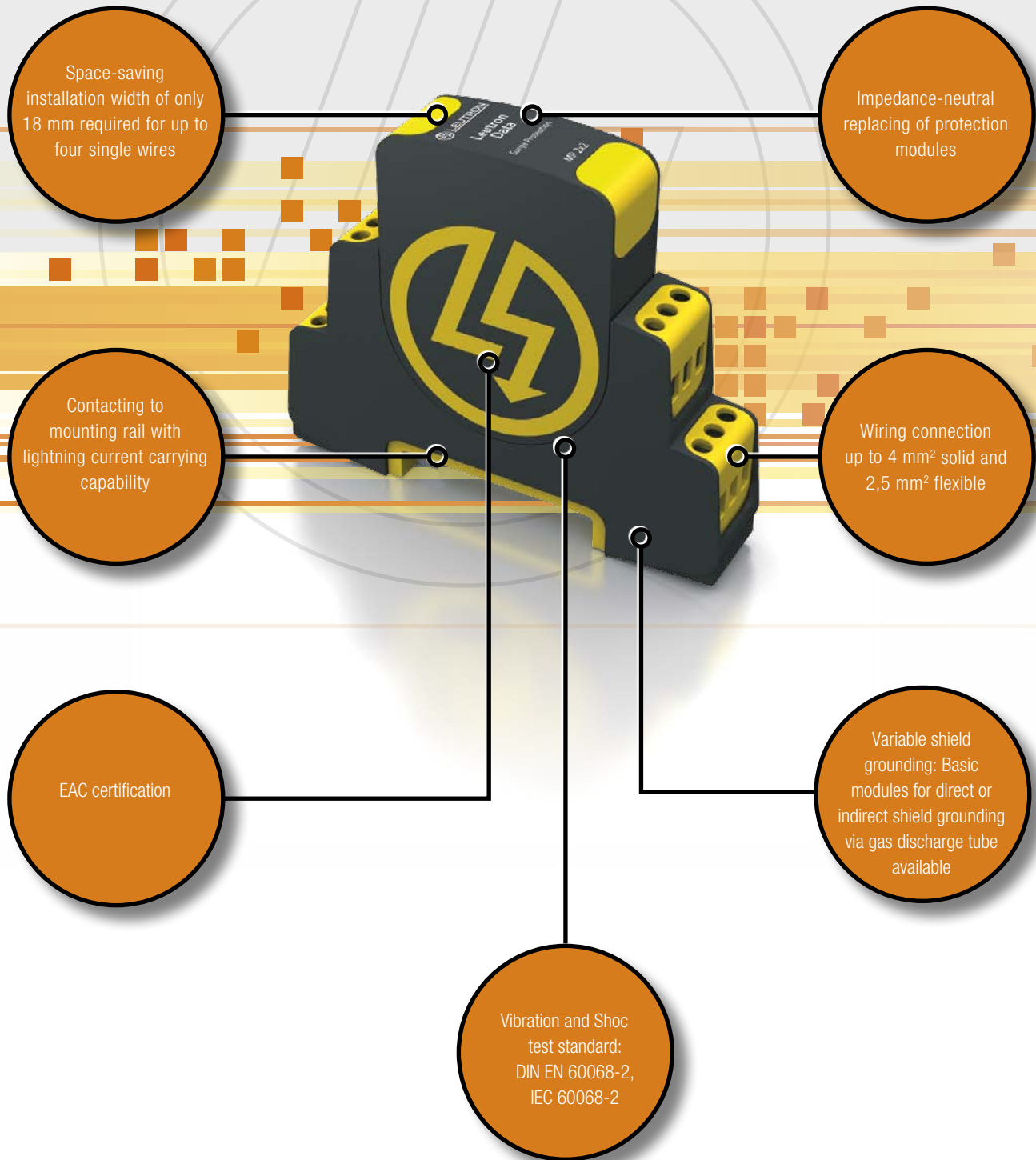





## ONE-PIECE SURGE ARRESTERS

- Voltage levels from 5 Volt to 180 Volt DC available
- Frequency range: Dependent on the voltage level up to 25 Megahertz

Space-saving installation  
width of only 6.2 mm

Contacting to  
mounting rail with  
lightning current carrying  
capability

EAC certification

Wiring connection up  
to 4 mm<sup>2</sup> solid and  
2,5 mm<sup>2</sup> flexible



# SURGE PROTECTION FOR MEASURING SYSTEMS AND AUTOMATIC CONTROL DEVICES

## SELECTION GUIDE

Interface / Signal	Connection	Protected lines	Protection device	Article-No.	Page
0-20 mA, 4-20 mA	Screw terminals	4	MP 2x2 GDT+24V-Ad-Pg ST	97 00 27	116
(auch mit HART)	Screw terminals	2	MP 1x2 GDT+24V-Ad-Ad ST	97 00 20	113
	Screw terminals	2	MP RK GDT+24V-Ad-Pg	97 10 13	131
	Screw terminals	2	MP RK 24V-Ad-Pg	97 10 34	134
4-20 mA	Screw terminals	4	MP 2x2 GDT+24V-Ad-Ad ST	97 00 13	112
(also with HART) acc. to NAMUR recom-	Screw terminals	2	MP 1x2 GDT+24V-Ad-Ad ST	97 00 20	113
mendation NE 21 or acc. to EN 61000-4-5,	Screw terminals	2	MP RK GDT+24V-Ad-Ad	97 10 06	130
Open-circuit voltage 1 kV Ad-Pg	LSA	2	DP 1LSA-24	24 00 34	154
	LSA	20	DP 10LSA-PTC-24V	24 00 28	160
3/4-Signal Measurement	Screw terminals	4	MP 2x2 GDT+24V-Ad-Pg ST	97 00 27	116
ADVANT	Screw terminals	4	MP 2x2 GDT+5V-Ad-Ad-Pg ST	97 00 39	119
	Screw terminals	2	MP 1x2 GDT+5V-Ad-Ad-Pg ST	97 00 46	121
	Screw terminals	2	MP RK GDT+5V-Ad-Ad-Pg	97 10 18	129
Binary signals	Screw terminals	4	MP 2x2 GDT+XXV-Ad-Pg ST	97 00 25 - 97 00 31	116 f.
	Screw terminals	2	MP 1x2 GDT+XXV-Ad-Pg ST	97 00 32 - 97 00 38	117 f.
	Screw terminals	2	MP RK GDT+XXV-Ad-Pg	97 10 11 - 97 10 17	131 f.
	Screw terminals	2	MP RK XXV-Ad-Pg	97 10 32 - 97 10 38	134 f.
	LSA	2	DP 1LSA-XX	24 00 31 - 24 00 39	154 f.
	LSA	20	DP 10LSA-PTC-24V	24 00 28	160
Bitbus	Screw terminals	4	MP 2x2 5V-HF ST	97 10 50	123
	Screw terminals	2	MP 1x2 5V-HF ST	97 10 52	123
BLN	Screw terminals	4	MP 2x2 GDT+12V-Ad-Ad ST	97 00 12	112
(Building Level Netzwerk)	Screw terminals	4	MP 2x2 GDT+48V-Ad-Ad ST	97 00 15	113
	Screw terminals	2	MP 1x2 GDT+12V-Ad-Ad ST	97 00 19	113
	Screw terminals	2	MP 1x2 GDT+48V-Ad-Ad ST	97 00 22	114
	Screw terminals	2	MP RK GDT+12V-Ad-Ad	97 10 05	130
	Screw terminals	2	MP RK GDT+48V-Ad-Ad	97 10 08	131
CAN-Bus	Screw terminals	4	MP 2x2 5V-HF ST	97 10 50	123
(nur Datenleitung)	Screw terminals	2	MP 1x2 5V-HF ST	97 10 52	123
C-Bus	Screw terminals	4	MP 2x2 5V-HF ST	97 10 50	123
(Honeywell)	Screw terminals	2	MP 1x2 5V-HF ST	97 10 52	123
Data Highway Plus	Screw terminals	4	MP 2x2 GDT+12V-Ad-Ad ST	97 00 12	112
	Screw terminals	2	MP 1x2 GDT+12V-Ad-Ad ST	97 00 19	113
Delta Net Peer Bus	Screw terminals	4	MP 2x2 5V-HF ST	97 10 50	123
	Screw terminals	2	MP 1x2 5V-HF ST	97 10 52	123
Device Net	Screw terminals	4	MP 2x2 5V-HF ST	97 10 50	123
(data line only)	Screw terminals	2	MP 1x2 5V-HF ST	97 10 52	123
Dupline	Screw terminals	2	MP 1x2 GDT+24V-Ad-Ad ST	97 00 20	113
E-Bus	Screw terminals	4	MP 2x2 GDT+48V-Ad-Ad ST	97 00 15	113
(Honeywell)	Screw terminals	2	MP 1x2 GDT+48V-Ad-Ad ST	97 00 22	114
EIB	Screw terminals	4	MP 2x2 GDT ST	97 00 07	111
	Screw terminals	2	MP 1x2 GDT ST	97 00 10	111
	Screw terminals	2	MP RK GDT	97 10 03	128
	LSA	20	TelPro LSA-3EH230F1E-10kA	24 01 23	152
Electro acoustic system (ELA)	Screw terminals	4	MP 2x2 GDT ST	97 00 07	111
	Screw terminals	2	MP 1x2 GDT ST	97 00 10	111
	Screw terminals	2	MP RK GDT	97 10 03	128
	Screw terminals	4	MP 2x2 GDT+170V-Ad-Pg ST	97 00 31	117
	Screw terminals	2	MP 1x2 GDT+170V-Ad-Pg ST	97 00 38	118
	Screw terminals	2	MP RK GDT+170V-Ad-Pg	97 10 17	132
	LSA	2	DP 1LSA-110	24 00 39	155



Interface / Signal	Connection	Protected lines	Protection device	Article-No.	Page
	LSA	20	DP 10LSA-110	24 01 40	160
ET 200	Screw terminals	4	MP 2x2 5V-HF ST	97 10 50	123
	Screw terminals	2	MP 1x2 5V-HF ST	97 10 52	123
Fieldbus Foundation	Screw terminals	4	MP 2x2 GDT+24V-Ad-Ad ST	97 00 13	112
	Screw terminals	2	MP 1x2 GDT+24V-Ad-Ad ST	97 00 20	113
	Screw terminals	2	MP RK GDT+24V-Ad-Ad	97 10 06	130
	LSA	20	DP 10LSA-PTC-24V	24 00 28	160
FIPIO / FIPWAY	Screw terminals	4	MP 2x2 GDT+24V-Ad-Ad ST	97 00 13	112
	Screw terminals	2	MP 1x2 GDT+24V-Ad-Ad ST	97 00 20	113
	Screw terminals	2	MP RK GDT+24V-Ad-Ad	97 10 06	130
FIP I/O	Screw terminals	4	MP 2x2 5V-HF ST	97 10 50	123
	Screw terminals	2	MP 1x2 5V-HF ST	97 10 52	123
FSK	Screw terminals	4	MP 2x2 5V-HF ST	97 10 50	123
	Screw terminals	2	MP 1x2 5V-HF ST	97 10 52	123
Genius I/O Bus	Screw terminals	4	MP 2x2 GDT+12V-Ad-Ad ST	97 00 12	112
	Screw terminals	2	MP 1x2 GDT+12V-Ad-Ad ST	97 00 19	113
	Screw terminals	2	MP RK GDT+12V-Ad-Ad	97 10 05	130
DC power supply +24/30 V	Screw terminals	2	DP2x1-RLC/50V-Tr	28 70 50	189
IEC-Bus (RS 486)	Screw terminals	4	MP 2x2 5V-HF ST	97 10 50	123
	Screw terminals	2	MP 1x2 5V-HF ST	97 10 52	123
Industrial Ethernet	RJ45	8	DP RJ45-CAT6-48V-Tr	24 00 05	143
	RJ45	8	DP RJ45 f/f	24 00 11	144
	RJ45	8	DP 1xRJ45-PoE-Alu	24 00 21	145
	RJ45	8 x 8	DP 8xRJ45-6V-WG	19 40 50	146
	RJ45	8 x 8	DP 1x8RJ45-19"	19 40 13	147
	RJ45	16 x 8	DP 2x8RJ45-19"	19 40 23	147
	RJ45	24 x 8	DP 3x8RJ45-19"	19 40 33	147
	RJ45	32 x 8	DP 4x8RJ45-19"	19 40 43	147
	RJ45	40 x 8	DP 5x8RJ45-19"	19 40 53	148
	RJ45	48 x 8	DP 6x8RJ45-19"	19 40 63	148
	RJ45	8	CPS-F 230/RJ45/RJ11	32 50 45	77
INTERBUS-INLINE (I/O)	Screw terminals	4	MP 2x2 GDT+48V-Ad-Ad ST	97 00 15	113
	Screw terminals	2	MP 1x2 GDT+48V-Ad-Ad ST	97 00 22	114
	Screw terminals	2	MP RK GDT+48V-Ad-Ad	97 10 08	131
INTERBUS-Loop	Screw terminals	2	MP RK 24V-Ad-Pg	97 10 34	134
Interbus INLINE Fernbus	Screw terminals	4	MP 2x2 5V-HF ST	97 10 50	123
	Screw terminals	2	MP 1x2 5V-HF ST	97 10 52	123
K-Bus	Screw terminals	4	MP 2x2 GDT+24V-Ad-Ad ST	97 00 13	112
	Screw terminals	2	MP 1x2 GDT+24V-Ad-Ad ST	97 00 20	113
	Screw terminals	2	MP RK GDT+24V-Ad-Ad	97 10 06	130
KBR-Energy bus	Screw terminals	4	MP 2x2 5V-HF ST	97 10 50	123
	Screw terminals	2	MP 1x2 5V-HF ST	97 10 52	123
KNX-Bus	Screw terminals	4	MP 2x2 GDT ST	97 00 07	111
	Screw terminals	2	MP 1x2 GDT ST	97 00 10	111
	Screw terminals	2	MP RK GDT	97 10 03	128
	LSA	20	TelPro LSA-3EH230F1E-10kA	24 01 23	152
LON					
- TP/XF 78	Screw terminals	4	MP 2x2 GDT+5V-Ad-Ad ST	97 00 11	112
	Screw terminals	2	MP 1x2 GDT+5V-Ad-Ad ST	97 00 18	113
	Screw terminals	2	MP RK GDT+5V-Ad-Ad	97 10 04	130



# SURGE PROTECTION FOR MEASURING SYSTEMS AND AUTOMATIC CONTROL DEVICES

## SELECTION GUIDE

Interface / Signal	Connection	Protected lines	Protection device	Article-No.	Page
- TP/FTT10 und TP/LPT10	Screw terminals	4	MP 2x2 GDT+48V-Ad-Ad ST	97 00 15	113
	Screw terminals	2	MP 1x2 GDT+48V-Ad-Ad ST	97 00 22	114
	Screw terminals	2	MP RK GDT+48V-Ad-Ad	97 10 08	131
- TP/FTT 10	Screw terminals	4	MP 2x2 5V-HF ST	97 10 50	123
	Screw terminals	2	MP 1x2 5V-HF ST	97 10 52	123
LUXMATE-Bus	Screw terminals	4	MP 2x2 GDT+24V-Ad-Ad ST	97 00 13	112
	Screw terminals	2	MP 1x2 GDT+24V-Ad-Ad ST	97 00 20	113
	Screw terminals	2	MP RK GDT+24V-Ad-Ad	97 10 06	130
M-Bus	Screw terminals	4	MP 2x2 GDT+48V-Ad-Ad ST	97 00 15	113
	Screw terminals	2	MP 1x2 GDT+48V-Ad-Ad ST	97 00 22	114
	Screw terminals	2	MP RK GDT+48V-Ad-Ad	97 10 08	131
MODBUS	Screw terminals	4	MP 2x2 5V-HF ST	97 10 50	123
	Screw terminals	2	MP 1x2 5V-HF ST	97 10 52	123
MPI Bus	Screw terminals	4	MP 2x2 5V-HF ST	97 10 50	123
	Screw terminals	2	MP 1x2 5V-HF ST	97 10 52	123
N1 LAN	Screw terminals	4	MP 2x2 5V-HF ST	97 10 50	123
	Screw terminals	2	MP 1x2 5V-HF ST	97 10 52	123
N2 Bus	Screw terminals	4	MP 2x2 5V-HF ST	97 10 50	123
(Johnson Controls, LON, FTT 10)	Screw terminals	2	MP 1x2 5V-HF ST	97 10 52	123
Optocoupler Interface	Screw terminals	4	MP 2x2 GDT+24V-Ad-Ad-Pg ST	97 00 41	119
	Screw terminals	2	MP 1x2 GDT+24V-Ad-Ad-Pg ST	97 00 48	121
	Screw terminals	2	MP RK GDT+24V-Ad-Ad-Pg	97 10 20	129
Procontic SC31	Screw terminals	2	MP 2x2 GDT+12V-Ad-Pg ST	97 00 26	116
(RS 232)					
Procontic T200	Screw terminals	4	MP 2x2 5V-HF ST	97 10 50	123
(RS 422)					
PROFIBUS-DP/FMS	Screw terminals	4	MP 2x2 5V-HF ST	97 10 50	123
	Screw terminals	2	MP 1x2 5V-HF ST	97 10 52	123
PROFIBUS-PA	Screw terminals	4	MP 2x2 GDT+24V-Ad-Ad ST	97 00 13	112
	Screw terminals	2	MP 1x2 GDT+24V-Ad-Ad ST	97 00 20	113
	Screw terminals	2	MP RK GDT+24V-Ad-Ad	97 10 06	130
	LSA	2	DP 1LSA-C24FS-PTC	24 00 66	158
PROFIBUS SIMATIC NET	Screw terminals	4	MP 2x2 5V-HF ST	97 10 50	123
	Screw terminals	2	MP 1x2 5V-HF ST	97 10 52	123
PSM-EG-RS 422	Screw terminals	4	MP 2x2 5V-HF ST	97 10 50	123
PSM-EG-RS 485	Screw terminals	4	MP 2x2 5V-HF ST	97 10 50	123
	Screw terminals	2	MP 1x2 5V-HF ST	97 10 52	123
Rackbus (RS 485)	Screw terminals	4	MP 2x2 5V-HF ST	97 10 50	123
	Screw terminals	2	MP 1x2 5V-HF ST	97 10 52	123
R-Bus	Screw terminals	4	MP 2x2 GDT+5V-Ad-Ad ST	97 00 11	112
	Screw terminals	2	MP 1x2 GDT+5V-Ad-Ad ST	97 00 18	113
	Screw terminals	2	MP RK GDT+5V-Ad-Ad	97 10 04	130
RS 485	Screw terminals	4	MP 2x2 5V-HF ST	97 10 50	123
	Screw terminals	2	MP 1x2 5V-HF ST	97 10 52	123
	LSA	2	DP 1LSA-C24FS-PTC	24 00 66	158
RS 422, V11	Screw terminals	4	MP 2x2 5V-HF ST	97 10 50	123
	Screw terminals	2	MP 1x2 5V-HF ST	97 10 52	123
S-Bus	Screw terminals	4	MP 2x2 5V-HF ST	97 10 50	123
	Screw terminals	2	MP 1x2 5V-HF ST	97 10 52	123
SafetyBUS p	Screw terminals	4	MP 2x2 5V-HF ST	97 10 50	123
	Screw terminals	2	MP 1x2 5V-HF ST	97 10 52	123



Interface / Signal	Connection	Protected lines	Protection device	Article-No.	Page
SDLC	Screw terminals	4	MP 2x2 5V-HF ST	97 10 50	123
	Screw terminals	2	MP 1x2 5V-HF ST	97 10 52	123
Securilan-LON-Bus (LONWORKS Technology)	Screw terminals	4	MP 2x2 GDT+5V-Ad-Ad ST	97 00 11	112
	Screw terminals	2	MP 1x2 GDT+5V-Ad-Ad ST	97 00 18	113
standard bus based on Echelon)	Screw terminals	2	MP RK GDT+5V-Ad-Ad	97 10 04	130
SIGMASYS (Siemens Fire alarm systems)	Screw terminals	4	MP 2x2 GDT+48V-Ad-Ad ST	97 00 15	113
	Screw terminals	2	MP 1x2 GDT+48V-Ad-Ad ST	97 00 22	114
	Screw terminals	2	MP RK GDT+48V-Ad-Ad	97 10 08	131
	Screw terminals	4	MP 2x2 GDT+48V-Ad-Pg ST	97 00 29	117
	Screw terminals	2	MP 1x2 GDT+48V-Ad-Pg ST	97 00 36	118
	Screw terminals	2	MP RK GDT+48V-Ad-Pg	97 10 15	132
SINEC L1	Screw terminals	4	MP 2x2 5V-HF ST	97 10 50	123
	Screw terminals	2	MP 1x2 5V-HF ST	97 10 52	123
SINEC L2	Screw terminals	4	MP 2x2 5V-HF ST	97 10 50	123
	Screw terminals	2	MP 1x2 5V-HF ST	97 10 52	123
SS97 SIN/X (RS 232)	Screw terminals	4	MP 2x2 GDT+12V-Ad-Pg ST	97 00 26	116
	Screw terminals	2	MP 1x2 GDT+12V-Ad-Pg ST	97 00 33	117
	Screw terminals	2	MP RK GDT+12V-Ad-Pg	97 10 12	131
SUCONET	Screw terminals	4	MP 2x2 GDT+5V-Ad-Ad ST	97 00 11	112
	Screw terminals	2	MP 1x2 GDT+5V-Ad-Ad ST	97 00 18	113
	Screw terminals	2	MP RK GDT+5V-Ad-Ad	97 10 04	130
Temperature measuring	Screw terminals	4	MP 2x2 GDT+5V-Ad-Pg ST	97 00 25	116
PT 100, PT 1000, Ni 1000, NTC, PTC	Screw terminals	2	MP 1x2 GDT+5V-Ad-Pg ST	97 00 32	117
	Screw terminals	2	MP RK GDT+5V-Ad-Pg	97 10 11	131
TTL	Screw terminals	4	MP 2x2 GDT+12V-Ad-Pg ST	97 00 26	116
	Screw terminals	2	MP 1x2 GDT+12V-Ad-Pg ST	97 00 33	117
	Screw terminals	2	MP RK GDT+12V-Ad-Pg	97 10 12	131
TTY 4 - 20 mA	Screw terminals	4	MP 2x2 GDT+24V-Ad-Pg ST	97 00 27	116
	Screw terminals	2	MP 1x2 GDT+24V-Ad-Pg ST	97 00 34	117
	Screw terminals	2	MP RK GDT+24V-Ad-Pg	97 10 13	131
	Screw terminals	2	MP RK 24V-Ad-Pg	97 10 34	134

### Test Categories for SPDs in Information Technology acc. to table 3 of DIN EN 61643-21/VDE 0845-3-1: 2013-07

Category	Test type	Impulse voltage	Impuls current	Minimum number of impulses	Test for
C1	fast rising edge	0,5 kV or 1 kV (1,2/50 µs)	0,25 kA or 0,5 kA (8/20 µs)	300	Surge arrester
C2		2 kV, 4 kV or 10 kV (1,2/50 µs)	1 kA, 2 kA or 5 kA (8/20 µs)	10	
C3		≥ 1 kV, 1 kV/µs	10 A, 25 A or 100 A (10/1000 µs)	300	
D1	high energy	≥ 1 kV	0,5 kA, 1 kA or 2,5 kA (10/350 µs)	2	Lightning current combined arrester

Product standard for surge protection devices for application in telecommunication and signal processing net works - performance requirements and test procedures.

According to the product standard DIN EN 61643-21 (VDE 0845 part 3 all surge protection devices have to be tested during type tests with predefined minimum pulses according to the voltage and current pulses defined in table below.

In doing so, the SPDs are classified into test categories with respect to their specification.

The category C represents disturbance pulses with steep rising edge and low energy level. The category D represents exposures to high energy levels, e.g. partial lightning currents.



# SURGE PROTECTION FOR MEASURING SYSTEMS AND AUTOMATIC CONTROL DEVICES

## SURGE PROTECTION FOR DANGER DETECTION SYSTEM

### Highest level of availability in security systems

Today, complex security systems consist more and more of sensitive electronics. Therefore, it is necessary to include these security systems when considering a lightning and surge protection concept.

Especially, an outage of security installations which are installed at sensitive locations in commerce, industry and private sectors may cause high costs and subsequent damage.

According to insurance associations, lightning strikes and surges are one of the most frequent causes for the breakdown of high quality electrotechnical equipment and, thus, resulting in subsequent damage.

As a specialist for fire alarm systems, burglar alarm systems, video surveillance systems or danger detection systems you are the direct contact person for the operator and can assess the weak spots on-site.

Benefit from Leutron's years of experience in the area of internal lightning and surge protection. Our products which are manufactured in Germany constantly prove their reliability through sophisticated technology.

Figure 1 depicts the interfaces of security installations which should be integrated into the security concept according to VDE 0185305 and VdS guidelines.

### Advantages of Leutron's lightning and surge protection components in building technology

- Consistent overall concept
- Increased reliability
- Undisturbed operation of IT systems and safety equipment
- Fewer false alarms
- Protection modules of the MP series can be removed and changed without interfering with other signals
- Versions for two pair of wires (2 DA) with four signal lines available
- Space-saving installation of the MP series
- Surges and overvoltages are limited to non-hazardous values (low protection level)

### PRODUCT SELECTION

Products on power side (230 V)	Item No.	IEC test class/ EN Type	
CT-T1+2/3+1-350-FM	96 00 01	Type 1 + 2 / class I+II	4-pole, with signal remote contact
EL-T2/4+0-275-FM	38 81 02	Type 2 / class II	4-pole, with signal remote contact
EL-T2/2+0-275-FM	38 81 58	Type 2 / class II	2-pole, with signal remote contact
Products on signal side	Item No.	IEC test class/ EN Type	Protected wires
MP 2x2 GDT+12V-Ad-Pg ST *1 *2	97 00 26	D1/C2/C1/C3	2 DA
MP 2x2 GDT+24V-Ad-Pg ST *1 *2	97 00 27	D1/C2/C1/C3	2 DA
MP 2x2 GDT+5V-Ad-Ad-Pg ST *1 *2	97 00 39	D1/C2/C1/C3	2 DA
MP 2x2 GDT+12V-Ad-Ad-Pg ST *1 *2	97 00 40	D1/C2/C1/C3	2 DA
MP 2x2 GDT+24V-Ad-Ad-Pg ST *1 *2	97 00 41	D1/C2/C1/C3	2 DA
MP 2x2 GDT+36V-Ad-Ad-Pg ST *1 *2	97 00 42	D1/C2/C1/C3	2 DA
MP 2x2 GDT+48V-Ad-Ad-Pg ST *1 *2	97 00 43	D1/C2/C1/C3	2 DA
MP 2x2 GDT+60V-Ad-Ad-Pg ST *1 *2	97 00 44	D1/C2/C1/C3	2 DA
MP 2x2 GDT+170V-Ad-Ad-Pg ST *1 *2	97 00 45	D1/C2/C1/C3	2 DA
MP 2x2 24V-HF ST *3 *4	97 10 51	D1/C2/C1/C3	2 DA
MP 2x2 GDT+60V-Ad-Ad ST *1 *2	97 00 16	D1/C2/C1/C3	2 DA
DataPro Koax-8V-BNC-75 Ohm	54 43 40	D1/C2/C1/C3	
DP RJ45-CAT6-48V-Tr	24 00 05	D1/C2/C1/C3	8 signal wires
DP 8xRJ45-6V-WG	19 40 50	C2/C1/C3	8 signal wires
DP 1xRJ45-PoE-Alu	24 00 21	C2/C1/C3	8 signal wires
DP 3x8RJ45-19"	19 40 33	C2/C1/C3	24 x 8 wires
*1 MP Base 2x2 Base-R (Accessories)	97 00 00	-	Plug base with direct grounding
*2 MP Base 2x2 Base-R GDT (Accessories)	97 00 01	-	Plug base with indirect grounding
*3 MP Base 2x2 (Accessories)	97 00 03	-	Plug base with direct grounding
*4 MP Base 2x2 GDT (Accessories)	97 00 04	-	Plug base with indirect grounding

# SURGE PROTECTION FOR MEASURING SYSTEMS AND AUTOMATIC CONTROL DEVICES

## SURGE PROTECTION FOR DANGER DETECTION SYSTEM

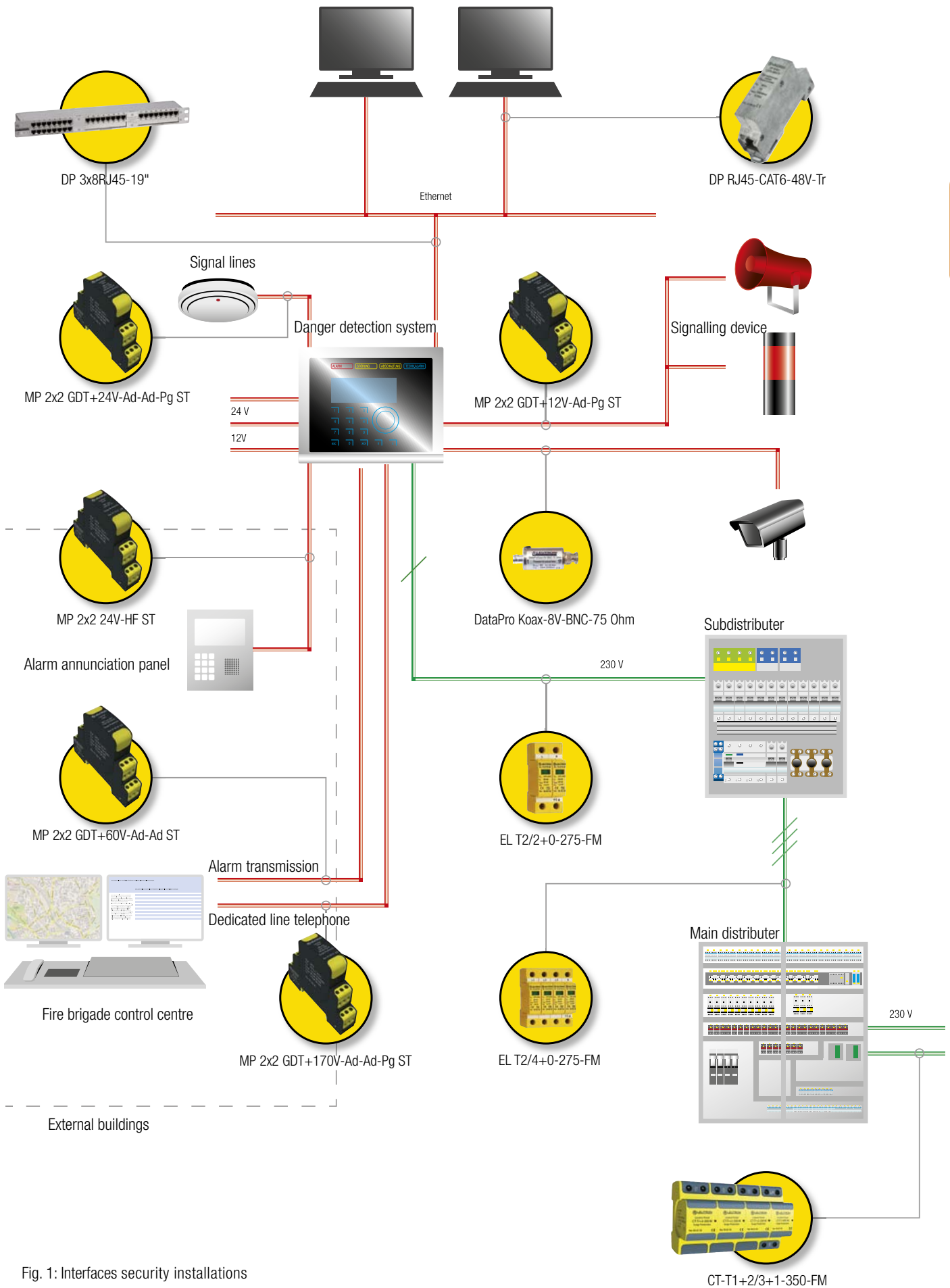

Fig. 1: Interfaces security installations



# SURGE PROTECTION FOR MEASURING SYSTEMS AND AUTOMATIC CONTROL DEVICES

## TABLE OF CONTENTS

Pluggable SPD for MCR applications		Page	
<b>Pluggable SPD with high discharge capability for MCR applications</b>		<b>111</b>	
MP 2x2 GDT ST	Protective for 2 double or 4 single wires	111	
MP 1x2 GDT ST	Protective for 1 double or 2 single wires	111	
<b>Pluggable SPD with high discharge capability and low protection level for MCR applications</b>		<b>112</b>	
MP 2x2 GDT/Ad-Ad ST	Protective for 2 double or 4 single wires	112	
MP 1x2 GDT/Ad-Ad ST	Protective for 1 double or 2 single wires	113	
MP 1x2 GDT/Ad-Ad-FM	Protective for 1 double or 2 single wires	115	
MP 2x2 GDT/Ad-Pg ST	Protective for 2 double or 4 single wires	116	
MP 1x2 GDT/Ad-Pg ST	Protective for 1 double or 2 single wires	117	
MP 2x2 GDT/Ad-Ad-Pg ST	Protective for 2 double or 4 single wires	119	
MP 1x2 GDT/Ad-Ad-Pg ST	Protective for 1 double or 2 single wires	121	
<b>Pluggable SPD for high frequency MCR applications</b>		<b>123</b>	
MP 2x2 HF ST	Max. frequency 70 MHz	Protective for 2 double or 4 single wires	123
MP 1x2 HF ST	Max. frequency 70 MHz	Protective for 1 double or 2 single wires	123
MP 2x2-170-HF ST	Max. frequency 170 MHz	Protective for 2 double or 4 single wires	124
MP 1x2-170 HF ST	Max. frequency 170 MHz	Protective for 1 double or 2 single wires	124
<b>Allocation MP modules to sockets (MP Base)</b>		<b>125</b>	
<b>One-piece SPD for MCR applications</b>			
<b>RS485 product</b>		<b>126</b>	
DataPro RS485-Tr	Max. frequency 1 MHz		126
<b>One-piece SPD for MCR applications for high frequency</b>		<b>127</b>	
DataPro 2x1-SDSL-Tr	Max. frequency 300 MHz		127
DataPro 4x1-SDSL-Tr	Max. frequency 300 MHz		127
<b>One-piece SPD with high discharge capability for MCR applications</b>		<b>128</b>	
IsoProData-Tr			128
MP RK GDT (Terminal strips only with GDT)	Protective circuit for 2 signal lines without reference to ground potential		128
<b>One-piece SPD with high discharge capability and low protection level for MCR applications</b>		<b>129</b>	
MP RK GDT/Ad-Ad-Pg	Protective circuit for 2 signal lines with common ground		129
MP RK GDT/Ad-Ad	Protective circuit for 2 signal lines without reference to ground potential		130
MP RK GDT/Ad-Pg	Protective circuit for 2 signal lines with common ground		131
<b>One-piece SPD with low protection level for MCR applications</b>		<b>133</b>	
MP RK/Ad-Ad	Protective circuit for 2 signal lines without reference to ground potential		133
MP RK/Ad-Pg	Protective circuit for 2 signal lines with common ground		134
MP RK/Ad-Ad-Pg	Protective circuit for 2 signal lines with common ground		135
<b>SPD for field devices</b>		<b>137</b>	
MSR-M20			137





### Pluggable SPD with high discharge capability for MCR applications

#### MP 2x2 GDT ST/ MP 1x2 GDT ST

Plug-in module for consistently pluggable two-parts arrester for signal lines. The protective module can be removed for test or maintenance purposes without changing the line impedance and therefore influencing the signal level. The base part can remain in the installation without manipulating or removing any wire.

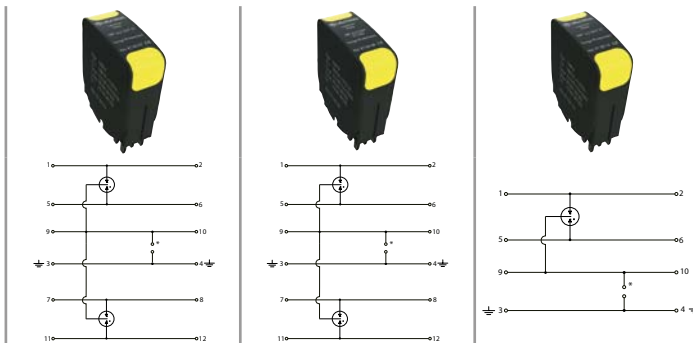

image example

- Protective for 2 double or 4 single wires at MP 2x2
- Protective for 1 double or 2 single wires at MP 1x2
- Test standard: IEC 61643-21 / EN 61643-21
- Vibration test standard: DIN EN 60068-2-6, IEC 60068-2-6
- Shock test standard: DIN EN 60068-2-27, IEC 60068-2-27
- Applicable at the boundaries LPZ 0A - 1 and higher
- Mounting on 35 mm DIN rail (EN 60715)
- Enclosure material: thermoplastic
- Space required for installation: 17.5 mm
- Degree of protection according to IEC EN 60529: IP 20
- Inflammability class according to UL 94 V0
- EAC certificated

**MP2x2** 2 Double wires  
4 Single wires

**MP1x2** 1 Double wires  
2 Single wires



**Technical Data**

Product name	MP 2x2 GDT ST	MP 2x2 GDT ST-350	MP 1x2 GDT ST
Article-No.	97 00 07	97 00 08	97 00 10
IEC category	D1 / C2 / C1 / C3	D1 / C2 / C1 / C3	D1 / C2 / C1 / C3
Nominal voltage DC	UN 180 V=	350 V=	180 V=
Max. continuous operating voltage (DC/AC)	Uc 180/120 V	350/255 V	180/120 V
Nominal current	IL 2 A	2 A	2 A
D1 lightning impulse current (10/350 μs) per line	Iimp 2,5 kA	2,5 kA	2,5 kA
C2 nominal discharge current (8/20 μs) total	I <sub>max</sub> 20 kA	20 kA	20 kA
C2 nominal discharge current (8/20 μs) per line	I <sub>n</sub> 10 kA	10 kA	10 kA
Protection level line-line at Iimp D1	Up ≤ 550 V	≤ 550 V	≤ 550 V
Protection level line-earth at Iimp D1	Up ≤ 550 V	≤ 550 V	≤ 550 V
Protection level line-line at 1 kV/μs C3	Up ≤ 500 V	≤ 500 V	≤ 500 V
Protection level line-Pg at 1 kV/μs C3	Up ≤ 500 V	≤ 500 V	≤ 500 V
Series resistance per line	Rs 0 Ω	0 Ω	0 Ω
Max. frequency (-3 dB)	fG typ. 100 MHz	typ. 100 MHz	typ. 100 MHz
Conductor cross section (solid/stranded/AWG)	0.2-4.0/0.2-2.5 mm <sup>2</sup> / 24-12	0.2-4.0/0.2-2.5 mm <sup>2</sup> / 24-12	0.2-4.0/0.2-2.5 mm <sup>2</sup> / 24-12
Operating temperature range	TU -40 - +80 °C	-40 - +80 °C	-40 - +80 °C

*Accessories: Plugsocket (Base)	for MP 2x2 GDT ST			for MP 1x2 GDT ST		
	MP Base 2x2	MP Base 2x2 GDT	MP Base 2x2 GND	MP Base 1x2	MP Base 1x2 GDT	MP Base 1x2 GND
Article-No.	97 00 03	97 00 04	97 00 92	97 00 97	97 00 98	97 00 94

Different base parts provide either direct or indirect earthing of the signal: The MP Base 2x2 (1x2) is not connected to 9/10 of DIN rail linked (galvanic insulation). The MP Base 2x2 (1x2) GDT has a gas discharge tube linked between the connectors 9/10 and the DIN rail and earth connector.

Therefore a galvanic insulation between the signal line and the earth connection (PE) can be reached. The MP Base 2x2 (1x2) GND is connected by a bridge to DIN rail (no galvanic insulation).





### Pluggable SPD with high discharge capability and low protection level for MCR applications

#### MP 2x2 GDT/Ad-Ad ST / MP 1x2 GDT/Ad-Ad ST

Fully pluggable two-parts arrester for signal lines. The protective module can be removed for test or maintenance purposes without changing the line impedance and therefore influencing the signal level. The base part can remain in the installation without manipulating or removing any wire.



image example

- Protective for 2 double or 4 single wires at MP 2x2
- Protective for 1 double or 2 single wires at MP 1x2
- Protective plug can be removed without changing the line impedance or influencing the useful signal
- Test standard: IEC 61643-21 / EN 61643-21
- Vibration test standard: DIN EN 60068-2-6, IEC 60068-2-6
- Shock test standard: DIN EN 60068-2-27, IEC 60068-2-27
- Applicable at the boundaries LPZ 0A - 1 and higher
- Mounting on 35 mm DIN rail (EN 60715)
- Enclosure material: thermoplastic
- Space required for installation: 17.5 mm
- Degree of protection according to IEC EN 60529: IP 20
- Inflammability class according to UL 94 V0
- EAC certificated

### MP2x2 2 Double wires 4 Single wires

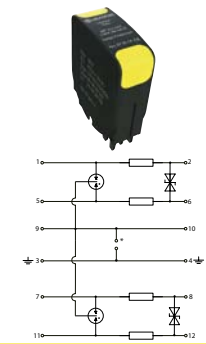
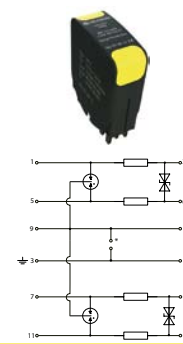
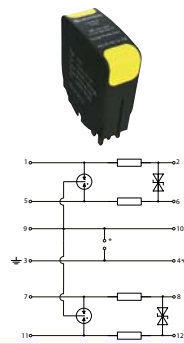
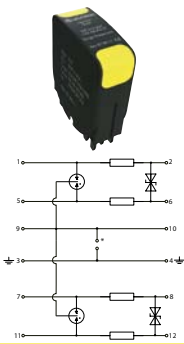

#### Technical Data

Product name	MP 2x2 GDT+5V-Ad-Ad ST	MP 2x2 GDT+12V-Ad-Ad ST	MP 2x2 GDT+24V-Ad-Ad ST	MP 2x2 GDT+36V-Ad-Ad ST
Article-No.	97 00 11	97 00 12	97 00 13	97 00 14
IEC category	D1 / C2 / C1 / C3	D1 / C2 / C1 / C3	D1 / C2 / C1 / C3	D1 / C2 / C1 / C3
Nominal voltage DC	UN 5 V=	12 V=	24 V=	36 V=
Max. continuous operating voltage (DC/AC)	Uc 6/4 V	15/11 V	33/23 V	45/32 V
Nominal current	IL 0,5 A	0,5 A	0,5 A	0,5 A
D1 lightning impulse current (10/350 μs) per line	Iimp 2,5 kA	2,5 kA	2,5 kA	2,5 kA
C2 nominal discharge current (8/20 μs) total	I <sub>max</sub> 20 kA	20 kA	20 kA	20 kA
C2 nominal discharge current (8/20 μs) per line	I <sub>n</sub> 10 kA	10 kA	10 kA	10 kA
Protection level line-line at Iimp D1	Up ≤ 25 V	≤ 26 V	≤ 52 V	≤ 68 V
Protection level line-earth at Iimp D1	Up ≤ 550 V	≤ 550 V	≤ 550 V	≤ 550 V
Protection level line-line at 1 kV/μs C3	Up ≤ 10 V	≤ 19 V	≤ 45 V	≤ 58 V
Protection level line-Pg at 1 kV/μs C3	Up ≤ 500 V	≤ 500 V	≤ 500 V	≤ 500 V
Series resistance per line	Rs 2,2 Ω	2,2 Ω	2,2 Ω	2,2 Ω
Max. frequency (-3 dB)	fG typ. 1,0 MHz	typ. 3,0 MHz	typ. 6,0 MHz	typ. 8,0 MHz
Conductor cross section (solid/stranded/AWG)	0.2-4.0/0.2-2.5 mm <sup>2</sup> / 24-12	0.2-4.0/0.2-2.5 mm <sup>2</sup> / 24-12	0.2-4.0/0.2-2.5 mm <sup>2</sup> / 24-12	0.2-4.0/0.2-2.5 mm <sup>2</sup> / 24-12
Operating temperature range	TU -40 - +80 °C	-40 - +80 °C	-40 - +80 °C	-40 - +80 °C

#### \*Accessories: Plugsocket (Base) for MP 2x2 GDT

	MP Base 2x2-R	MP Base 2x2-R GDT	MP Base 2x2-R GND
Article-No.	97 00 00	97 00 01	97 00 91

Different base parts provide either direct or indirect earthing of the signal: The MP Base 2x2-R is not connected to 9/10 of DIN rail linked (galvanic insulation). The MP Base 2x2-R GDT has a gas discharge tube linked between the connectors 9/10 and

the DIN rail and earth connector. Therefore a galvanic insulation between the signal line and the earth connection (PE) can be reached. The MP Base 2x2-R GND is connected by a bridge to DIN rail (no galvanic insulation).





### MP2x2 2 Double wires 4 Single wires

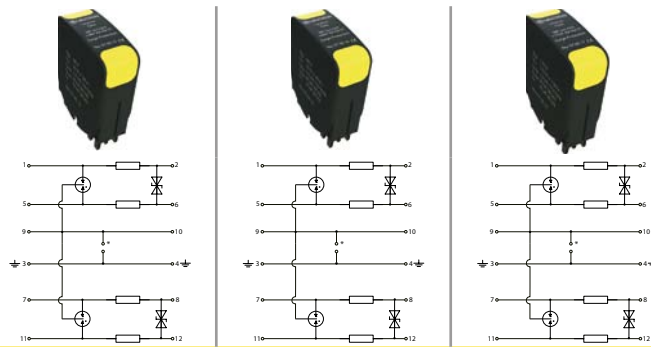

#### Technical Data

Product name	MP 2x2 GDT+48V-Ad-Ad ST	MP 2x2 GDT+60V-Ad-Ad ST	MP 2x2 GDT+170V-Ad-Ad ST
Article-No.	97 00 15	97 00 16	97 00 17
IEC category	D1 / C2 / C1 / C3	D1 / C2 / C1 / C3	D1 / C2 / C1 / C3
Nominal voltage DC	UN 48 V=	60 V=	170 V=
Max. continuous operating voltage (DC/AC)	Uc 50/36 V	70/49 V	170/120 V
Nominal current	IL 0,5 A	0,5 A	0,5 A
D1 lightning impulse current (10/350 μs) per line	Iimp 2,5 kA	2,5 kA	2,5 kA
C2 nominal discharge current (8/20 μs) total	I <sub>max</sub> 20 kA	20 kA	20 kA
C2 nominal discharge current (8/20 μs) per line	I <sub>n</sub> 10 kA	10 kA	10 kA
Protection level line-line at Iimp D1	Up ≤ 80 V	≤ 110 V	≤ 270 V
Protection level line-earth at Iimp D1	Up ≤ 550 V	≤ 550 V	≤ 550 V
Protection level line-line at 1 kV/μs C3	Up ≤ 70 V	≤ 90 V	≤ 250 V
Protection level line-Pg at 1 kV/μs C3	Up ≤ 500 V	≤ 500 V	≤ 500 V
Series resistance per line	Rs 2,2 Ω	2,2 Ω	2,2 Ω
Max. frequency (-3 dB)	fG typ. 10 MHz	typ. 12 MHz	typ. 25 MHz
Conductor cross section (solid/stranded/AWG)	0.2-4.0/0.2-2.5 mm <sup>2</sup> / 24-12	0.2-4.0/0.2-2.5 mm <sup>2</sup> / 24-12	0.2-4.0/0.2-2.5 mm <sup>2</sup> / 24-12
Operating temperature range	TU -40 - +80 °C	-40 - +80 °C	-40 - +80 °C

### MP1x2 1 Double wires 2 Single wires

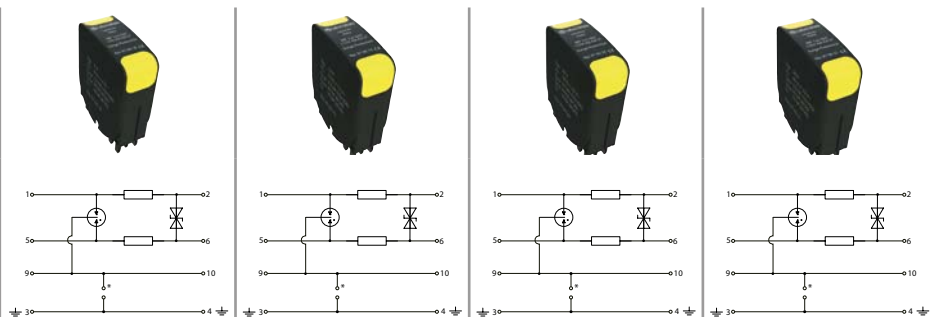

#### Technical Data

Product name	MP 1x2 GDT+5V-Ad-Ad ST	MP 1x2 GDT+12V-Ad-Ad ST	MP 1x2 GDT+24V-Ad-Ad ST	MP 1x2 GDT+36V-Ad-Ad ST
Article-No.	97 00 18	97 00 19	97 00 20	97 00 21
IEC category	D1 / C2 / C1 / C3	D1 / C2 / C1 / C3	D1 / C2 / C1 / C3	D1 / C2 / C1 / C3
Nominal voltage DC	UN 5 V=	12 V=	24 V=	36 V=
Max. continuous operating voltage (DC/AC)	Uc 6/4 V	15/11 V	33/23 V	45/32 V
Nominal current	IL 0,5 A	0,5 A	0,5 A	0,5 A
D1 lightning impulse current (10/350 μs) per line	Iimp 2,5 kA	2,5 kA	2,5 kA	2,5 kA
C2 nominal discharge current (8/20 μs) total	I <sub>max</sub> 20 kA	20 kA	20 kA	20 kA
C2 nominal discharge current (8/20 μs) per line	I <sub>n</sub> 10 kA	10 kA	10 kA	10 kA
Protection level line-line at Iimp D1	Up ≤ 25 V	≤ 26 V	≤ 52 V	≤ 68 V
Protection level line-earth at Iimp D1	Up ≤ 550 V	≤ 550 V	≤ 550 V	≤ 550 V
Protection level line-line at 1 kV/μs C3	Up ≤ 10 V	≤ 19 V	≤ 45 V	≤ 58 V
Protection level line-Pg at 1 kV/μs C3	Up ≤ 500 V	≤ 500 V	≤ 500 V	≤ 500 V
Series resistance per line	Rs 2,2 Ω	2,2 Ω	2,2 Ω	2,2 Ω
Max. frequency (-3 dB)	fG typ. 1,0 MHz	typ. 3,0 MHz	typ. 6,0 MHz	typ. 8,0 MHz
Conductor cross section (solid/stranded/AWG)	0.2-4.0/0.2-2.5 mm <sup>2</sup> / 24-12	0.2-4.0/0.2-2.5 mm <sup>2</sup> / 24-12	0.2-4.0/0.2-2.5 mm <sup>2</sup> / 24-12	0.2-4.0/0.2-2.5 mm <sup>2</sup> / 24-12
Operating temperature range	TU -40 - +80 °C	-40 - +80 °C	-40 - +80 °C	-40 - +80 °C



# SURGE PROTECTION FOR MEASURING SYSTEMS AND AUTOMATIC CONTROL DEVICES

## PLUGGABLE SPD FOR MCR APPLICATIONS

### MP1x2 1 Double wires 2 Single wires

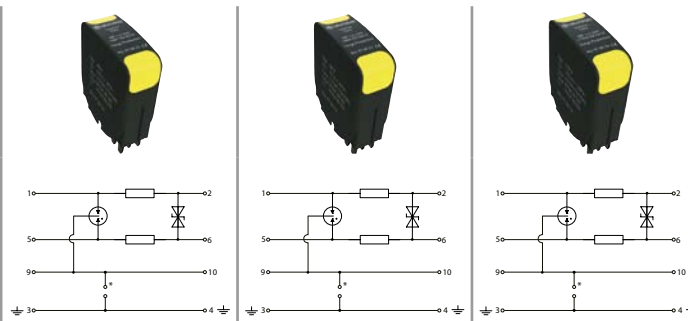

#### Technical Data

Product name	MP 1x2 GDT+48V-Ad-Ad ST	MP 1x2 GDT+60V-Ad-Ad ST	MP 1x2 GDT+170V-Ad-Ad ST
Article-No.	97 00 22	97 00 23	97 00 24
IEC category	D1 / C2 / C1 / C3	D1 / C2 / C1 / C3	D1 / C2 / C1 / C3
Nominal voltage DC	UN 48 V=	60 V=	170 V=
Max. continuous operating voltage (DC/AC)	Uc 50/36 V	70/49 V	170/120 V
Nominal current	IL 0,5 A	0,5 A	0,5 A
D1 lightning impulse current (10/350 μs) per line	Iimp 2,5 kA	2,5 kA	2,5 kA
C2 nominal discharge current (8/20 μs) total	I <sub>max</sub> 20 kA	20 kA	20 kA
C2 nominal discharge current (8/20 μs) per line	I <sub>n</sub> 10 kA	10 kA	10 kA
Protection level line-line at Iimp D1	U <sub>p</sub> ≤ 80 V	≤ 110 V	≤ 270 V
Protection level line-earth at Iimp D1	U <sub>p</sub> ≤ 550 V	≤ 550 V	≤ 550 V
Protection level line-line at 1 kV/μs C3	U <sub>p</sub> ≤ 70 V	≤ 90 V	≤ 250 V
Protection level line-Pg at 1 kV/μs C3	U <sub>p</sub> ≤ 500 V	≤ 500 V	≤ 500 V
Series resistance per line	R <sub>s</sub> 2,2 Ω	2,2 Ω	2,2 Ω
Max. frequency (-3 dB)	f <sub>G</sub> typ. 10 MHz	typ. 12 MHz	typ. 25 MHz
Conductor cross section (solid/stranded/AWG)	0.2-4.0/0.2-2.5 mm <sup>2</sup> / 24-12	0.2-4.0/0.2-2.5 mm <sup>2</sup> / 24-12	0.2-4.0/0.2-2.5 mm <sup>2</sup> / 24-12
Operating temperature range	TU -40 - +80 °C	-40 - +80 °C	-40 - +80 °C

#### \*Accessories: Plug-in socket (Base) for MP 1x2 GDT

	MP Base 1x2-R	MP Base 1x2-R GDT	MP Base 1x2-R GND
Article-No.	97 00 95	97 00 96	97 00 93



Different base parts provide either direct or indirect earthing of the signal: The MP Base 1x2-R is not connected to 9/10 of DIN rail linked (galvanic insulation). The MP Base 1x2-R GDT has a gas discharge tube linked between the connectors 9/10 and

the DIN rail and earth connector. Therefore a galvanic insulation between the signal line and the earth connection (PE) can be reached. The MP Base 1x2-R GND is connected by a bridge to DIN rail (no galvanic insulation).

#### Dimensions

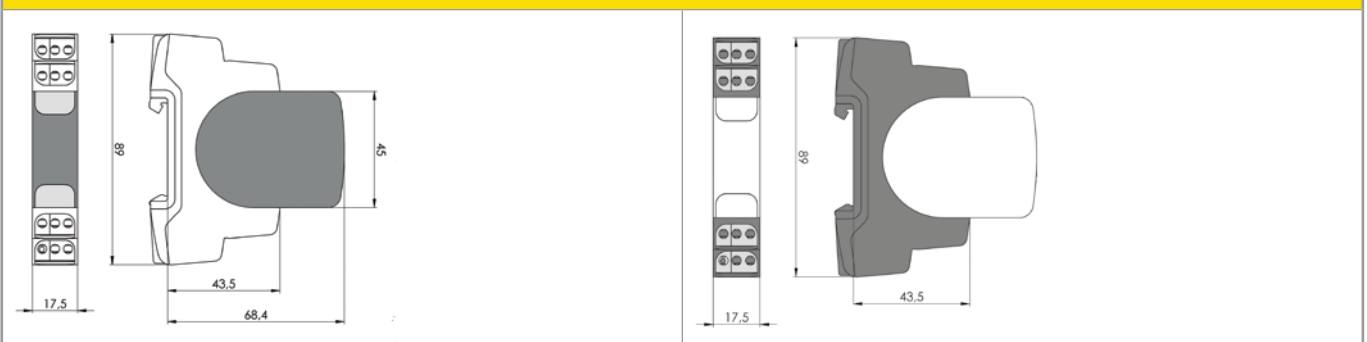



### Pluggable MCR arrester with remote signalling

#### MP 1x2 GDT/Ad-Ad-FM

Fully pluggable two-parts arrester for signal lines with remote signal contact (FM). The protective module can be removed for test or maintenance purposes without changing the line impedance and therefore influencing the signal level. The base part can remain in the installation without manipulating or removing any wire.



image example

- Protective for 1 double or 2 single wires
  - Protective plug can be removed without changing the line impedance or influencing the useful signal
  - Test standard: IEC 61643-21 / EN 61643-21
  - Vibration test standard: DIN EN 60068-2-6, IEC 60068-2-6
  - Shock test standard: DIN EN 60068-2-27, IEC 60068-2-27
  - Mounting on 35 mm DIN rail (EN 60715)
  - Enclosure material: thermoplastic
  - Space required for installation: 17.5 mm
- Applicable at the boundaries LPZ 0A - 1 and higher
  - Degree of protection according to IEC EN 60529: IP 20
  - Inflammability class according to UL 94 V0
  - No additional power supply necessary, saving of costs
  - No additional evaluation unit (controller) necessary
  - Remote signalling contact (FM): changeover contact
  - Switching capacity FM: 1 A/30 VDC // 0,5 A/125 VAC
  - Max. switching voltage FM: 110 V DC / 125 V AC

### MP1x2 1 Double wires 2 Single wires

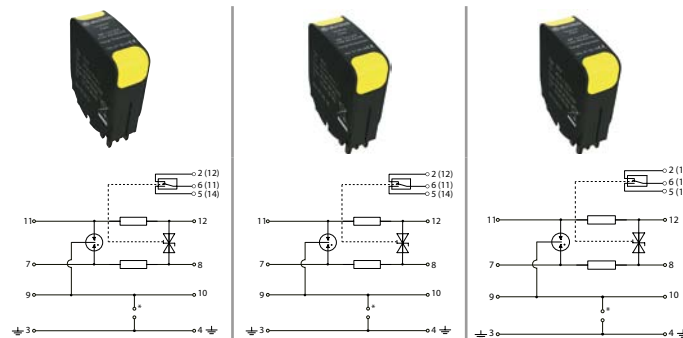

#### Technical Data

Product name	MP 1x2 GDT+12V-Ad-Ad-FM	MP 1x2 GDT+24V-Ad-Ad-FM	MP 1x2 GDT+36V-Ad-Ad-FM
Article-No.	97 00 57	97 00 58	97 00 59
IEC category	D1 / C2 / C1 / C3	D1 / C2 / C1 / C3	D1 / C2 / C1 / C3
Nominal voltage DC	UN 12 V=	24 V=	36 V=
Max. continuous operating voltage (DC/AC)	Uc 15/11 V	33/23 V	45/32 V
Nominal current	IL 0,5 A	0,5 A	0,5 A
D1 lightning impulse current (10/350 µs) per line	Iimp 2,5 kA	2,5 kA	2,5 kA
C2 nominal discharge current (8/20 µs) total	I <sub>max</sub> 20 kA	20 kA	20 kA
C2 nominal discharge current (8/20 µs) per line	I <sub>n</sub> 10 kA	10 kA	10 kA
Protection level line-line at Iimp D1	Up ≤ 26 V	≤ 52 V	≤ 68 V
Protection level line-earth at Iimp D1	Up ≤ 550 V	≤ 550 V	≤ 550 V
Protection level line-line at 1 kV/µs C3	Up ≤ 19 V	≤ 45 V	≤ 58 V
Protection level line-Pg at 1 kV/µs C3	Up ≤ 500 V	≤ 500 V	≤ 500 V
Series resistance per line	R <sub>s</sub> 2,2 Ω	2,2 Ω	2,2 Ω
Max. frequency (-3 dB)	f <sub>G</sub> typ. 3,0 MHz	typ. 6,0 MHz	typ. 8,0 MHz
Conductor cross section (solid/stranded/AWG)	0.2-4.0/0.2-2.5 mm <sup>2</sup> / 24-12	0.2-4.0/0.2-2.5 mm <sup>2</sup> / 24-12	0.2-4.0/0.2-2.5 mm <sup>2</sup> / 24-12
Operating temperature range	TU -40 - +70 °C	-40 - +70 °C	-40 - +70 °C

<b>*Accessories: Plug-in socket (Base) for MP 1x2 GDT-FM</b>	
	MP Base 1x2-R-FM
Article-No.	97 00 06



Plug-in socket with remote signalling contact. The MP base 1x2-R-FM is not connected to 9/10 of DIN rail linked (galvanic insulation).



### Pluggable SPD with high discharge capability and low protection level for MCR applications

#### MP 2x2 GDT/Ad-Pg ST / MP 1x2 GDT/Ad-Pg ST

Plug-in module for consistently pluggable, two-parts arrester for signal lines. The protective module can be removed for test or maintenance purposes without changing the line impedance and therefore influencing the signal level. The base part can remain in the installation without manipulating or removing any wire.



Image example

- Protective for 2 double or 4 single wires at MP 2x2
- Protective for 1 double or 2 single wires at MP 1x2
- Protective plug can be removed without changing the line impedance or influencing the useful signal
- Test standard: IEC 61643-21 / EN 61643-21
- Vibration test standard: DIN EN 60068-2-6, IEC 60068-2-6
- Shock test standard: DIN EN 60068-2-27, IEC 60068-2-27
- Applicable at the boundaries LPZ 0A - 1 and higher
- Mounting on 35 mm DIN rail (EN 60715)
- Enclosure material: thermoplastic
- Space required for installation: 17.5 mm
- Degree of protection according to IEC EN 60529: IP 20
- Inflammability class according to UL 94 V0
- EAC certificated

## MP2x2 2 Double wires 4 Single wires

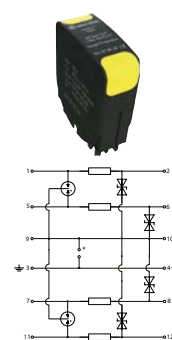
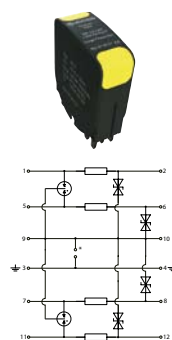
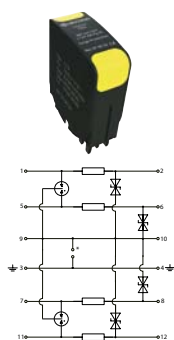
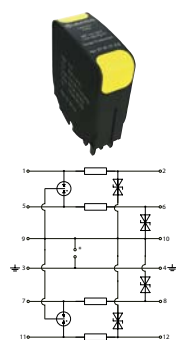

#### Technical Data

Product name	MP 2x2 GDT+5V-Ad-Pg ST	MP 2x2 GDT+12V-Ad-Pg ST	MP 2x2 GDT+24V-Ad-Pg ST	MP 2x2 GDT+36V-Ad-Pg ST
Article-No.	97 00 25	97 00 26	97 00 27	97 00 28
IEC category	D1 / C2 / C1 / C3	D1 / C2 / C1 / C3	D1 / C2 / C1 / C3	D1 / C2 / C1 / C3
Nominal voltage DC	UN 5 V=	12 V=	24 V=	36 V=
Max. continuous operating voltage (DC/AC)	Uc 6/4 V	15/11 V	33/23 V	45/32 V
Nominal current	IL 0,5 A	0,5 A	0,5 A	0,5 A
D1 lightning impulse current (10/350 μs) per line	Iimp 2,5 kA	2,5 kA	2,5 kA	2,5 kA
C2 nominal discharge current (8/20 μs) total	I <sub>max</sub> 20 kA	20 kA	20 kA	20 kA
C2 nominal discharge current (8/20 μs) per line	I <sub>n</sub> 10 kA	10 kA	10 kA	10 kA
Protection level line-line at Iimp D1	Up ≤ 29 V	≤ 50 V	≤ 102 V	≤ 135 V
Protection level line-earth at Iimp D1	Up ≤ 27 V	≤ 37 V	≤ 66 V	≤ 85 V
Protection level line-line at 1 kV/μs C3	Up ≤ 20 V	≤ 38 V	≤ 90 V	≤ 116 V
Protection level line-Pg at 1 kV/μs C3	Up ≤ 10 V	≤ 19 V	≤ 45 V	≤ 58 V
Series resistance per line	Rs 2,2 Ω	2,2 Ω	2,2 Ω	2,2 Ω
Max. frequency (-3 dB)	fG typ. 1,0 MHz	typ. 3,0 MHz	typ. 6,0 MHz	typ. 8,0 MHz
Conductor cross section (solid/stranded/AWG)	0.2-4.0/0.2-2.5 mm <sup>2</sup> / 24-12	0.2-4.0/0.2-2.5 mm <sup>2</sup> / 24-12	0.2-4.0/0.2-2.5 mm <sup>2</sup> / 24-12	0.2-4.0/0.2-2.5 mm <sup>2</sup> / 24-12
Operating temperature range	TU -40 - +80 °C	-40 - +80 °C	-40 - +80 °C	-40 - +80 °C

#### \*Accessories: Plug-in socket (Base) for MP 2x2 GDT

	MP Base 2x2-R	MP Base 2x2-R GDT	MP Base 2x2-R GND
Article-No.	97 00 00	97 00 01	97 00 91

Different base parts provide either direct or indirect earthing of the signal: The MP Base 2x2-R is not connected to 9/10 of DIN rail linked (galvanic insulation). The MP Base 2x2-R GDT has a gas discharge tube linked between the connectors 9/10 and the DIN rail and earth connection.

Therefore a galvanic insulation between the signal line and the earth connection (PE) can be reached. The MP Base 2x2-R GND is connected by a bridge to DIN rail (no galvanic insulation).





### MP2x2 2 Double wires 4 Single wires

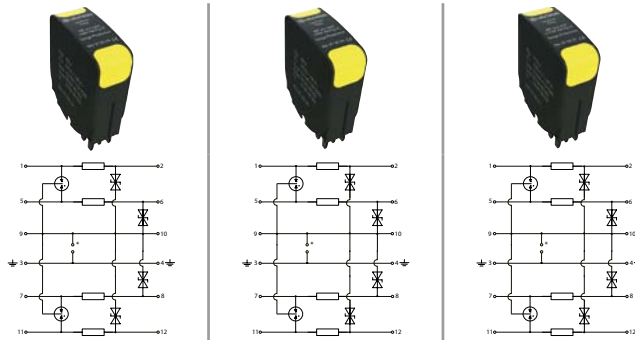

#### Technical Data

Product name	MP 2x2 GDT+48V-Ad-Pg ST	MP 2x2 GDT+60V-Ad-Pg ST	MP 2x2 GDT+170V-Ad-Pg ST
Article-No.	97 00 29	97 00 30	97 00 31
IEC category	D1 / C2 / C1 / C3	D1 / C2 / C1 / C3	D1 / C2 / C1 / C3
Nominal voltage DC	UN 48 V=	60 V=	170 V=
Max. continuous operating voltage (DC/AC)	Uc 50/36 V	70/49 V	170/120 V
Nominal current	IL 0,5 A	0,5 A	0,5 A
D1 lightning impulse current (10/350 μs) per line	limp 2,5 kA	2,5 kA	2,5 kA
C2 nominal discharge current (8/20 μs) total	Imax 20 kA	20 kA	20 kA
C2 nominal discharge current (8/20 μs) per line	In 10 kA	10 kA	10 kA
Protection level line-line at limp D1	Up ≤ 160 V	≤ 220 V	≤ 520 V
Protection level line-earth at limp D1	Up ≤ 95 V	≤ 125 V	≤ 300 V
Protection level line-line at 1 kV/μs C3	Up ≤ 140 V	≤ 180 V	≤ 500 V
Protection level line-Pg at 1 kV/μs C3	Up ≤ 70 V	≤ 90 V	≤ 250 V
Series resistance per line	Rs 2,2 Ω	2,2 Ω	2,2 Ω
Max. frequency (-3 dB)	fG typ. 10 MHz	typ. 12 MHz	typ. 25 MHz
Conductor cross section (solid/stranded/AWG)	0.2-4.0/0.2-2.5 mm <sup>2</sup> / 24-12	0.2-4.0/0.2-2.5 mm <sup>2</sup> / 24-12	0.2-4.0/0.2-2.5 mm <sup>2</sup> / 24-12
Operating temperature range	TU -40 - +80 °C	-40 - +80 °C	-40 - +80 °C

### MP1x2 1 Double wires 2 Single wires

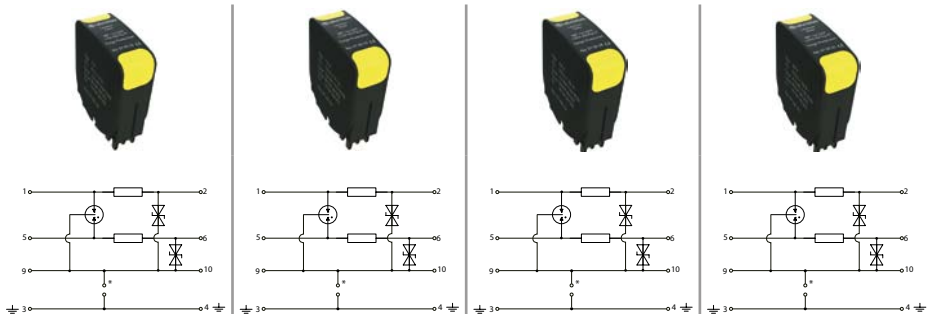

#### Technical Data

Product name	MP 1x2 GDT+5V-Ad-Pg ST	MP 1x2 GDT+12V-Ad-Pg ST	MP 1x2 GDT+24V-Ad-Pg ST	MP 1x2 GDT+36V-Ad-Pg ST
Article-No.	97 00 32	97 00 33	97 00 34	97 00 35
IEC category	D1 / C2 / C1 / C3	D1 / C2 / C1 / C3	D1 / C2 / C1 / C3	D1 / C2 / C1 / C3
Nominal voltage DC	UN 5 V=	12 V=	24 V=	36 V=
Max. continuous operating voltage (DC/AC)	Uc 6/4 V	15/11 V	33/23 V	45/32 V
Nominal current	IL 0,5 A	0,5 A	0,5 A	0,5 A
D1 lightning impulse current (10/350 μs) per line	limp 2,5 kA	2,5 kA	2,5 kA	2,5 kA
C2 nominal discharge current (8/20 μs) total	Imax 20 kA	20 kA	20 kA	20 kA
C2 nominal discharge current (8/20 μs) per line	In 10 kA	10 kA	10 kA	10 kA
Protection level line-line at limp D1	Up ≤ 29 V	≤ 50 V	≤ 102 V	≤ 135 V
Protection level line-earth at limp D1	Up ≤ 27 V	≤ 37 V	≤ 66 V	≤ 85 V
Protection level line-line at 1 kV/μs C3	Up ≤ 20 V	≤ 38 V	≤ 90 V	≤ 116 V
Protection level line-Pg at 1 kV/μs C3	Up ≤ 10 V	≤ 19 V	≤ 45 V	≤ 58 V
Series resistance per line	Rs 2,2 Ω	2,2 Ω	2,2 Ω	2,2 Ω
Max. frequency (-3 dB)	fG typ. 1,0 MHz	typ. 3,0 MHz	typ. 6,0 MHz	typ. 8,0 MHz
Conductor cross section (solid/stranded/AWG)	0.2-4.0/0.2-2.5 mm <sup>2</sup> / 24-12	0.2-4.0/0.2-2.5 mm <sup>2</sup> / 24-12	0.2-4.0/0.2-2.5 mm <sup>2</sup> / 24-12	0.2-4.0/0.2-2.5 mm <sup>2</sup> / 24-12
Operating temperature range	TU -40 - +80 °C	-40 - +80 °C	-40 - +80 °C	-40 - +80 °C



# SURGE PROTECTION FOR MEASURING SYSTEMS AND AUTOMATIC CONTROL DEVICES

## PLUGGABLE SPD FOR MCR APPLICATIONS

### MP1x2 1 Double wires 2 Single wires

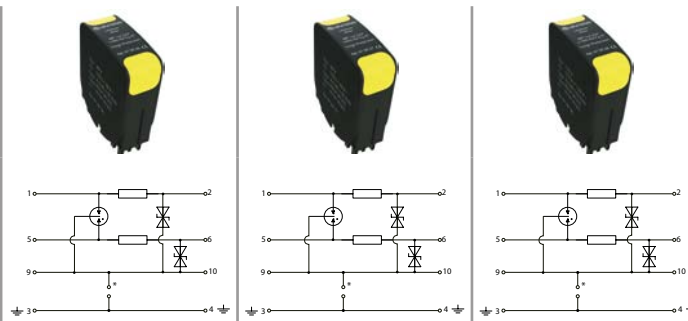

#### Technical Data

Product name	MP 1x2 GDT+48V-Ad-Pg ST	MP 1x2 GDT+60V-Ad-Pg ST	MP 1x2 GDT+170V-Ad-Pg ST
Article-No.	97 00 36	97 00 37	97 00 38
IEC category	D1 / C2 / C1 / C3	D1 / C2 / C1 / C3	D1 / C2 / C1 / C3
Nominal voltage DC	UN 48 V=	60 V=	170 V=
Max. continuous operating voltage (DC/AC)	Uc 50/36 V	70/49 V	170/120 V
Nominal current	IL 0,5 A	0,5 A	0,5 A
D1 lightning impulse current (10/350 μs) per line	limp 2,5 kA	2,5 kA	2,5 kA
C2 nominal discharge current (8/20 μs) total	Imax 20 kA	20 kA	20 kA
C2 nominal discharge current (8/20 μs) per line	In 10 kA	10 kA	10 kA
Protection level line-line at limp D1	Up ≤ 160 V	≤ 220 V	≤ 520 V
Protection level line-earth at limp D1	Up ≤ 95 V	≤ 125 V	≤ 300 V
Protection level line-line at 1 kV/μs C3	Up ≤ 140 V	≤ 180 V	≤ 500 V
Protection level line-Pg at 1 kV/μs C3	Up ≤ 70 V	≤ 90 V	≤ 250 V
Series resistance per line	Rs 2,2 Ω	2,2 Ω	2,2 Ω
Max. frequency (-3 dB)	fG typ. 10 MHz	typ. 12 MHz	typ. 25 MHz
Conductor cross section (solid/stranded/AWG)	0.2-4.0/0.2-2.5 mm <sup>2</sup> / 24-12	0.2-4.0/0.2-2.5 mm <sup>2</sup> / 24-12	0.2-4.0/0.2-2.5 mm <sup>2</sup> / 24-12
Operating temperature range	TU -40 - +80 °C	-40 - +80 °C	-40 - +80 °C

#### \*Accessories: Plug-in socket (Base) for MP 1x2 GDT

	MP Base 1x2-R	MP Base 1x2-R GDT	MP Base 1x2-R GND
Article-No.	97 00 95	97 00 96	97 00 93



Different base parts provide either direct or indirect earthing of the signal: The MP Base 1x2-R is not connected to 9/10 of DIN rail linked (galvanic insulation). The MP Base 1x2-R GDT has a gas discharge tube linked between the connectors 9/10 and

the DIN rail and earth connector. Therefore a galvanic insulation between the signal line and the earth connection (PE) can be reached. The MP Base 1x2-R GND is connected by a bridge to DIN rail (no galvanic insulation).

#### Dimensions

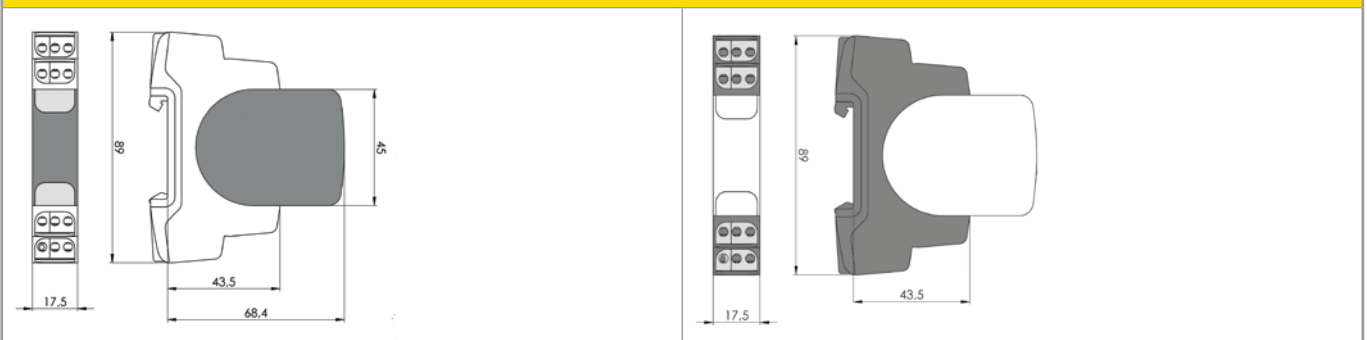





### Pluggable SPD with high discharge capability and low protection level for MCR applications

#### MP 2x2 GDT/Ad-Ad-Pg ST / MP 1x2 GDT/Ad-Ad-Pg ST

Fully pluggable two-parts arrester for signal lines. The protective module can be removed for test or maintenance purposes without changing the line impedance and therefore influencing the signal level. The base part can remain in the installation without manipulating or removing any wire.



image example

- Protective for 2 double or 4 single wires bei MP 2x2
- Protective for 1 double or 2 single wires bei MP 1x2
- Protective plug can be removed without changing the line impedance or influencing the useful signal
- Test standard: IEC 61643-21 / EN 61643-21
- Vibration test standard: DIN EN 60068-2-6, IEC 60068-2-6
- Shock test standard: DIN EN 60068-2-27, IEC 60068-2-27
- Applicable at the boundaries LPZ 0A - 2 and higher
- Mounting on 35 mm DIN rail (EN 60715)
- Enclosure material: thermoplastic
- Space required for installation: 17.5 mm
- Degree of protection according to IEC EN 60529: IP 20
- Inflammability class according to UL 94 V0
- EAC certificated

## MP2x2 2 Double wires 4 Single wires

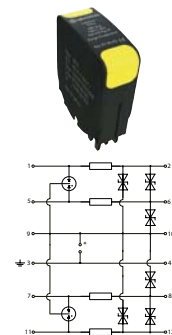
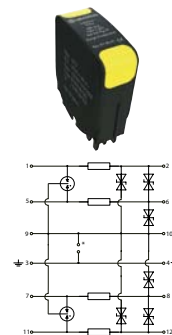
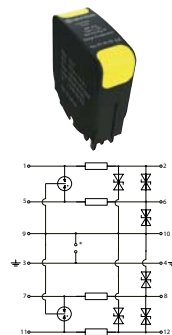
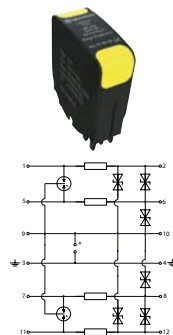

#### Technical Data

Product name	MP 2x2 GDT+5V-Ad-Ad-Pg ST	MP 2x2 GDT+12V-Ad-Ad-Pg ST	MP 2x2 GDT+24V-Ad-Ad-Pg ST	MP 2x2 GDT+36V-Ad-Ad-Pg ST
Article-No.	97 00 39	97 00 40	97 00 41	97 00 42
IEC category	D1 / C2 / C1 / C3	D1 / C2 / C1 / C3	D1 / C2 / C1 / C3	D1 / C2 / C1 / C3
Nominal voltage DC	UN 5 V=	12 V=	24 V=	36 V=
Max. continuous operating voltage (DC/AC)	Uc 6/4 V	15/11 V	33/23 V	45/32 V
Nominal current	IL 0,5 A	0,5 A	0,5 A	0,5 A
D1 lightning impulse current (10/350 μs) per line	Iimp 2,5 kA	2,5 kA	2,5 kA	2,5 kA
C2 nominal discharge current (8/20 μs) total	I <sub>max</sub> 20 kA	20 kA	20 kA	20 kA
C2 nominal discharge current (8/20 μs) per line	I <sub>n</sub> 10 kA	10 kA	10 kA	10 kA
Protection level line-line at Iimp D1	Up ≤ 25 V	≤ 26 V	≤ 52 V	≤ 68 V
Protection level line-earth at Iimp D1	Up ≤ 27 V	≤ 37 V	≤ 66 V	≤ 85 V
Protection level line-line at 1 kV/μs C3	Up ≤ 10 V	≤ 19 V	≤ 45 V	≤ 58 V
Protection level line-Pg at 1 kV/μs C3	Up ≤ 10 V	≤ 19 V	≤ 45 V	≤ 58 V
Series resistance per line	Rs 2,2 Ω	2,2 Ω	2,2 Ω	2,2 Ω
Max. frequency (-3 dB)	fG typ. 1,0 MHz	typ. 3,0 MHz	typ. 6,0 MHz	typ. 8,0 MHz
Conductor cross section (solid/stranded/AWG)	0.2-4.0/0.2-2.5 mm <sup>2</sup> / 24-12	0.2-4.0/0.2-2.5 mm <sup>2</sup> / 24-12	0.2-4.0/0.2-2.5 mm <sup>2</sup> / 24-12	0.2-4.0/0.2-2.5 mm <sup>2</sup> / 24-12
Operating temperature range	TU -40 - +80 °C	-40 - +80 °C	-40 - +80 °C	-40 - +80 °C



# SURGE PROTECTION FOR MEASURING SYSTEMS AND AUTOMATIC CONTROL DEVICES

## PLUGGABLE SPD FOR MCR APPLICATIONS

### MP2x2 2 Double wires 4 Single wires

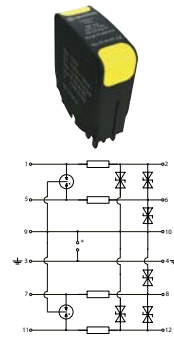
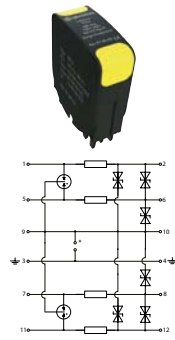
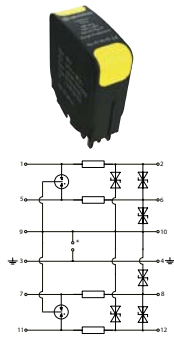

#### Technical Data

Product name	MP 2x2 GDT+48V-Ad-Ad-Pg ST	MP 2x2 GDT+60V-Ad-Ad-Pg ST	MP 2x2 GDT+170V-Ad-Ad-Pg ST
Article-No.	97 00 43	97 00 44	97 00 45
IEC category	D1 / C2 / C1 / C3	D1 / C2 / C1 / C3	D1 / C2 / C1 / C3
Nominal voltage DC	UN 48 V=	60 V=	170 V=
Max. continuous operating voltage (DC/AC)	Uc 50/36 V	70/49 V	170/120 V
Nominal current	IL 0,5 A	0,5 A	0,5 A
D1 lightning impulse current (10/350 µs) per line	limp 2,5 kA	2,5 kA	2,5 kA
C2 nominal discharge current (8/20 µs) total	Imax 20 kA	20 kA	20 kA
C2 nominal discharge current (8/20 µs) per line	In 10 kA	10 kA	10 kA
Protection level line-line at limp D1	Up ≤ 80 V	≤ 110 V	≤ 270 V
Protection level line-earth at limp D1	Up ≤ 95 V	≤ 125 V	≤ 300 V
Protection level line-line at 1 kV/µs C3	Up ≤ 70 V	≤ 90 V	≤ 250 V
Protection level line-Pg at 1 kV/µs C3	Up ≤ 70 V	≤ 90 V	≤ 250 V
Series resistance per line	Rs 2,2 Ω	2,2 Ω	2,2 Ω
Max. frequency (-3 dB)	fG typ. 10 MHz	typ. 12 MHz	typ. 25 MHz
Conductor cross section (solid/stranded/AWG)	0.2-4.0/0.2-2.5 mm <sup>2</sup> / 24-12	0.2-4.0/0.2-2.5 mm <sup>2</sup> / 24-12	0.2-4.0/0.2-2.5 mm <sup>2</sup> / 24-12
Operating temperature range	TU -40 - +80 °C	-40 - +80 °C	-40 - +80 °C

#### \*Accessories: Plugsocket (Base) for MP 2x2 GDT

	MP Base 2x2-R	MP Base 2x2-R GDT	MP Base 2x2-R GND
Article-No.	97 00 00	97 00 01	97 00 91



Different base parts provide either direct or indirect earthing of the signal: The MP Base 2x2-R is not connected to 9/10 of DIN rail linked (galvanic insulation). The MP Base 2x2-R GDT has a gas discharge tube linked between the connectors 9/10 and

the DIN rail and earth connector. Therefore a galvanic insulation between the signal line and the earth connection (PE) can be reached. The MP Base 2x2-R GND is connected by a bridge to DIN rail (no galvanic insulation).

#### Dimensions

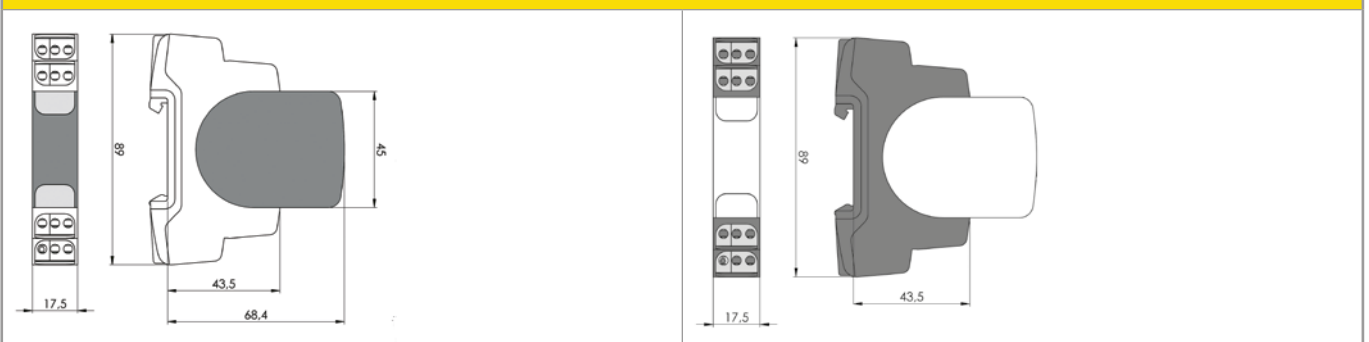



### MP1x2 1 Double wires 2 Single wires

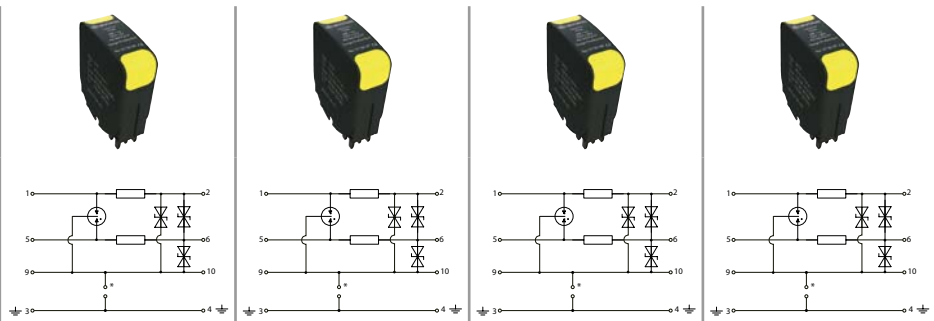

#### Technical Data

Product name	MP 1x2 GDT+5V-Ad-Ad-Pg ST	MP 1x2 GDT+12V-Ad-Ad-Pg ST	MP 1x2 GDT+24V-Ad-Ad-Pg ST	MP 1x2 GDT+36V-Ad-Ad-Pg ST
Article-No.	97 00 46	97 00 47	97 00 48	97 00 49
IEC category	D1 / C2 / C1 / C3	D1 / C2 / C1 / C3	D1 / C2 / C1 / C3	D1 / C2 / C1 / C3
Nominal voltage DC	UN 5 V=	12 V=	24 V=	36 V=
Max. continuous operating voltage (DC/AC)	Uc 6/4 V	15/11 V	33/23 V	45/32 V
Nominal current	IL 0,5 A	0,5 A	0,5 A	0,5 A
D1 lightning impulse current (10/350 µs) per line	Iimp 2,5 kA	2,5 kA	2,5 kA	2,5 kA
C2 nominal discharge current (8/20 µs) total	I <sub>max</sub> 20 kA	20 kA	20 kA	20 kA
C2 nominal discharge current (8/20 µs) per line	I <sub>n</sub> 10 kA	10 kA	10 kA	10 kA
Protection level line-line at Iimp D1	Up ≤ 25 V	≤ 26 V	≤ 52 V	≤ 68 V
Protection level line-earth at Iimp D1	Up ≤ 27 V	≤ 37 V	≤ 66 V	≤ 85 V
Protection level line-line at 1 kV/µs C3	Up ≤ 10 V	≤ 19 V	≤ 45 V	≤ 58 V
Protection level line-Pg at 1 kV/µs C3	Up ≤ 10 V	≤ 19 V	≤ 45 V	≤ 58 V
Series resistance per line	Rs 2,2 Ω	2,2 Ω	2,2 Ω	2,2 Ω
Max. frequency (-3 dB)	fG typ. 1,0 MHz	typ. 3,0 MHz	typ. 6,0 MHz	typ. 8,0 MHz
Conductor cross section (solid/stranded/AWG)	0.2-4.0/0.2-2.5 mm <sup>2</sup> / 24-12	0.2-4.0/0.2-2.5 mm <sup>2</sup> / 24-12	0.2-4.0/0.2-2.5 mm <sup>2</sup> / 24-12	0.2-4.0/0.2-2.5 mm <sup>2</sup> / 24-12
Operating temperature range	TU -40 - +80 °C	-40 - +80 °C	-40 - +80 °C	-40 - +80 °C

### MP1x2 1 Double wires 2 Single wires

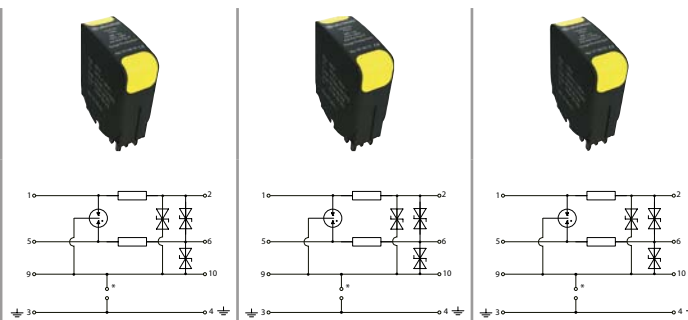

#### Technical Data

Product name	MP 1x2 GDT+48V-Ad-Ad-Pg ST	MP 1x2 GDT+60V-Ad-Ad-Pg ST	MP 1x2 GDT+170V-Ad-Ad-Pg ST
Article-No.	97 00 50	97 00 51	97 00 52
IEC category	D1 / C2 / C1 / C3	D1 / C2 / C1 / C3	D1 / C2 / C1 / C3
Nominal voltage DC	UN 48 V=	60 V=	170 V=
Max. continuous operating voltage (DC/AC)	Uc 50/36 V	70/49 V	170/120 V
Nominal current	IL 0,5 A	0,5 A	0,5 A
D1 lightning impulse current (10/350 µs) per line	Iimp 2,5 kA	2,5 kA	2,5 kA
C2 nominal discharge current (8/20 µs) total	I <sub>max</sub> 20 kA	20 kA	20 kA
C2 nominal discharge current (8/20 µs) per line	I <sub>n</sub> 10 kA	10 kA	10 kA
Protection level line-line at Iimp D1	Up ≤ 80 V	≤ 110 V	≤ 270 V
Protection level line-earth at Iimp D1	Up ≤ 95 V	≤ 125 V	≤ 300 V
Protection level line-line at 1 kV/µs C3	Up ≤ 70 V	≤ 90 V	≤ 250 V
Protection level line-Pg at 1 kV/µs C3	Up ≤ 70 V	≤ 90 V	≤ 250 V
Series resistance per line	Rs 2,2 Ω	2,2 Ω	2,2 Ω
Max. frequency (-3 dB)	fG typ. 10 MHz	typ. 12 MHz	typ. 25 MHz
Conductor cross section (solid/stranded/AWG)	0.2-4.0/0.2-2.5 mm <sup>2</sup> / 24-12	0.2-4.0/0.2-2.5 mm <sup>2</sup> / 24-12	0.2-4.0/0.2-2.5 mm <sup>2</sup> / 24-12
Operating temperature range	TU -40 - +80 °C	-40 - +80 °C	-40 - +80 °C



# SURGE PROTECTION FOR MEASURING SYSTEMS AND AUTOMATIC CONTROL DEVICES

## PLUGGABLE SPD FOR MCR APPLICATIONS

### \*Accessories: Plug-in socket (Base) for MP 1x2 GDT

	MP Base 1x2-R	MP Base 1x2-R GDT	MP Base 1x2-R GND
Article-No.	97 00 95	97 00 96	97 00 93

Different base parts provide either direct or indirect earthing of the signal: The MP Base 1x2-R is not connected to 9/10 of DIN rail linked (galvanic insulation). The MP Base 1x2-R GDT has a gas discharge tube linked between the connectors 9/10 and

the DIN rail and earth connector. Therefore a galvanic insulation between the signal line and the earth connection (PE) can be reached. The MP Base 1x2-R GND is connected by a bridge to DIN rail (no galvanic insulation).



### Dimensions

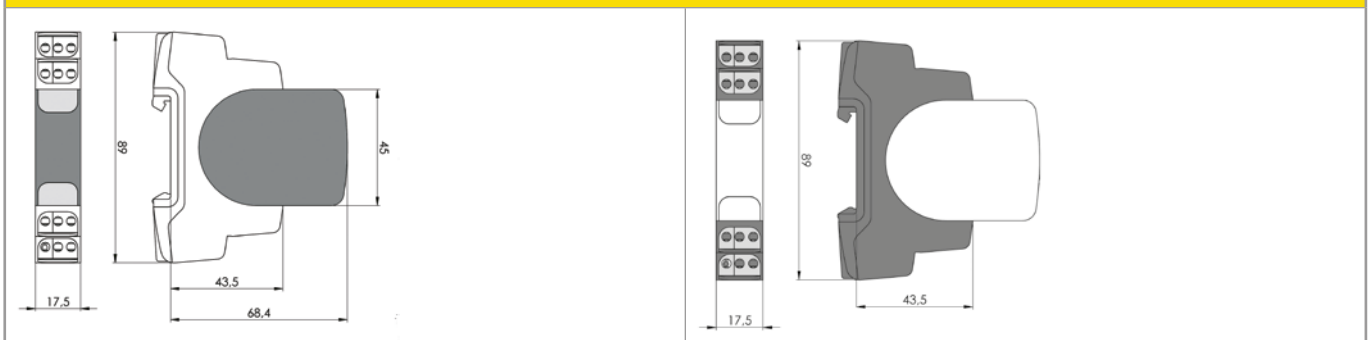



### Pluggable SPD for high frequency MCR applications

#### MP 2x2 HF ST / MP 1x2 HF ST

Plug-in module for consistently pluggable two-parts arrester for signal lines for high frequency applications such as bus systems or video transmission. The protective module can be removed for test or maintenance purposes without changing the line impedance and therefore influencing the signal level. The base part can remain in the installation without manipulating or removing any wire.

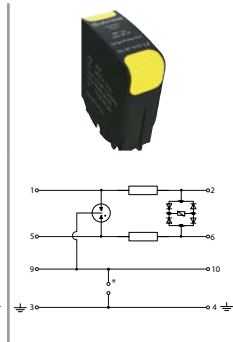
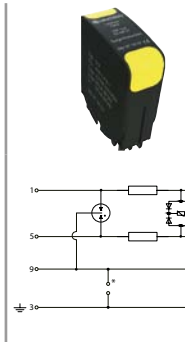
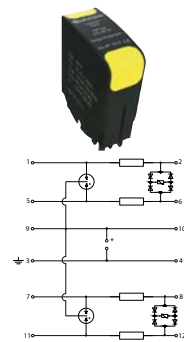
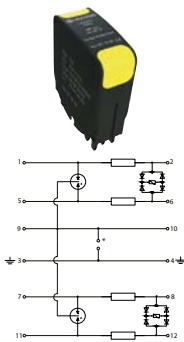

image example

- Max. frequency 70 MHz
- Nominal current 0,5 A
- Protective for 2 double or 4 single wires bei MP 2x2
- Protective for 1 double or 2 single wires bei MP 1x2
- Test standard: IEC 61643-21 / EN 61643-21
- Vibration test standard: DIN EN 60068-2-6, IEC 60068-2-6
- Shock test standard: DIN EN 60068-2-27, IEC 60068-2-27
- Mounting on 35 mm DIN rail (EN 60715)
- Enclosure material: thermoplastic
- Space required for installation: 17.5 mm
- Applicable at the boundaries LPZ 0A - 1 and higher
- Degree of protection according to IEC EN 60529: IP 20
- Inflammability class according to UL 94 V0
- EAC certificated

**MP2x2** 2 Double wires  
4 Single wires

**MP1x2** 1 Double wires  
2 Single wires



#### Technical Data

Product name	MP 2x2 5V-HF ST	MP 2x2 24V-HF ST	MP 1x2 5V-HF ST	MP 1x2 24V-HF ST
Article-No.	97 10 50	97 10 51	97 10 52	97 10 53
IEC category	D1 / C2 / C1 / C3	D1 / C2 / C1 / C3	D1 / C2 / C1 / C3	D1 / C2 / C1 / C3
Nominal voltage DC	UN 5 V=	24 V=	5 V=	24 V=
Max. continuous operating voltage (DC/AC)	Uc 6/4 V	33/23 V	6/4 V	33/23 V
Nominal current	IL 0,5 A	0,5 A	0,5 A	0,5 A
D1 lightning impulse current (10/350 μs) per line	Iimp 2,5 kA	2,5 kA	2,5 kA	2,5 kA
C2 nominal discharge current (8/20 μs) total	I <sub>max</sub> 20 kA	20 kA	20 kA	20 kA
C2 nominal discharge current (8/20 μs) per line	I <sub>n</sub> 10 kA	10 kA	10 kA	10 kA
Protection level line-line at Iimp D1	Up ≤ 25 V	≤ 52 V	≤ 25 V	≤ 52 V
Protection level line-earth at Iimp D1	Up ≤ 350 V	≤ 350 V	≤ 350 V	≤ 350 V
Protection level line-line at 1 kV/μs C3	Up ≤ 10 V	≤ 45 V	≤ 10 V	≤ 45 V
Protection level line-Pg at 1 kV/μs C3	Up ≤ 450 V	≤ 450 V	≤ 450 V	≤ 450 V
Series resistance per line	Rs 1,5 Ω	1,5 Ω	1,5 Ω	1,5 Ω
Max. frequency (-3 dB)	fG typ. 70 MHz	typ. 70 MHz	typ. 70 MHz	typ. 70 MHz
Conductor cross section (solid/stranded/AWG)	0.2-4.0/0.2-2.5 mm <sup>2</sup> / 24-12	0.2-4.0/0.2-2.5 mm <sup>2</sup> / 24-12	0.2-4.0/0.2-2.5 mm <sup>2</sup> / 24-12	0.2-4.0/0.2-2.5 mm <sup>2</sup> / 24-12
Operating temperature range	TU -40 - +80 °C	-40 - +80 °C	-40 - +80 °C	-40 - +80 °C

Accessories: Plug-in socket (Base)	MP 2x2-HF ST			MP 1x2-HF ST		
	MP Base 2x2-R HF	MP Base 2x2-R GDT HF	MP Base 2x2-R GND HF	MP Base 1x2-R HF	MP Base 1x2-R GDT HF	MP Base 1x2-R GND HF
Article-No.	97 00 99	97 01 00	97 01 01	97 01 02	97 01 03	97 01 04

Different base parts provide either direct or indirect earthing of the signal: The MP Base 2x2-R HF (1x2-R HF) is not connected to 9/10 of DIN rail linked (galvanic insulation). The MP Base 2x2-R HF (1x2-R HF) GDT has a gas discharge tube linked between the connectors 9/10 and the DIN rail

and earth connector. Therefore a galvanic insulation between the signal line and the earth connection (PE) can be reached. The MP Base 2x2-R HF (1x2-R HF) GND is connected by a bridge to DIN rail (no galvanic insulation).





### Pluggable SPD for high frequency MCR applications

#### MP 2x2-170-HF ST / MP 1x2-170 HF ST

Plug-in module for consistently pluggable two-parts arrester for signal lines for high frequency applications such as bus systems or video transmission. The protective module can be removed for test or maintenance purposes without changing the line impedance and therefore influencing the signal level. The base part can remain in the installation without manipulating or removing any wire.

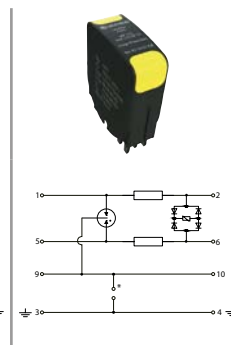
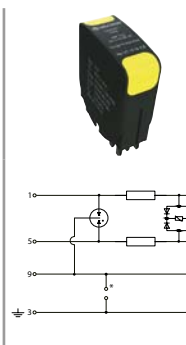
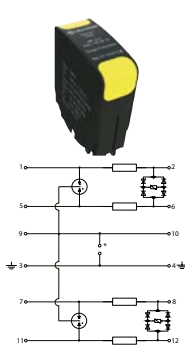
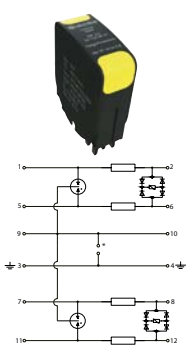

image example

- Max. frequency 170 MHz
- Nominal current: 1A
- Protective for 2 double or 4 single wires bei MP 2x2
- Protective for 1 double or 2 single wires bei MP 1x2
- Test standard: IEC 61643-21 / EN 61643-21
- Vibration test standard: DIN EN 60068-2-6, IEC 60068-2-6
- Shock test standard: DIN EN 60068-2-27, IEC 60068-2-27
- Mounting on 35 mm DIN rail (EN 60715)
- Enclosure material: thermoplastic
- Space required for installation: 17.5 mm
- Applicable at the boundaries LPZ 0A - 1 and higher
- Degree of protection according to IEC EN 60529: IP 20
- Inflammability class according to UL 94 V0
- EAC certificated

**MP2x2** 2 Double wires  
4 Single wires

**MP1x2** 1 Double wires  
2 Single wires



#### Technical Data

Product name	MP 2x2 5V-170-HF ST	MP 2x2 24V-170-HF ST	MP 1x2 5V-170-HF ST	MP 1x2 24V-170-HF ST
Article-No.	97 10 54	97 10 55	97 10 56	97 10 57
IEC category	D1 / C2 / C1 / C3			
Nominal voltage DC	UN 5 V=	24 V=	5 V=	24 V=
Max. continuous operating voltage (DC/AC)	Uc 6/4 V	33/23 V	6/4 V	33/23 V
Nominal current	IL 1 A	1 A	1 A	1 A
D1 lightning impulse current (10/350 μs) per line	Iimp 2,5 kA	2,5 kA	2,5 kA	2,5 kA
C2 nominal discharge current (8/20 μs) total	I <sub>max</sub> 20 kA	20 kA	20 kA	20 kA
C2 nominal discharge current (8/20 μs) per line	I <sub>n</sub> 10 kA	10 kA	10 kA	10 kA
Protection level line-line at Iimp D1	Up ≤ 25 V	≤ 52 V	≤ 25 V	≤ 52 V
Protection level line-earth at Iimp D1	Up ≤ 350 V	≤ 350 V	≤ 350 V	≤ 350 V
Protection level line-line at 1 kV/μs C3	Up ≤ 10 V	≤ 45 V	≤ 10 V	≤ 45 V
Protection level line-Pg at 1 kV/μs C3	Up ≤ 450 V	≤ 450 V	≤ 450 V	≤ 450 V
Series resistance per line	Rs 1,5 Ω	1,5 Ω	1,5 Ω	1,5 Ω
Max. frequency (-3 dB)	fG typ. 170 MHz	typ. 170 MHz	typ. 170 MHz	typ. 170 MHz
Conductor cross section (solid/stranded/AWG)	0.2-4.0/0.2-2.5 mm <sup>2</sup> / 24-12	0.2-4.0/0.2-2.5 mm <sup>2</sup> / 24-12	0.2-4.0/0.2-2.5 mm <sup>2</sup> / 24-12	0.2-4.0/0.2-2.5 mm <sup>2</sup> / 24-12
Operating temperature range	TU -40 - +80 °C	-40 - +80 °C	-40 - +80 °C	-40 - +80 °C

*Accessories: Plug-in socket (Base)	MP 2x2-170 HF ST			MP 1x2-170 HF ST		
	MP Base 2x2-R HF	MP Base 2x2-R GDT HF	MP Base 2x2-R GND HF	MP Base 1x2-R HF	MP Base 1x2-R GDT HF	MP Base 1x2-R GND HF
Article-No.	97 00 99	97 01 00	97 01 01	97 01 02	97 01 03	97 01 04

Different base parts provide either direct or indirect earthing of the signal: The MP Base 2x2-R HF (1x2-R HF) is not connected to 9/10 of DIN rail linked (galvanic insulation). The MP Base 2x2-R HF (1x2-R HF) GDT has a gas discharge tube linked between the connectors 9/10 and the DIN rail

and earth connector. Therefore a galvanic insulation between the signal line and the earth connection (PE) can be reached. The MP Base 2x2-R HF (1x2-R HF) GND is connected by a bridge to DIN rail (no galvanic insulation).





### Allocation of MP modules to plug-in sockets (MP Base)

Art.-No.	Product name module	Plug-in socket
97 00 07	MP 2x2 GDT-Ad-Ad-Pg ST	970003 MP Base 2x2 or 970004 MP Base 2x2 GDT or 970092 MP Base 2x2 GND
97 00 10	MP 1x2 GDT-Ad-Ad-Pg ST	970097 MP Base 1x2 or 970098 MP Base 1x2 GDT or 970094 MP Base 1x2 GND
97 00 11	MP 2x2 GDT+5V-Ad-Ad ST	970000 MP Base 2x2-R or 970001 MP Base 2x2-R GDT or 970091 MP Base 2x2-R GND
97 00 12	MP 2x2 GDT+12V-Ad-Ad ST	
97 00 13	MP 2x2 GDT+24V-Ad-Ad ST	
97 00 14	MP 2x2 GDT+36V-Ad-Ad ST	
97 00 15	MP 2x2 GDT+48V-Ad-Ad ST	
97 00 16	MP 2x2 GDT+60V-Ad-Ad ST	
97 00 17	MP 2x2 GDT+170V-Ad-Ad ST	
97 00 18	MP 1x2 GDT+5V-Ad-Ad ST	970095 MP Base 1x2-R or 970096 MP Base 1x2-R GDT or 970093 MP Base 1x2-R GND
97 00 19	MP 1x2 GDT+12V-Ad-Ad ST	
97 00 20	MP 1x2 GDT+24V-Ad-Ad ST	
97 00 21	MP 1x2 GDT+36V-Ad-Ad ST	
97 00 22	MP 1x2 GDT+48V-Ad-Ad ST	
97 00 23	MP 1x2 GDT+60V-Ad-Ad ST	
97 00 24	MP 1x2 GDT+170V-Ad-Ad ST	
97 00 25	MP 2x2 GDT+5V-Ad-Pg ST	970000 MP Base 2x2-R or 970001 MP Base 2x2-R GDT or 970091 MP Base 2x2-R GND
97 00 26	MP 2x2 GDT+12V-Ad-Pg ST	
97 00 27	MP 2x2 GDT+24V-Ad-Pg ST	
97 00 28	MP 2x2 GDT+36V-Ad-Pg ST	
97 00 29	MP 2x2 GDT+48V-Ad-Pg ST	
97 00 30	MP 2x2 GDT+60V-Ad-Pg ST	
97 00 31	MP 2x2 GDT+170V-Ad-Pg ST	
97 00 32	MP 1x2 GDT+5V-Ad-Pg ST	970095 MP Base 1x2-R or 970096 MP Base 1x2-R GDT or 970093 MP Base 1x2-R GND
97 00 33	MP 1x2 GDT+12V-Ad-Pg ST	
97 00 34	MP 1x2 GDT+24V-Ad-Pg ST	
97 00 35	MP 1x2 GDT+36V-Ad-Pg ST	
97 00 36	MP 1x2 GDT+48V-Ad-Pg ST	
97 00 37	MP 1x2 GDT+60V-Ad-Pg ST	
97 00 38	MP 1x2 GDT+170V-Ad-Pg ST	

Art.-No.	Product name module	Plug-in socket
97 00 39	MP 2x2 GDT+5V-Ad-Ad-Pg ST	970000 MP Base 2x2-R or 970001 MP Base 2x2-R GDT or 970091 MP Base 2x2-R GND
97 00 40	MP 2x2 GDT+12V-Ad-Ad-Pg ST	
97 00 41	MP 2x2 GDT+24V-Ad-Ad-Pg ST	
97 00 42	MP 2x2 GDT+36V-Ad-Ad-Pg ST	
97 00 43	MP 2x2 GDT+48V-Ad-Ad-Pg ST	
97 00 44	MP 2x2 GDT+60V-Ad-Ad-Pg ST	
97 00 45	MP 2x2 GDT+170V-Ad-Ad-Pg ST	
97 00 46	MP 1x2 GDT+5V-Ad-Ad-Pg ST	970095 MP Base 1x2-R or 970096 MP Base 1x2-R GDT or 970093 MP Base 1x2-R GND
97 00 47	MP 1x2 GDT+12V-Ad-Ad-Pg ST	
97 00 48	MP 1x2 GDT+24V-Ad-Ad-Pg ST	
97 00 49	MP 1x2 GDT+36V-Ad-Ad-Pg ST	
97 00 50	MP 1x2 GDT+48V-Ad-Ad-Pg ST	
97 00 51	MP 1x2 GDT+60V-Ad-Ad-Pg ST	
97 00 52	MP 1x2 GDT+170V-Ad-Ad-Pg ST	
97 00 57	MP 1x2 GDT+12V-Ad-Ad-FM	97 00 06 MP Base 1x2-R-FM
97 00 58	MP 1x2 GDT+24V-Ad-Ad-FM	
97 00 59	MP 1x2 GDT+36V-Ad-Ad-FM	
97 10 50	MP 2x2 5V-HF ST	970099 MP Base 2x2-R HF or 970100 MP Base 2x2-R GDT HF or 970101 MP Base 2x2-R GND HF
97 10 51	MP 2x2 24V-HF ST	
97 10 52	MP 1x2 5V-HF ST	970102 MP Base 1x2-R HF or 970103 MP Base 1x2-R GDT HF or 970104 MP Base 1x2-R GND HF
97 10 53	MP 1x2 24V-HF ST	
97 10 54	MP 2x2 5V-170-HF ST	970099 MP Base 2x2-R HF or 970100 MP Base 2x2-R GDT HF or 970101 MP Base 2x2-R GND HF
97 10 55	MP 2x2 24V-170-HF ST	
97 10 56	MP 1x2 5V-170-HF ST	970102 MP Base 1x2-R HF or 970103 MP Base 1x2-R GDT HF or 970104 MP Base 1x2-R GND HF
97 10 57	MP 1x2 24V-170-HF ST	

Order:

1. Choose the module + 2. suitable plug-in socket = MP unit





### RS485

#### DataPro RS485-Tr

- Mounting on 35 mm DIN rail (EN 60715)
- SPD for interface RS485
- Inflammability class according to UL 94 V0
- Degree of protection according to IEC EN 60529: IP 20
- EAC certification

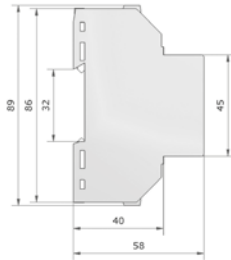
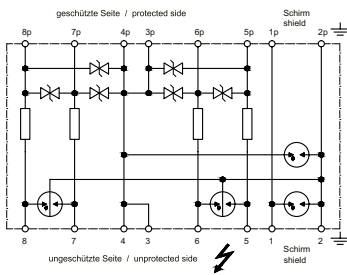

Technical Data	
<b>Product name</b>	<b>DP RS485-Tr</b>
Article-No.	27 04 85
Nominal voltage DC	UN 5 V=
Max. continuous operating voltage DC	Uc 6 V=
Nominal current	IL 0,5 A
Leakage current at Umax DC	≤ 5 μA
Max. frequency (-3 dB)	fG 1 MHz
Capacitance, line-earth	C ≤ 3 nF
DC resistance	R 1,8 Ω
Series inductance, typ.	L 10 μH
Protection level (line-line)	Up ≤ 8,5 V
Protection level (line-earth)	Up ≤ 600 V
Response time	tA ≤ 1 ns
Nominal discharge current (8/20 μs)	In 10 kA (line/line-PE)
Max. impulse discharge current (8/20 μs)	Imax 25 kA (line/line-PE)
Operating temperature range	TU -25 - +85 °C
Max. conductor cross section	2.5mm <sup>2</sup> solid or 1.5mm <sup>2</sup> flexible with sleeve
Max. connection torque for terminals	1,5 Nm
Enclosure material / colour	Polycarbonate UL 94-V0 / yellow





### One-piece SPD for MCR applications for high frequency

#### DataPro-SDSL-Tr

Surge voltage arrester with a two-step circuit to protect two single wires in data and signal lines. The arrester is especially designed for 24 Volt SPS input lines. It is suited for high-frequency and very fast data transmission. The arrester is applicable at the LPZ transition point OB - 2 and higher. Alternatively, direct and indirect earthing is possible.



Image example

- High performance surge protector
  - Lightning impulse current 5 kA (10/350 μs)
  - Transfer rate 100 Mbit/s
  - Nominal current 500 mA
  - fG > 300 MHz
  - For fast dataline signals
- High-resistance shield grounding via shield terminal possible.
  - Inflammability class according to UL 94 V0
  - Degree of protection according to IEC EN 60529: IP 20
  - Mounting on 35 mm DIN rail (EN 60715)
  - EAC certification

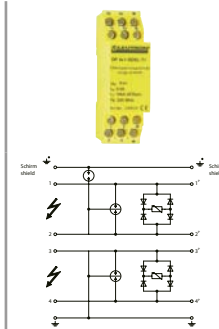
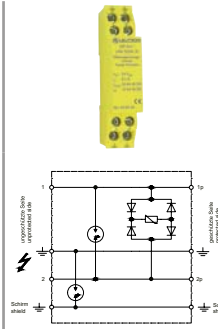
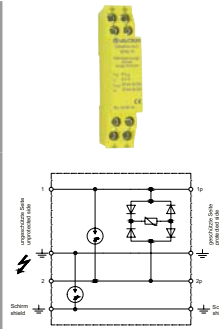
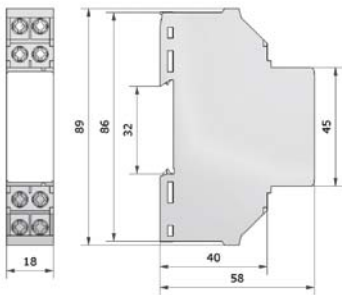

**Technical Data**

Product name	DataPro 2x1-SDSL-Tr	DP 2x1-24V-SDSL-Tr	DataPro 4x1-SDSL-Tr
Article-No.	24 00 18	24 00 24	24 00 20
Nominal voltage DC	UN 6 V=	24 V=	6 V=
Nominal current	IL 0,5 A	0,5 A	0,5 A
C2 nominal discharge current (8/20 μs) total	I <sub>max</sub> 20 kA	20 kA	20 kA
C2 nominal discharge current (8/20 μs) per line	I <sub>n</sub> 10 kA	10 kA	10 kA
Protection level 1p-2p;1p,2p-PE (1kV/μs)	U <sub>p</sub> ≤ 0,6 kV	≤ 0,6 kV	≤ 0,6 kV
Signal transmission rate	100 Mbit/s	100 Mbit/s	100 Mbit/s
Max. frequency (-3 dB)	f <sub>G</sub> 300 MHz	300 MHz	300 MHz
Operating temperature range	TU - 25 - + 85 °C	- 25 - + 85 °C	- 25 - + 85 °C
Series resistance	0 Ω	0 Ω	0 Ω
Series inductance, typ.	L 0 μH	0 μH	0 μH
Response time	t <sub>A</sub> ≤ 1 ns	≤ 1 ns	≤ 1 ns
Degree of protection (IEC EN 60529)	IP 20	IP 20	IP 20
Max. conductor cross section	2.5mm <sup>2</sup> solid or 1.5mm <sup>2</sup> flexible with sleeve		2.5mm <sup>2</sup> solid or 1.5mm <sup>2</sup> flexible with sleeve
Max. connection torque for terminals	1,5 Nm	1,5 Nm	1,5 Nm
Housing size WxHxD	17,5 x 87(90) x 58 mm	17,5 x 87(90) x 58 mm	17,5 x 87(90) x 58 mm
Terminals	Screw-type terminal	Screw-type terminal	Screw-type terminal

**Asseccories DataPro and EnerPro**

	Grounding bridge
Article-No.	17 00 80

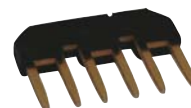

For an optimal bridging of the grounding terminals.



### One-piece SPD with high discharge capability for MCR applications

#### IsoProData-Tr

One-piece lightning current discharge arrester for signal lines with a discharge capability for use the at the building entry.

- Protective circuit for 2 signal lines without reference to ground potential
- Applicable at the boundaries LPZ 0A - 1 and higher
- Test standard: IEC 61643-21 / EN 61643-21
- Space required for installation: 17,5 mm
- Mounting on 35 mm DIN rail (EN 60715)
- Degree of protection according to IEC EN 60529: IP 20
- EAC certification

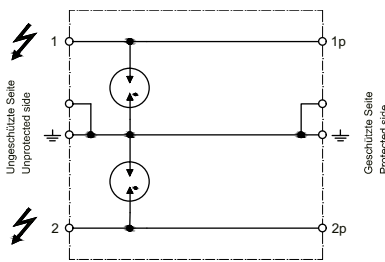

Technische Daten	
Product name	IsoProData-Tr
Article-No.	27 30 02
IEC category	D1 / C2 / C1 / C3
Nominal voltage DC	UN 150 V=
Max. continuous operating voltage DC	Uc 170 V=
Max. continuous operating voltage AC (50/60Hz)	Uc 120 V~
Nominal current	IL 1,5 A
Leakage current at Uc DC	≤ 0.001 μA
Response time	tA ≤ 50 ns
C2 Nominal discharge current (8/20 μs)	In 20 kA
D1 lightning impulse current (10/350 μs) total	Itotal 10 kA
D1 lightning impulse current (10/350 μs) per line	Iimp 5 kA
Protection level line-earth at 1 kV/μs	Up ≤ 800 V
Capacitance, line-earth	C < 0.005 nF
Insulation resistance	Risol > 10 GΩ
Operating temperature range	TU -25 - +85 °C
Max. conductor cross section	2.5mm <sup>2</sup> solid or 1.5mm <sup>2</sup> flexible with sleeve
Dimension B x H x T	17,5 x 87 x 58 mm
Enclosure material / colour	Polycarbonate UL 94-V0 / yellow

#### MP RK GDT

Terminal blocks with integrated surge protection can optimize the used space in a control cabinet and at the same time provide high level protection for terminal equipment and devices.

- Protective circuit for 2 signal lines without reference to ground potential
- Applicable at the boundaries LPZ 0B - 1 and higher
- Test standard: IEC 61643-21 / EN 61643-21
- Mounting on 35 mm DIN rail (EN 60715)
- 6.2 mm DIN rail module
- Earthing via DIN rail or connector
- EAC certification

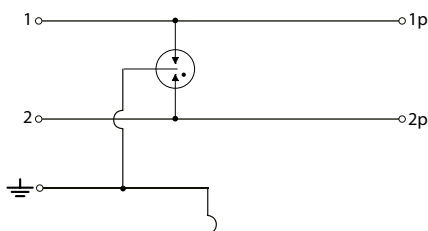

Technical Data	
Product name	MP RK GDT
Article-No.	97 10 03
IEC category	C2 / C1 / C3
Nominal voltage DC	UN 180 V=
Max. continuous operating voltage (DC/AC)	Uc 180/120 V
Nominal current	IL 2 A
C2 nominal discharge current (8/20 μs) total	I <sub>max</sub> 10 kA
C2 nominal discharge current (8/20 μs) per line	In 5 kA
Protection level line-line at In C2	Up ≤ 500 V
Protection level line-earth at In C2	Up ≤ 500 V
Protection level line-line at 1 kV/μs C3	Up ≤ 500 V
Protection level line-Pg at 1 kV/μs C3	Up ≤ 500 V
Series resistance per line	Rs 0 Ω
Max. frequency (-3 dB)	fG typ. 100 MHz
Conductor cross section (solid/stranded/AWG)	0.2-4.0/0.2-2.5 mm <sup>2</sup> / 24-12
Operating temperature range	TU -40 - +80 °C
Inflammability class according to UL 94	V0
Degree of protection (IEC EN 60529)	IP 20
Enclosure material / colour	PA6 / yellow



### One-piece SPD with high discharge capability and low protection level for MCR applications

#### MP RK GDT/Ad-Ad-Pg, MP RK GDT/Ad-Ad, MP RK GDT/Ad-Pg

Terminal blocks with integrated surge protection can optimize the used space in a control cabinet and at the same time provide high level protection for terminal equipment and devices.



Image example

- Protective circuit for 2 signal lines with common ground or without reference to ground potential
- Applicable at the boundaries LPZ 0B - 2 and higher
- Test standard: IEC 61643-21 / EN 61643-21
- Mounting on 35 mm DIN rail (EN 60715)
- 6.2 mm DIN rail module
- Earthing via DIN rail or connector
- Degree of protection according to IEC EN 60529: IP 20 (with cover)
- Inflammability class according to UL 94 V0
- EAC certification

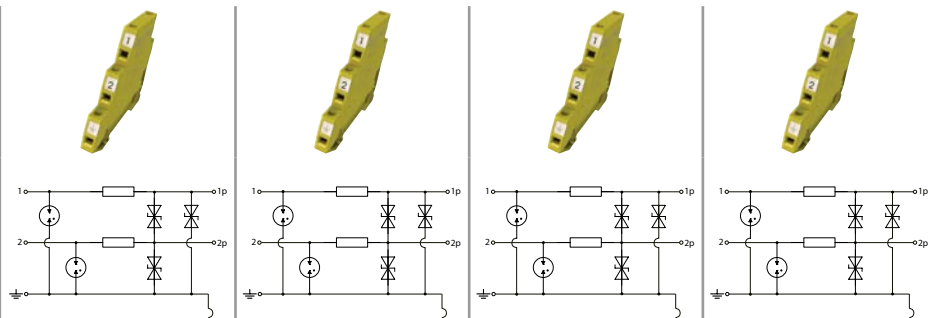
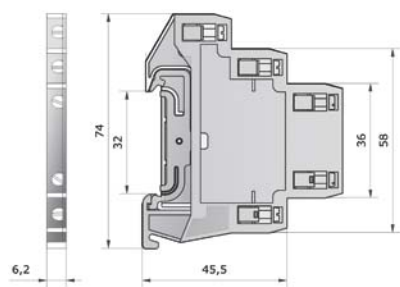

#### Technical Data

Product name	MP RK GDT+5V-Ad-Ad-Pg	MP RK GDT+12V-Ad-Ad-Pg	MP RK GDT+24V-Ad-Ad-Pg	MP RK GDT+36V-Ad-Ad-Pg
Article-No.	97 10 18	97 10 19	97 10 20	97 10 21
IEC category	C2 / C1 / C3	C2 / C1 / C3	C2 / C1 / C3	C2 / C1 / C3
Nominal voltage DC	UN 5 V=	12 V=	24 V=	36 V=
Max. continuous operating voltage (DC/AC)	Uc 6/4 V	15/11 V	33/23 V	45/32 V
Nominal current	IL 0,5 A	0,5 A	0,5 A	0,5 A
C2 nominal discharge current (8/20 μs) total	I <sub>max</sub> 10 kA	10 kA	10 kA	10 kA
C2 nominal discharge current (8/20 μs) per line	I <sub>n</sub> 5 kA	5 kA	5 kA	5 kA
Protection level line-line at I <sub>n</sub> C2	U <sub>p</sub> ≤ 13 V	≤ 25 V	≤ 59 V	≤ 75 V
Protection level line-earth at I <sub>n</sub> C2	U <sub>p</sub> ≤ 13 V	≤ 25 V	≤ 59 V	≤ 75 V
Protection level line-line at 1 kV/μs C3	U <sub>p</sub> ≤ 10 V	≤ 19 V	≤ 45 V	≤ 58 V
Protection level line-Pg at 1 kV/μs C3	U <sub>p</sub> ≤ 10 V	≤ 19 V	≤ 45 V	≤ 58 V
Series resistance per line	R <sub>s</sub> 2,2 Ω	2,2 Ω	2,2 Ω	2,2 Ω
Max. frequency (-3 dB)	f <sub>G</sub> typ. 1,0 MHz	typ. 3,0 MHz	typ. 6,0 MHz	typ. 8,0 MHz
Conductor cross section (solid/stranded/AWG)	0.2-4.0/0.2-2.5 mm <sup>2</sup> / 24-12	0.2-4.0/0.2-2.5 mm <sup>2</sup> / 24-12	0.2-4.0/0.2-2.5 mm <sup>2</sup> / 24-12	0.2-4.0/0.2-2.5 mm <sup>2</sup> / 24-12
Operating temperature range	TU -40 - +80 °C	-40 - +80 °C	-40 - +80 °C	-40 - +80 °C
Enclosure material / colour	PA6 / yellow	PA6 / yellow	PA6 / yellow	PA6 / yellow



### One-piece SPD with high discharge capability and low protection level for MCR applications

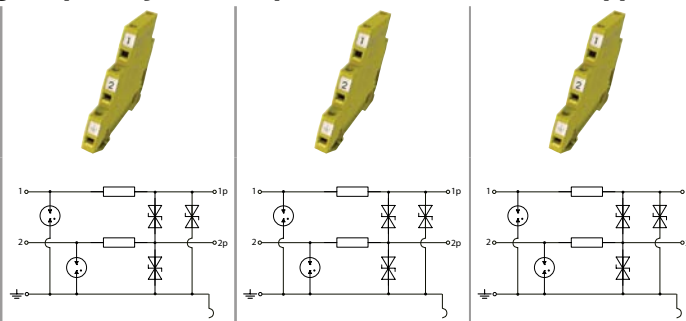

#### Technical Data

Product name	MP RK GDT+48V-Ad-Ad-Pg	MP RK GDT+60V-Ad-Ad-Pg	MP RK GDT+170V-Ad-Ad-Pg
Article-No.	97 10 22	97 10 23	97 10 24
IEC category	C2 / C1 / C3	C2 / C1 / C3	C2 / C1 / C3
Nominal voltage DC	UN 48 V=	60 V=	170 V=
Max. continuous operating voltage (DC/AC)	Uc 50/36 V	70/49 V	170/120 V
Nominal current	IL 0,5 A	0,5 A	0,5 A
C2 nominal discharge current (8/20 μs) total	Imax 10 kA	10 kA	10 kA
C2 nominal discharge current (8/20 μs) per line	In 5 kA	5 kA	5 kA
Protection level line-line at In C2	Up ≤ 90 V	≤ 120 V	≤ 320 V
Protection level line-earth at In C2	Up ≤ 90 V	≤ 120 V	≤ 320 V
Protection level line-line at 1 kV/μs C3	Up ≤ 70 V	≤ 90 V	≤ 250 V
Protection level line-Pg at 1 kV/μs C3	Up ≤ 70 V	≤ 90 V	≤ 250 V
Series resistance per line	Rs 2,2 Ω	2,2 Ω	2,2 Ω
Max. frequency (-3 dB)	fG typ. 10 MHz	typ. 12 MHz	typ. 25 MHz
Conductor cross section (solid/stranded/AWG)	0.2-4.0/0.2-2.5 mm <sup>2</sup> / 24-12	0.2-4.0/0.2-2.5 mm <sup>2</sup> / 24-12	0.2-4.0/0.2-2.5 mm <sup>2</sup> / 24-12
Operating temperature range	TU -40 - +80 °C	-40 - +80 °C	-40 - +80 °C
Enclosure material / colour	PA6 / yellow	PA6 / yellow	PA6 / yellow

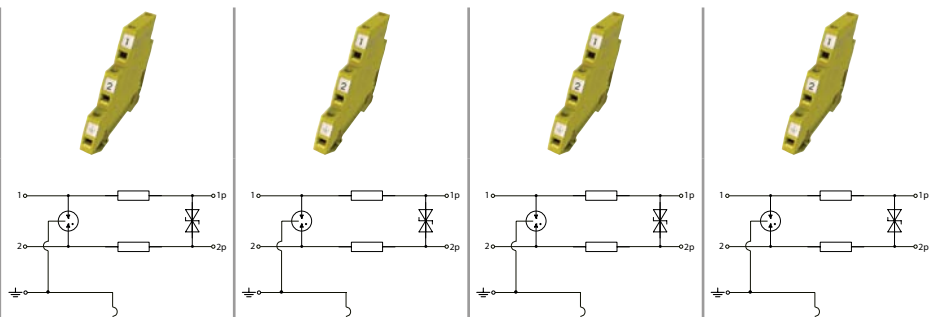

#### Technical Data

Product name	MP RK GDT+5V-Ad-Ad	MP RK GDT+12V-Ad-Ad	MP RK GDT+24V-Ad-Ad	MP RK GDT+36V-Ad-Ad
Article-No.	97 10 04	97 10 05	97 10 06	97 10 07
IEC category	C2 / C1 / C3	C2 / C1 / C3	C2 / C1 / C3	C2 / C1 / C3
Nominal voltage DC	UN 5 V=	12 V=	24 V=	36 V=
Max. continuous operating voltage (DC/AC)	Uc 6/4 V	15/11 V	33/23 V	45/32 V
Nominal current	IL 0,5 A	0,5 A	0,5 A	0,5 A
C2 nominal discharge current (8/20 μs) total	Imax 10 kA	10 kA	10 kA	10 kA
C2 nominal discharge current (8/20 μs) per line	In 5 kA	5 kA	5 kA	5 kA
Protection level line-line at In C2	Up ≤ 13 V	≤ 25 V	≤ 59 V	≤ 75 V
Protection level line-earth at In C2	Up ≤ 500 V	≤ 500 V	≤ 500 V	≤ 500 V
Protection level line-line at 1 kV/μs C3	Up ≤ 10 V	≤ 19 V	≤ 45 V	≤ 58 V
Protection level line-Pg at 1 kV/μs C3	Up ≤ 500 V	≤ 500 V	≤ 500 V	≤ 500 V
Series resistance per line	Rs 2,2 Ω	2,2 Ω	2,2 Ω	2,2 Ω
Max. frequency (-3 dB)	fG typ. 1,0 MHz	typ. 3,0 MHz	typ. 6,0 MHz	typ. 8,0 MHz
Conductor cross section (solid/stranded/AWG)	0.2-4.0/0.2-2.5 mm <sup>2</sup> / 24-12	0.2-4.0/0.2-2.5 mm <sup>2</sup> / 24-12	0.2-4.0/0.2-2.5 mm <sup>2</sup> / 24-12	0.2-4.0/0.2-2.5 mm <sup>2</sup> / 24-12
Operating temperature range	TU -40 - +80 °C	-40 - +80 °C	-40 - +80 °C	-40 - +80 °C
Enclosure material / colour	PA6 / yellow	PA6 / yellow	PA6 / yellow	PA6 / yellow

### One-piece SPD with high discharge capability and low protection level for MCR applications

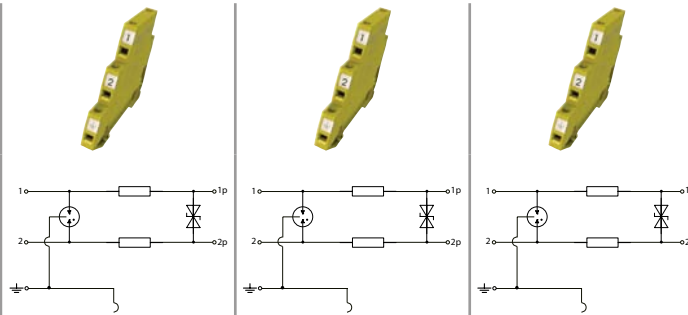

#### Technical Data

Product name	MP RK GDT+48V-Ad-Ad	MP RK GDT+60V-Ad-Ad	MP RK GDT+170V-Ad-Ad
Article-No.	97 10 08	97 10 09	97 10 10
IEC category	C2 / C1 / C3	C2 / C1 / C3	C2 / C1 / C3
Nominal voltage DC	UN 48 V=	60 V=	170 V=
Max. continuous operating voltage (DC/AC)	Uc 50/36 V	70/49 V	170/120 V
Nominal current	IL 0,5 A	0,5 A	0,5 A
C2 nominal discharge current (8/20 μs) total	Imax 10 kA	10 kA	10 kA
C2 nominal discharge current (8/20 μs) per line	In 5 kA	5 kA	5 kA
Protection level line-line at In C2	Up ≤ 90 V	≤ 120 V	≤ 320 V
Protection level line-earth at In C2	Up ≤ 500 V	≤ 500 V	≤ 500 V
Protection level line-line at 1 kV/μs C3	Up ≤ 70 V	≤ 90 V	≤ 250 V
Protection level line-Pg at 1 kV/μs C3	Up ≤ 500 V	≤ 500 V	≤ 500 V
Series resistance per line	Rs 2,2 Ω	2,2 Ω	2,2 Ω
Max. frequency (-3 dB)	fG typ. 10 MHz	typ. 12 MHz	typ. 25 MHz
Conductor cross section (solid/stranded/AWG)	0.2-4.0/0.2-2.5 mm <sup>2</sup> / 24-12	0.2-4.0/0.2-2.5 mm <sup>2</sup> / 24-12	0.2-4.0/0.2-2.5 mm <sup>2</sup> / 24-12
Operating temperature range	TU -40 - +80 °C	-40 - +80 °C	-40 - +80 °C
Enclosure material / colour	PA6 / yellow	PA6 / yellow	PA6 / yellow

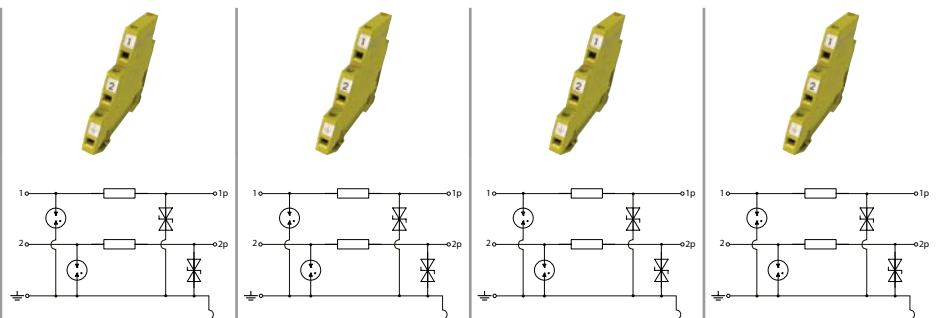

#### Technical Data

Product name	MP RK GDT+5V-Ad-Pg	MP RK GDT+12V-Ad-Pg	MP RK GDT+24V-Ad-Pg	MP RK GDT+36V-Ad-Pg
Article-No.	97 10 11	97 10 12	97 10 13	97 10 14
IEC category	C2 / C1 / C3	C2 / C1 / C3	C2 / C1 / C3	C2 / C1 / C3
Nominal voltage DC	UN 5 V=	12 V=	24 V=	36 V=
Max. continuous operating voltage (DC/AC)	Uc 6/4 V	15/11 V	33/23 V	45/32 V
Nominal current	IL 0,5 A	0,5 A	0,5 A	0,5 A
C2 nominal discharge current (8/20 μs) total	Imax 10 kA	10 kA	10 kA	10 kA
C2 nominal discharge current (8/20 μs) per line	In 5 kA	5 kA	5 kA	5 kA
Protection level line-line at In C2	Up ≤ 26 V	≤ 50 V	≤ 118 V	≤ 150 V
Protection level line-earth at In C2	Up ≤ 13 V	≤ 25 V	≤ 59 V	≤ 75 V
Protection level line-line at 1 kV/μs C3	Up ≤ 20 V	≤ 38 V	≤ 90 V	≤ 116 V
Protection level line-Pg at 1 kV/μs C3	Up ≤ 10 V	≤ 19 V	≤ 45 V	≤ 58 V
Series resistance per line	Rs 2,2 Ω	2,2 Ω	2,2 Ω	2,2 Ω
Max. frequency (-3 dB)	fG typ. 1,0 MHz	typ. 3,0 MHz	typ. 6,0 MHz	typ. 8,0 MHz
Conductor cross section (solid/stranded/AWG)	0.2-4.0/0.2-2.5 mm <sup>2</sup> / 24-12	0.2-4.0/0.2-2.5 mm <sup>2</sup> / 24-12	0.2-4.0/0.2-2.5 mm <sup>2</sup> / 24-12	0.2-4.0/0.2-2.5 mm <sup>2</sup> / 24-12
Operating temperature range	TU -40 - +80 °C	-40 - +80 °C	-40 - +80 °C	-40 - +80 °C
Enclosure material / colour	PA6 / yellow	PA6 / yellow	PA6 / yellow	PA6 / yellow



### One-piece SPD with high discharge capability and low protection level for MCR applications

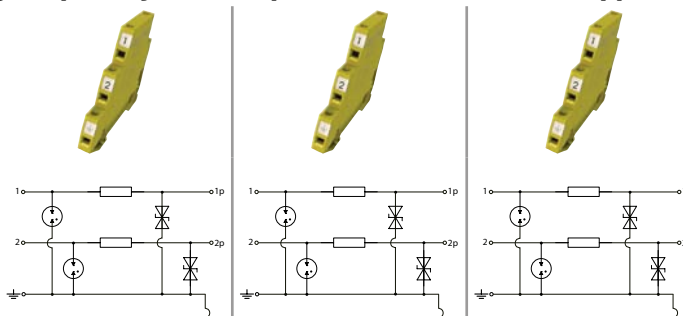

#### Technical Data

Product name	MP RK GDT+48V-Ad-Pg	MP RK GDT+60V-Ad-Pg	MP RK GDT+170V-Ad-Pg
Article-No.	97 10 15	97 10 16	97 10 17
IEC category	C2 / C1 / C3	C2 / C1 / C3	C2 / C1 / C3
Nominal voltage DC	UN 48 V=	60 V=	170 V=
Max. continuous operating voltage (DC/AC)	Uc 50/36 V	70/49 V	170/120 V
Nominal current	IL 0,5 A	0,5 A	0,5 A
C2 nominal discharge current (8/20 μs) total	Imax 10 kA	10 kA	10 kA
C2 nominal discharge current (8/20 μs) per line	In 5 kA	5 kA	5 kA
Protection level line-line at In C2	Up ≤ 180 V	≤ 240 V	≤ 600 V
Protection level line-earth at In C2	Up ≤ 90 V	≤ 120 V	≤ 320 V
Protection level line-line at 1 kV/μs C3	Up ≤ 140 V	≤ 180 V	≤ 500 V
Protection level line-Pg at 1 kV/μs C3	Up ≤ 70 V	≤ 90 V	≤ 250 V
Series resistance per line	Rs 2,2 Ω	2,2 Ω	2,2 Ω
Max. frequency (-3 dB)	fG typ. 10 MHz	typ. 12 MHz	typ. 25 MHz
Conductor cross section (solid/stranded/AWG)	0.2-4.0/0.2-2.5 mm <sup>2</sup> / 24-12	0.2-4.0/0.2-2.5 mm <sup>2</sup> / 24-12	0.2-4.0/0.2-2.5 mm <sup>2</sup> / 24-12
Operating temperature range	TU -40 - +80 °C	-40 - +80 °C	-40 - +80 °C
Enclosure material / colour	PA6 / yellow	PA6 / yellow	PA6 / yellow

#### Accessories

Article-No.	MP RK-AB 97 10 02
-------------	----------------------



Cover block terminal of MP series



### One-piece SPD with low protection level for MCR applications

#### MP RK/Ad-Ad, MP RK/Ad-Pg, MP RK/Ad-Ad-Pg

Terminal blocks with integrated surge protection can optimize the used space in a control cabinet and at the same time provide high level protection for terminal equipment and devices.



Image example

- Protective circuit for 2 signal lines with common ground or without reference to ground potential
- Applicable at the boundaries LPZ 1 - 2 and higher
- Test standard: IEC 61643-21 / EN 61643-21
- Mounting on 35 mm DIN rail (EN 60715)
- 6.2 mm DIN rail module
- Earthing via DIN rail or connector
- Degree of protection according to IEC EN 60529: IP 20 (with cover)
- Inflammability class according to UL 94 V0
- EAC certification

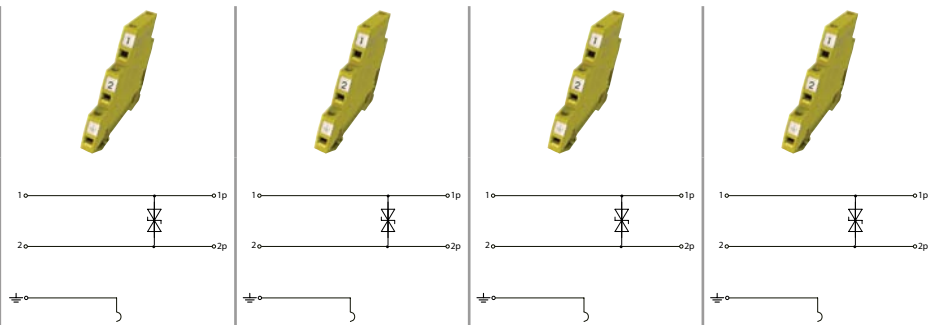
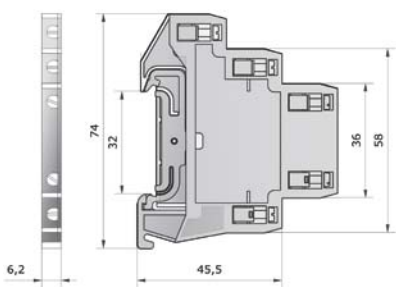

#### Technical Data

Product name	MP RK 5V-Ad-Ad	MP RK 12V-Ad-Ad	MP RK 24V-Ad-Ad	MP RK 36V-Ad-Ad
Article-No.	97 10 25	97 10 26	97 10 27	97 10 28
IEC category	C1 / C3	C1 / C3	C1 / C3	C1 / C3
Nominal voltage DC	UN 5 V=	12 V=	24 V=	36 V=
Max. continuous operating voltage (DC/AC)	Uc 6/4 V	15/11 V	33/23 V	45/32 V
Nominal current	IL 2,0 A	2,0 A	2,0 A	2,0 A
C1 Nominal discharge current (8/20 μs) total	In 0,8 kA	0,8 kA	0,6 kA	0,4 kA
C1 Nominal discharge current (8/20 μs) per line	In 0,4 kA	0,4 kA	0,3 kA	0,2 kA
Protection level line-line at In C1	Up ≤ 13 V	≤ 25 V	≤ 48 V	≤ 70 V
Protection level line-line at 1 kV/μs C3	Up ≤ 10 V	≤ 19 V	≤ 45 V	≤ 58 V
Series resistance per line	Rs 0 Ω	0 Ω	0 Ω	0 Ω
Max. frequency (-3 dB)	fG typ. 1,0 MHz	typ. 3,0 MHz	typ. 6,0 MHz	typ. 8,0 MHz
Conductor cross section (solid/stranded/AWG)	0.2-4.0/0.2-2.5 mm <sup>2</sup> / 24-12	0.2-4.0/0.2-2.5 mm <sup>2</sup> / 24-12	0.2-4.0/0.2-2.5 mm <sup>2</sup> / 24-12	0.2-4.0/0.2-2.5 mm <sup>2</sup> / 24-12
Operating temperature range	TU -40 - +80 °C	-40 - +80 °C	-40 - +80 °C	-40 - +80 °C
Enclosure material / colour	PA6 / yellow	PA6 / yellow	PA6 / yellow	PA6 / yellow



### One-piece SPD with low protection level for MCR applications

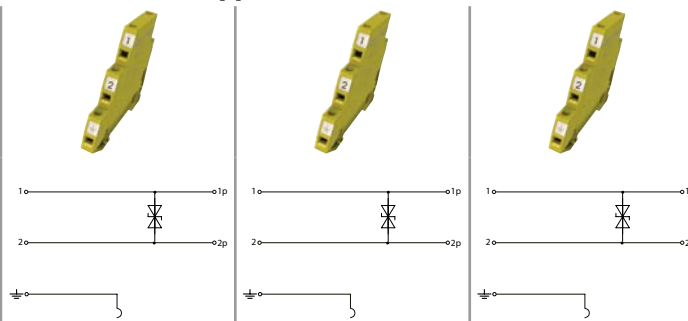

#### Technical Data

Product name	MP RK 48V-Ad-Ad	MP RK 60V-Ad-Ad	MP RK 170V-Ad-Ad
Article-No.	97 10 29	97 10 30	97 10 31
IEC category	C1 / C3	C1 / C3	C1 / C3
Nominal voltage DC	UN 48 V=	60 V=	170 V=
Max. continuous operating voltage (DC/AC)	Uc 50/36 V	70/49 V	170/120 V
Nominal current	IL 2,0 A	2,0 A	2,0 A
C1 Nominal discharge current (8/20 μs) total	In 0,3 kA	0,24 kA	0,2 kA
C1 Nominal discharge current (8/20 μs) per line	In 0,15 kA	0,12 kA	0,1 kA
Protection level line-line at In C1	Up ≤ 90 V	≤ 110 V	≤ 300 V
Protection level line-line at 1 kV/μs C3	Up ≤ 70 V	≤ 90 V	≤ 250 V
Series resistance per line	Rs 0 Ω	0 Ω	0 Ω
Max. frequency (-3 dB)	fG typ. 10 MHz	typ. 12 MHz	typ. 25 MHz
Conductor cross section (solid/stranded/AWG)	0.2-4.0/0.2-2.5 mm <sup>2</sup> / 24-12	0.2-4.0/0.2-2.5 mm <sup>2</sup> / 24-12	0.2-4.0/0.2-2.5 mm <sup>2</sup> / 24-12
Operating temperature range	TU -40 - +80 °C	-40 - +80 °C	-40 - +80 °C
Enclosure material / colour	PA6 / yellow	PA6 / yellow	PA6 / yellow

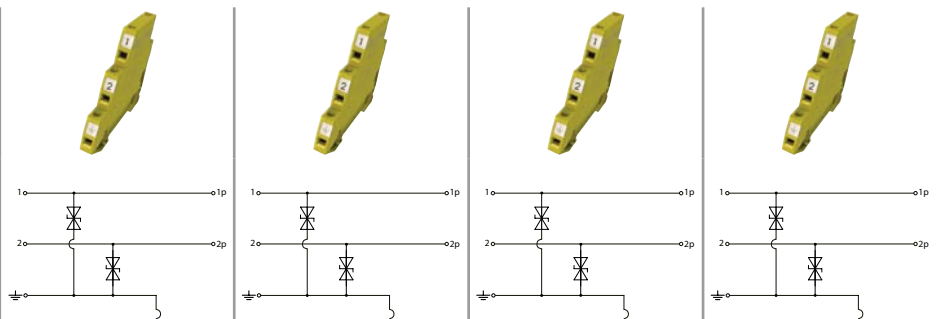







#### Technical Data

Product name	MP RK 5V-Ad-Pg	MP RK 12V-Ad-Pg	MP RK 24V-Ad-Pg	MP RK 36V-Ad-Pg
Article-No.	97 10 32	97 10 33	97 10 34	97 10 35
IEC category	C1 / C3	C1 / C3	C1 / C3	C1 / C3
Nominal voltage DC	UN 5 V=	12 V=	24 V=	36 V=
Max. continuous operating voltage (DC/AC)	Uc 6/4 V	15/11 V	33/23 V	45/32 V
Nominal current	IL 2,0 A	2,0 A	2,0 A	2,0 A
C1 Nominal discharge current (8/20 μs) total	In 0,8 kA	0,8 kA	0,6 kA	0,4 kA
C1 Nominal discharge current (8/20 μs) per line	In 0,4 kA	0,4 kA	0,3 kA	0,2 kA
Protection level line-line at In C1	Up ≤ 26 V	≤ 50 V	≤ 96 V	≤ 140 V
Protection level line-Pg at In C1	Up ≤ 13 V	≤ 25 V	≤ 48 V	≤ 70 V
Protection level line-line at 1 kV/μs C3	Up ≤ 20 V	≤ 38 V	≤ 90 V	≤ 116 V
Protection level line-Pg at 1 kV/μs C3	Up ≤ 10 V	≤ 19 V	≤ 45 V	≤ 58 V
Series resistance per line	Rs 0 Ω	0 Ω	0 Ω	0 Ω
Max. frequency (-3 dB)	fG typ. 1,0 MHz	typ. 3,0 MHz	typ. 6,0 MHz	typ. 8,0 MHz
Conductor cross section (solid/stranded/AWG)	0.2-4.0/0.2-2.5 mm <sup>2</sup> / 24-12	0.2-4.0/0.2-2.5 mm <sup>2</sup> / 24-12	0.2-4.0/0.2-2.5 mm <sup>2</sup> / 24-12	0.2-4.0/0.2-2.5 mm <sup>2</sup> / 24-12
Operating temperature range	TU -40 - +80 °C	-40 - +80 °C	-40 - +80 °C	-40 - +80 °C
Enclosure material / colour	PA6 / yellow	PA6 / yellow	PA6 / yellow	PA6 / yellow



### One-piece SPD with low protection level for MCR applications

			
<b>Technical Data</b>			
<b>Product name</b>	<b>MP RK 48V-Ad-Pg</b>	<b>MP RK 60V-Ad-Pg</b>	<b>MP RK 170V-Ad-Pg</b>
Article-No.	97 10 36	97 10 37	97 10 38
IEC category	C1 / C3	C1 / C3	C1 / C3
Nominal voltage DC	UN 48 V=	60 V=	170 V=
Max. continuous operating voltage (DC/AC)	Uc 50/36 V	70/49 V	170/120 V
Nominal current	IL 2,0 A	2,0 A	2,0 A
C1 Nominal discharge current (8/20 μs) total	In 0,3 kA	0,24 kA	0,2 kA
C1 Nominal discharge current (8/20 μs) per line	In 0,15 kA	0,12 kA	0,1 kA
Protection level line-line at In C1	Up ≤ 180 V	≤ 220 V	≤ 600 V
Protection level line-earth at In C1	Up ≤ 90 V	≤ 110 V	≤ 300 V
Protection level line-line at 1 kV/μs C3	Up ≤ 140 V	≤ 180 V	≤ 500 V
Protection level line-Pg at 1 kV/μs C3	Up ≤ 70 V	≤ 90 V	≤ 250 V
Series resistance per line	Rs 0 Ω	0 Ω	0 Ω
Max. frequency (-3 dB)	fG typ. 10 MHz	typ. 12 MHz	typ. 25 MHz
Conductor cross section (solid/stranded/AWG)	0.2-4.0/0.2-2.5 mm <sup>2</sup> / 24-12	0.2-4.0/0.2-2.5 mm <sup>2</sup> / 24-12	0.2-4.0/0.2-2.5 mm <sup>2</sup> / 24-12
Operating temperature range	TU -40 - +80 °C	-40 - +80 °C	-40 - +80 °C
Enclosure material / colour	PA6 / yellow	PA6 / yellow	PA6 / yellow

				
<b>Technical Data</b>				
<b>Product name</b>	<b>MP RK 5V-Ad-Ad-Pg</b>	<b>MP RK 12V-Ad-Ad-Pg</b>	<b>MP RK 24V-Ad-Ad-Pg</b>	<b>MP RK 36V-Ad-Ad-Pg</b>
Article-No.	97 10 39	97 10 40	97 10 41	97 10 42
IEC category	C1 / C3	C1 / C3	C1 / C3	C1 / C3
Nominal voltage DC	UN 5 V=	12 V=	24 V=	36 V=
Max. continuous operating voltage (DC/AC)	Uc 6/4 V	15/11 V	33/23 V	45/32 V
Nominal current	IL 2,0 A	2,0 A	2,0 A	2,0 A
C1 Nominal discharge current (8/20 μs) total	In 0,8 kA	0,8 kA	0,6 kA	0,4 kA
C1 Nominal discharge current (8/20 μs) per line	In 0,4 kA	0,4 kA	0,3 kA	0,2 kA
Protection level line-line at In C1	Up ≤ 13 V	≤ 25 V	≤ 48 V	≤ 70 V
Protection level line-earth at In C1	Up ≤ 13 V	≤ 25 V	≤ 48 V	≤ 70 V
Protection level line-line at 1 kV/μs C3	Up ≤ 10 V	≤ 19 V	≤ 45 V	≤ 58 V
Protection level line-Pg at 1 kV/μs C3	Up ≤ 10 V	≤ 19 V	≤ 45 V	≤ 58 V
Series resistance per line	Rs 0 Ω	0 Ω	0 Ω	0 Ω
Max. frequency (-3 dB)	fG typ. 1,0 MHz	typ. 3,0 MHz	typ. 6,0 MHz	typ. 8,0 MHz
Conductor cross section (solid/stranded/AWG)	0.2-4.0/0.2-2.5 mm <sup>2</sup> / 24-12	0.2-4.0/0.2-2.5 mm <sup>2</sup> / 24-12	0.2-4.0/0.2-2.5 mm <sup>2</sup> / 24-12	0.2-4.0/0.2-2.5 mm <sup>2</sup> / 24-12
Operating temperature range	TU -40 - +80 °C	-40 - +80 °C	-40 - +80 °C	-40 - +80 °C
Enclosure material / colour	PA6 / yellow	PA6 / yellow	PA6 / yellow	PA6 / yellow



### One-piece SPD with low protection level for MCR applications

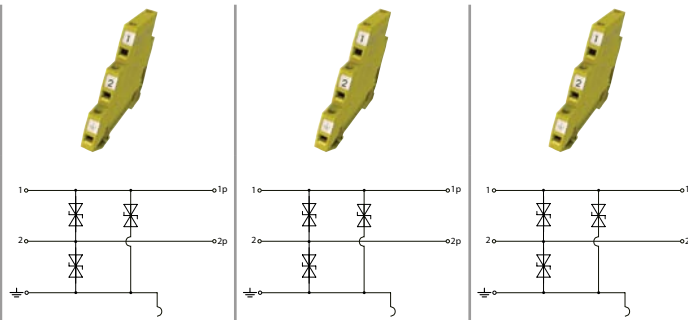

#### Technical Data

Product name	MP RK 48V-Ad-Ad-Pg	MP RK 60V-Ad-Ad-Pg	MP RK 170V-Ad-Ad-Pg
Article-No.	97 10 43	97 10 44	97 10 45
IEC category	C1 / C3	C1 / C3	C1 / C3
Nominal voltage DC	UN 48 V=	60 V=	170 V=
Max. continuous operating voltage (DC/AC)	Uc 50/36 V	70/49 V	170/120 V
Nominal current	IL 2,0 A	2,0 A	2,0 A
C1 Nominal discharge current (8/20 μs) total	In 0,3 kA	0,24 kA	0,2 kA
C1 Nominal discharge current (8/20 μs) per line	In 0,15 kA	0,12 kA	0,1 kA
Protection level line-line at In C1	Up ≤ 90 V	≤ 110 V	≤ 300 V
Protection level line-earth at In C1	Up ≤ 90 V	≤ 110 V	≤ 300 V
Protection level line-line at 1 kV/μs C3	Up ≤ 70 V	≤ 90 V	≤ 250 V
Protection level line-Pg at 1 kV/μs C3	Up ≤ 70 V	≤ 90 V	≤ 250 V
Series resistance per line	Rs 0 Ω	0 Ω	0 Ω
Max. frequency (-3 dB)	fG typ. 10 MHz	typ. 12 MHz	typ. 25 MHz
Conductor cross section (solid/stranded/AWG)	0.2-4.0/0.2-2.5 mm <sup>2</sup> / 24-12	0.2-4.0/0.2-2.5 mm <sup>2</sup> / 24-12	0.2-4.0/0.2-2.5 mm <sup>2</sup> / 24-12
Operating temperature range	TU -40 - +80 °C	-40 - +80 °C	-40 - +80 °C
Enclosure material / colour	PA6 / yellow	PA6 / yellow	PA6 / yellow

#### Accessories

Article-No.	MP RK-AB 97 10 02
-------------	----------------------

Cover block terminal of MP series





### MSR-M20

The protection device is a unique unit providing a level of protection for field-mounted transmitters that is far in excess of the optional transient protection facilities available from the transmitter manufacturers - without involving any additional wiring, conduit modifications or other expensive extras.

- Applicable at the LPZ transition point OB-2 and higher
- Easy mounting directly
- Highest protection level with inline installation
- Low impedance series connection avoids signal degradation of the loop
- Intrinsically safe and flameproof
- Test standard: IEC 61643-21 / EN 61643-21
- Earthing via metal housing
- EAC certification

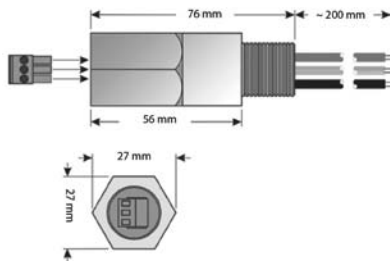
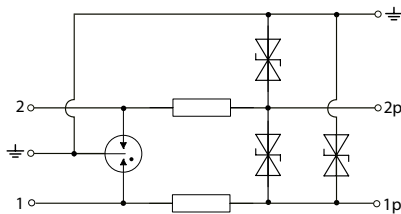

Technical Data	
<b>Product name</b>	<b>MSR-M20-24V</b>
Article-No.	97 20 11
IEC category	D1 / C2 / C1 / C3
Nominal voltage DC	UN 24 V=
Max. continuous operating voltage DC	Uc 32 V=
Nominal current	IL 1,5 A
D1 lightning impulse current (10/350 µs) per line	limp 1,0 kA
C2 nominal discharge current (8/20 µs) total	Imax 10 kA
Protection level line-line at In C2	Up - V
Protection level line-earth at In C2	Up - V
Series resistance per line	Rs 0,5 Ω
Capacitance line-line	C ≤ 400 pF
Capacitance line-earth	C ≤ 20 pF
Max. frequency Ad-Ad	fG 14 MHz
Operating temperature range	TU -40 - +80 °C
Terminal input/output	srew/line 1,5 mm <sup>2</sup>
Conductor cross section single wire	0,08-2,5 mm <sup>2</sup>
Conductor cross section fine stranded	0,08-1,5 mm <sup>2</sup>
Length of connecting line	200 mm



## COMPREHENSIVE PROTECTION OF ALL COMMUNICATION NETWORKS

For an unobstructed data transmission it is vital to protect the communication networks against surge voltages. Leutron's products reliably protect server rooms, workstations, IT and telephone installations against surge voltages – protection concepts for large-scale as well as for small installations are offered.

**Leutron offers an optimum protection for the communication networks of its clients.**

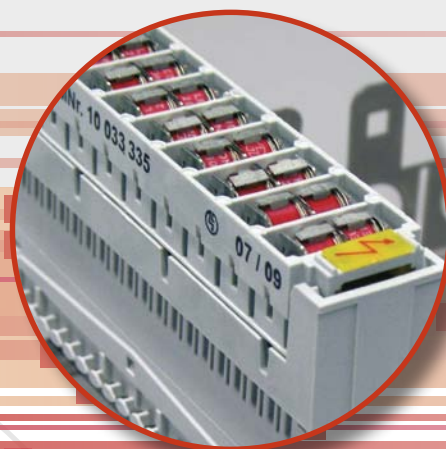
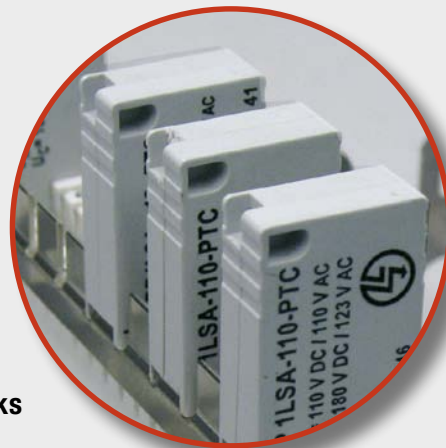

## ENHANCED AVAILABILITY IN COMPLEX COMMUNICATION ENVIRONMENTS:

- All-purpose protection devices for all communication networks due to different interfaces and various bandwidths (up to 10 G Ethernet)
- The overvoltage is limited to non-hazardous values with protection levels adapted to the protection-needing equipment
- Plug-and-play units for IT installations improve the operational availability





Well-proven protection of telecommunication installations – scalable in size and layout

## **SURGE PROTECTION** **FOR INFORMATION TECHNOLOGY AND** **TELECOMMUNICATION INSTALLATIONS**

## PROTECTION OF DATA NETWORKS, E.G. ETHERNET AND LAN

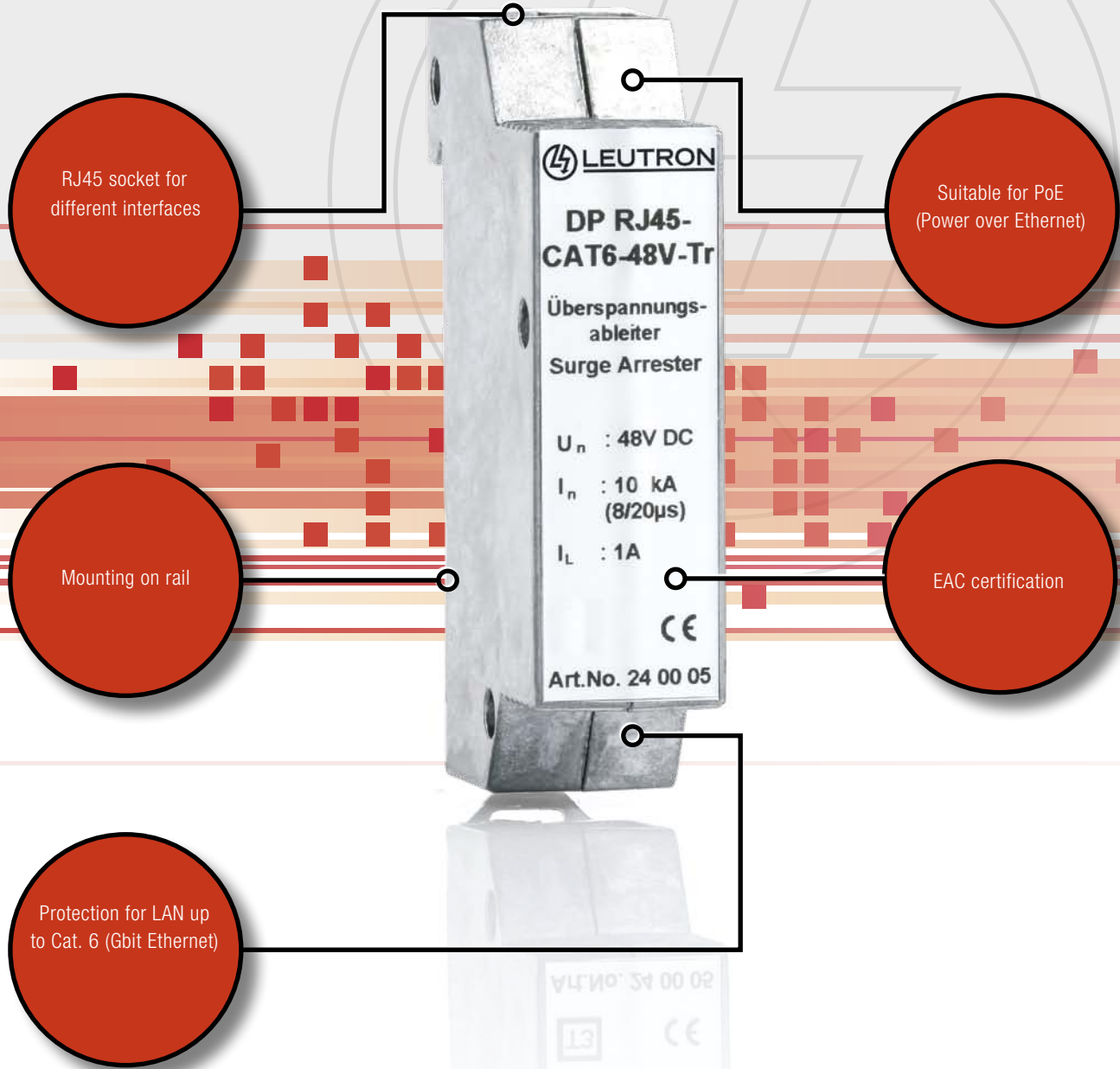

RJ45 socket for different interfaces

Suitable for PoE (Power over Ethernet)

Mounting on rail

EAC certification

Protection for LAN up to Cat. 6 (Gbit Ethernet)

LEUTRON

DP RJ45-CAT6-48V-Tr

Überspannungsableiter  
Surge Arrester

$U_n$  : 48V DC

$I_n$  : 10 kA  
(8/20µs)

$I_L$  : 1A

CE

Art.No. 24 00 05

Art.No. 24 00 05

13

CE

U<sub>n</sub> : 48V

(8/20µs)

I<sub>n</sub> : 10kA

I<sub>L</sub> : 1A



## SSCT (LSA) MOUNTING TECHNOLOGY

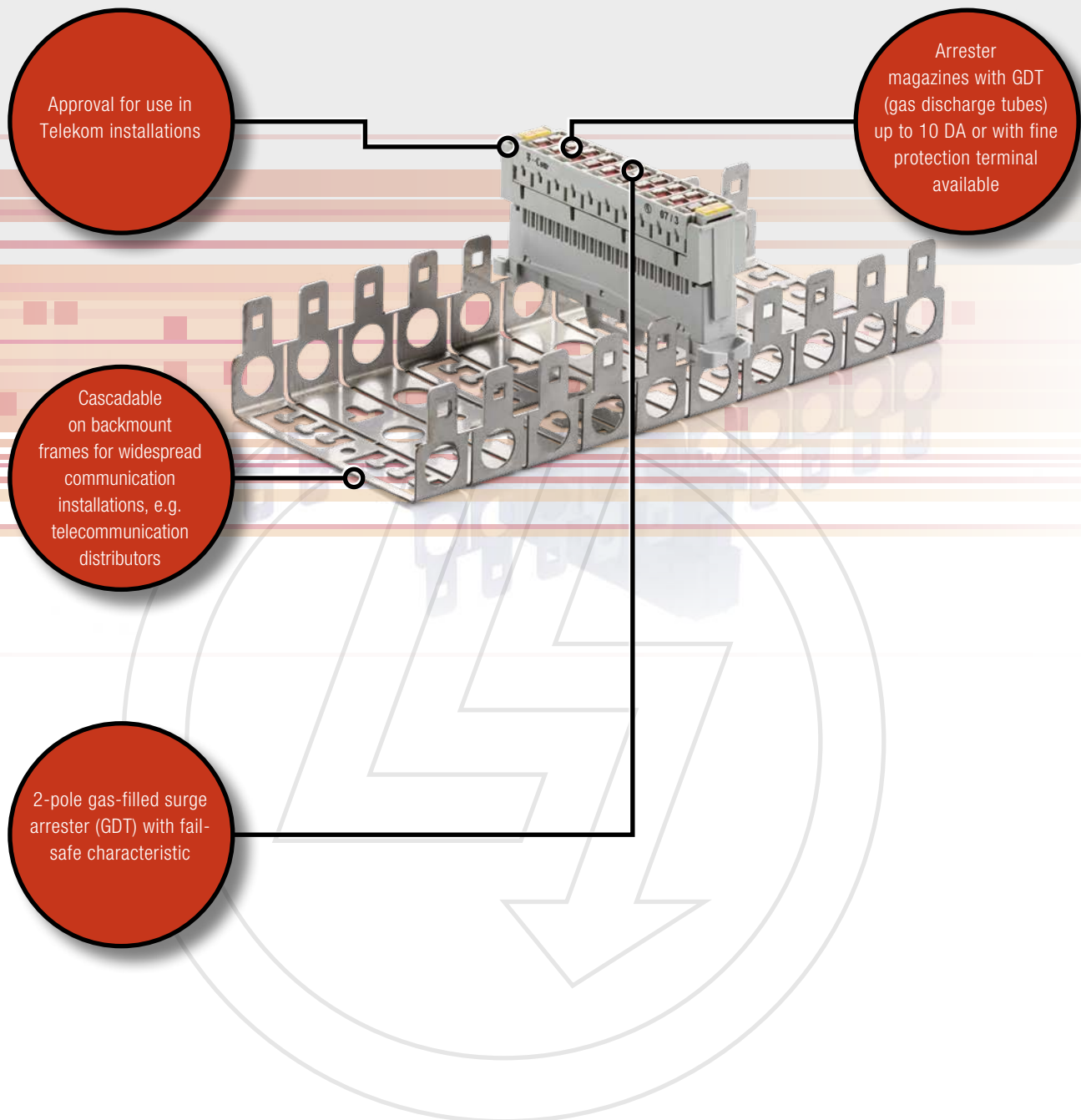



# SURGE PROTECTION FOR INFORMATION TECHNOLOGY AND TELECOMMUNICATION

## TABLE OF CONTENTS

SPD for communication networks		Page
<b>Cat. 6 / Class E application</b>		<b>143</b>
DataPro RJ45-CAT6	Suitable for Cat. 6, DIN rail mounting	143
<b>Cat. 5 / Class D application</b>		<b>143</b>
DataPro RJ45-48V-Tr	Suitable for Cat. 5, DIN rail mounting	143
DataPro RJ11/RJ12-Tr	Suitable for Cat. 5, DIN rail mounting	144
DataPro RJ45 (f/f)	Suitable for Cat. 5 / plug adapter	144
DataPro-1xRJ45-PoE-Alu	Suitable for Cat. 5 / plug adapter	145
DataPro 8xRJ45-6V-WG	Suitable for Cat. 5 / wall mounting	146
DataPro x8RJ45-19"	Suitable for Cat. 5 / racks in 19 inches housing	147
<b>SPD for telecommunication networks and D-sub Terminals</b>		<b>149</b>
DataPro-TAE/NFN-aP	Surface-mounted housing for analog lines	149
DataPro RS	Plug adapter for serial RS 232, RS 422 and RS 485 interfaces	149
<b>Surge protective devices for LSA mounting</b>		
<b>SPD according to test category D1+C2</b>		<b>151</b>
TelPro LSA 2/10-2E 8x6	LSA magazines, filled with 2 pole GDT	151
TelPro LSA 2/10-3E 8x13	LSA magazines, filled with 3 pole GDT	152
MTH/MTL series	HVT 71 magazine (main distributor Siemens 1971) 90 VDC / 230VDC	153
<b>SPD according to test category C2+C1</b>		<b>154</b>
DataPro 1LSA	Moduls for 1 DA in LSA disconnection module with different voltages	154
DataPro 1LSA + PTC	Moduls (+PTC) for 1 DA in LSA discon. Module with different voltages	156
DataPro 1LSA-T110FS-PTC	Modul (+PTC) for 1 DA in LSA disconnection module	157
DataPro 1LSA-CxxFS-PTC	Moduls for 1 DA in LSA discon. module with different voltages (+FS)	158
DataPro 1LSA-TK180FS	Moduls for 1 DA in LSA disconnection module with fail safe (FS)	159
DataPro 10LSA-PTC	Moduls (+PTC) for 10 DA in LSA disconnection module	160
<b>Accessories for LSA Technology</b>		<b>161</b>
LSA disconnection module / LSA ground module / LSA Connection Module / LSA parts		161







### Cat. 6 / Class E application

#### DataPro RJ45-CAT6-48V-Tr

Compact surge protective module for the protection of data networks, and network devices such as hubs, switches, server. The adaptor plug style provides an easy application in cable ducts or directly at the terminal equipment.

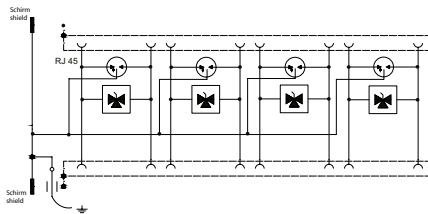
- Suitable for Cat. 6 / class E applications (up to Gbit Ethernet)
- Applicable at the boundaries LPZ 0B - 2 and higher
- Test standards: IEC 61643-21 / EN 61643-21
- All 8 signal lines (4 pair of wires) are protected simultaneously
- RJ45 SPD for PoE (Power over Ethernet)
- Mounting on 35 mm DIN rail (EN 60715)
- EAC certification



<b>Technical Data</b>		
<b>Product name</b>	<b>DP RJ45-CAT6-48V-Tr</b>	
Article-No.	24 00 05	
IEC category	D1 / C2 / C1 / C3	
Nominal voltage DC	UN	48 V=
Max. continuous operating voltage DC	Uc	48 V=
Operating current	IL	1 A
D1 lightning impulse current (10/350 µs)	limp	1kA
C2 nominal discharge current (8/20 µs) line-line	In	0,15 kA
C2 nominal discharge current (8/20 µs) total	Imax	10 kA
Protection level at In (line-line)	Up	150 V
Protection level at In (line-earth)	Up	550 V
Max. frequency	fG	250 MHz
Response time	tA	1 ns
Terminal input/output	RJ 45, shielded	
Dimensions (L x W x H)	19 x 75 x 46 mm	
Degree of protection (IEC EN 60529)	IP 20	
Housing material	Metall	

### Cat. 5 /Class D application

#### DataPro RJ45-48V-Tr

Compact surge protective module for the protection of data networks, and network devices such as hubs, switches, server. The adaptor plug style provides an easy application in cable ducts or directly at the terminal equipment.

- Suitable for Cat. 5
- Compatible to 10Base T / 100Base T
- Applicable at the boundaries LPZ 1 - 2 and higher
- Test standards: IEC 61643-21 / EN 61643-21
- Mounting on 35 mm DIN rail (EN 60715)
- RJ45 SPD for PoE (Power over Ethernet)
- All 8 signal lines (4 pair of wires) are protected simultaneously.
- EAC certification

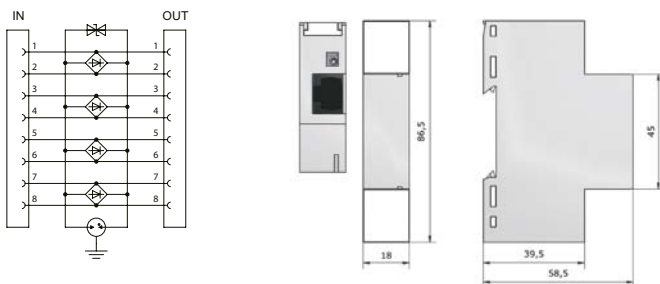

<b>Technical Data</b>		
<b>Product name</b>	<b>DP RJ45-48V-Tr</b>	
Article-No.	23 90 00	
IEC category	C2 / C1 / C3	
Nominal voltage DC	UN	48 V=
Max. continuous operating voltage DC	Uc	57 V=
C2 nominal discharge current (8/20 µs)	In	5 kA
Protection level at 1kV/µs	Up	≤ 500 V
Protection level at In (8/20 µs)	Up	≤ 600 kV
Max. frequency	fG	≤ 100 MHz
Operating temperature range	TU	-40 - +80 °C
Terminal input/output	RJ 45, shielded	
Degree of protection (IEC EN 60529)	IP 20	
Dimension (DIN 43880)	TE	1 TE
Housing material	Polycarbonat UL94-V0/yellow	



### Cat. 5 /Class D application

#### DataPro RJ11/RJ12-Tr

Compact surge protective module for the protection of data networks, and network devices such as hubs, switches, server. The adaptor plug style provides an easy application in cable ducts or directly at the terminal equipment.

- Suitable for Cat. 5
- Compatible to 10Base T / 100Base T
- Applicable at the boundaries LPZ 1 - 2 and higher
- Test standards: IEC 61643-21 / EN 61643-21
- RJ11/RJ12 SPD for DIN rail mounting
- RJ11/RJ12 SPD for PoE (Power over Ethernet)
- All 6 signal lines (3 pair of wires) are protected simultaneously
- EAC certification

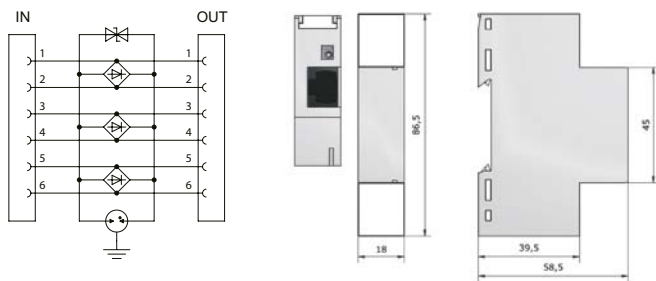

Technical Data	
<b>Product name</b>	<b>DP RJ11/RJ12-48V-Tr</b>
Article-No.	23 90 06
IEC category	C2 / C1 / C3
Nominal voltage DC	UN 48 V=
Max. continuous operating voltage DC	Uc 57 V=
C2 nominal discharge current (8/20 μs)	In 5 kA
Protection level at 1kV/μs	Up ≤ 500 V
Protection level at In (8/20 μs)	Up ≤ 600 kV
Max. frequency	fG ≤ 100 MHz
Operating temperature range	TU -40 - +80 °C
Terminal input/output	RJ11/RJ12, shielded
Degree of protection (IEC EN 60529)	IP 20
Dimension (DIN 43880)	TE 1 TE
Housing material	Polycarbonat UL94-V0/gelb

#### DataPro RJ45 (f/f)

Compact surge protective module for the protection of data networks, and network devices such as hubs, switches, server. The adaptor plug style provides an easy application in cable ducts or directly at the terminal equipment.

- Suitable for Cat. 5 / Class D
- Applicable at the boundaries LPZ 0B - 2 and higher.
- Test standards: IEC 61643-21 / EN 61643-21
- Compatible to 10Base T / 100Base T
- All 8 signal lines (4 pair of wires) are protected simultaneously.
- EAC certification

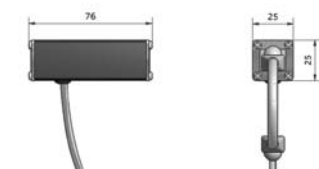
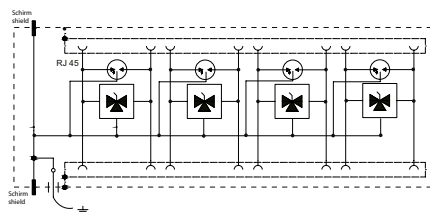

Technical Data	
<b>Product name</b>	<b>DP RJ45 f/f</b>
Article-No.	24 00 11
IEC category	C2 / C1 / C3
Nominal voltage DC	UN 6 V=
Max. continuous operating voltage DC	Uc 8 V=
C2 nominal discharge current (8/20 μs)	In 2,5 kA
Protection level at In (8/20 μs)	Up 35 kV
Max. frequency	fG 100 MHz
Operating temperature range	TU -40 - +80 °C
Terminal input/output	RJ 45, shielded
Degree of protection (IEC EN 60529)	IP 20
Housing material	Metall



### Cat. 5 /Class D application

#### DataPro-1xRJ45-PoE-Alu

Compact surge protective module for the protection of data networks, and network devices such as hubs, switches, server. The adaptor plug style provides an easy application in cable ducts or directly at the terminal equipment.

- Suitable for Cat. 5 / Class D
- Applicable at the boundaries LPZ 0B - 2 and higher.
- Test standards: IEC 61643-21 / EN 61643-21
- Compatible to 10Base T / 100Base T
- RJ45 SPD for PoE (Power over Ethernet)
- All 8 signal lines (4 pair of wires) are protected simultaneously.

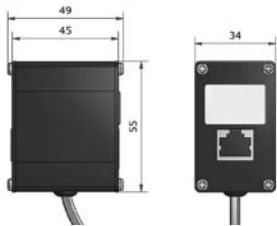
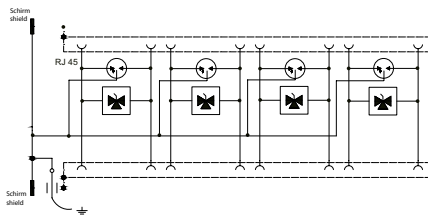

Technical Data	
<b>Product name</b>	<b>DP 1xRJ45-PoE-Alu</b>
Article-No.	24 00 21
IEC category	C2 / C1 / C3
Nominal voltage DC	UN 48 V=
Max. continuous operating voltage DC	Uc 60 V=
Operating current	IL 650 mA
Nom. discharge current (8/20 μs) line-line	In 0,5 kA
Nom. discharge current (8/20 μs) line-earth	In 2,0 kA
Schutzpegel Ad-Ad at 1 kV/μs C3	Up ≤ 180 V
Schutzpegel Ad-Pg at 1 kV/μs C3	Up ≤ 600 V
Max. frequency	fG ≤ 100 MHz
Terminal input/output	RJ 45, shielded
Degree of protection (IEC EN 60529)	IP 20
Housing material	Metall





### Cat. 5 /Class D application

### DataPro 8xRJ45-6V-WG

Compact surge protective module in a wall housing for the protection of data networks and network devices such as hubs, switches, server and desktop computer.



example image

- Applicable at the boundaries LPZ 1 - 2 and higher
- RJ45 wall housing for 8 ports
- Suitable for Cat. 5 / Class D
- Compatible to 10Base T / 100Base T
- Test standards: IEC 61643-21 / EN 61643-21
- All 8 signal lines (4 pair of wires) are protected simultaneously.
- 6 Ports à 6 V DC/ 2 Ports à 48 V DC
- EAC certification

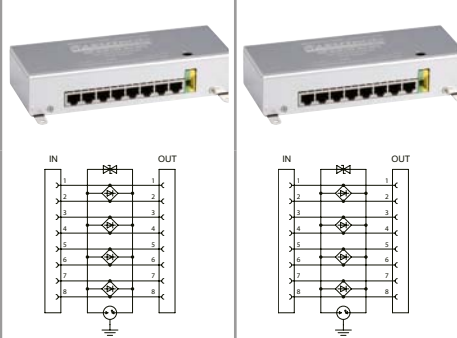
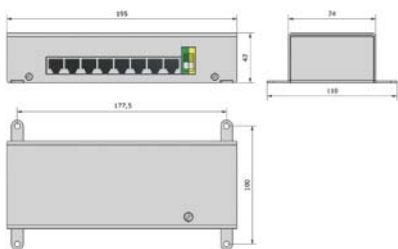

#### Technical Data

Product name	DP 8xRJ45-6V-WG	DP 8xRJ45-6x6V/2x48V-WG
Article-No.	19 40 50	19 40 51
IEC category	C2 / C1 / C3	C2 / C1 / C3
Nominal voltage DC	UN 6 V=	6 x 6 / 2 x 48 V=
Max. continuous operating voltage DC	Uc 8,1 V=	8,1 V=
Nominal current per line	IL 100 mA	100 mA
C1 nominal discharge current (8/20 μs) per line	In 200 A	200 A
C2 Total discharge current (8/20 μs) line-earth (PE)	Imax 2,5 kA	2,5 kA
C1 protection level line-line at In	Up ≤ 45 V	≤ 76 V
C1 protection level line-earth at In	Up ≤ 350 V	≤ 243 V
C3 protection level line-line at 1kV/μs	Up ≤ 40 V	≤ 146 V
C3 protection level line-earth at 1kV/μs	Up ≤ 350 V	≤ 243 V
Response time line-line/ line-shield	tA ≤ 1 ns	≤ 1 ns
Response time line-earth/ earth-shield	tA < 100 ns	< 100 ns
Max. frequency	fG 100 MHz	100 MHz
Operating temperature range	TU -40 - +80 °C	-40 - +80 °C
Terminal input/output	8 x RJ 45, shielded	8 x RJ 45, shielded
Housing material	Aluminium	Aluminium
Degree of protection (IEC EN 60529)	IP 20	IP 20



### Cat. 5 /Class D application

### DataPro x8RJ45-19"

Compact surge protective module in 19" housing with only 1 HE (45 mm) for the protection of data networks and network devices such as hubs, switches, server and desktop computer. Easy installation and wiring in all 19" distribution and server racks possible.



example image

- Applicable at the boundaries LPZ 1 - 2 and higher
- Fully shielded 19" housing can be equipped with up to 24 RJ45 protection ports
- Suitable for Cat. 5 / Class D
- Compatible to 10Base T / 100Base T
- Test standards: IEC 61643-21 / EN 61643-21
- All 8 signal lines (4 pair of wires) are protected simultaneously.
- EAC certification

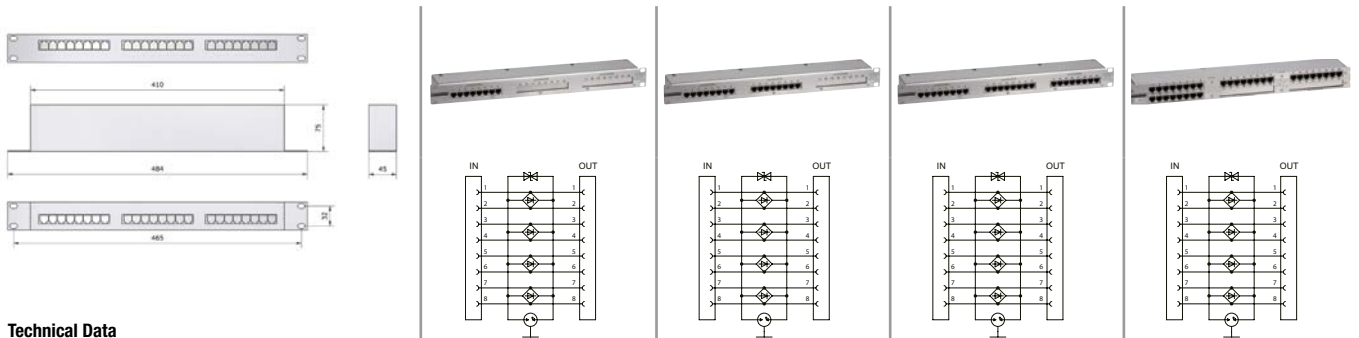

#### Technical Data

Product name	DP 1x8RJ45-19"	DP 2x8RJ45-19"	DP 3x8RJ45-19"	DP 4x8RJ45-19"
Article-No.	19 40 13	19 40 23	19 40 33	19 40 43
IEC category	C2 / C1 / C3	C2 / C1 / C3	C2 / C1 / C3	C2 / C1 / C3
Nominal voltage DC	UN 6 V=	6 V=	6 V=	6 V=
Max. continuous operating voltage DC	Uc 8,1 V=	8,1 V=	8,1 V=	
Nominal current per line	IL 100 mA	100 mA	100 mA	100 mA
C1 nominal discharge current (8/20 μs) per line	In 200 A	200 A	200 A	200 A
C2 Total discharge current (8/20 μs) line-earth (PE)	Imax 2,5 kA	2,5 kA	2,5 kA	2,5 kA
C1 protection level line-line at In	Up ≤ 45 V	≤ 45 V	≤ 45 V	≤ 45 V
C1 protection level line-earth at In	Up ≤ 350 V	≤ 350 V	≤ 350 V	≤ 350 V
C3 protection level line-line at 1kV/μs	Up ≤ 40 V	≤ 40 V	≤ 40 V	≤ 40 V
C3 protection level line-earth at 1kV/μs	Up ≤ 350 V	≤ 350 V	≤ 350 V	≤ 350 V
Response time line-line/ line-shield	tA < 1 ns	< 1 ns	< 1 ns	< 1 ns
Response time line-earth/ earth-shield	tA < 100 ns	< 100 ns	< 100 ns	< 100 ns
Max. frequency	fG 100 MHz	100 MHz	100 MHz	100 MHz
Operating temperature range	TU -40 - +80 °C	-40 - +80 °C	-40 - +80 °C	-40 - +80 °C
Terminal input/output	8 x RJ 45, shielded	16 x RJ 45, shielded	24 x RJ 45, shielded	32 x RJ 45, shielded
Degree of protection (IEC EN 60529)	IP 20	IP 20	IP 20	IP 20
Housing material	Stainless steel	Stainless steel	Stainless steel	Stainless steel



# SURGE PROTECTION FOR INFORMATION TECHNOLOGY AND TELECOMMUNICATION

## SPD FOR COMMUNICATION NETWORKS

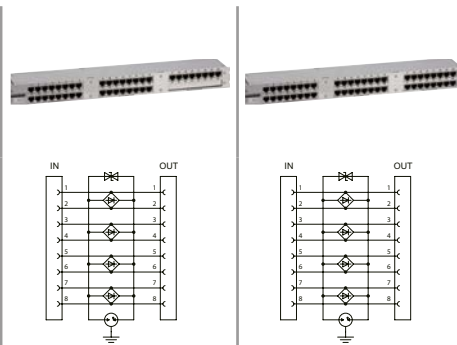

### Technical Data

Product name	DP 5x8RJ45-19 <sup>4</sup>	DP 6x8RJ45-19 <sup>4</sup>
Article-No.	19 40 53	19 40 63
IEC category	C2 / C1 / C3	C2 / C1 / C3
Nominal voltage DC	UN 6 V=	6 V=
Max. continuous operating voltage DC	Uc 8,1 V=	8,1 V=
Nominal current per line	IL 100 mA	100 mA
C1 nominal discharge current (8/20 μs) per line	In 200 A	200 A
C2 Total discharge current (8/20 μs) line-earth (PE)	I <sub>max</sub> 2,5 kA	2,5 kA
C1 protection level line-line at In	Up ≤ 45 V	≤ 45 V
C1 protection level line-earth at In	Up ≤ 350 V	≤ 350 V
C3 protection level line-line at 1kV/μs	Up ≤ 40 V	≤ 40 V
C3 protection level line-earth at 1kV/μs	Up ≤ 350 V	≤ 350 V
Response time Line-line/ line-shield	tA < 1 ns	< 1 ns
Response time Line-PE / PE-Schirm	tA < 100 ns	< 100 ns
Max. frequency	fG 100 MHz	100 MHz
Operating temperature range	TU -40 - +80 °C	-40 - +80 °C
Terminal input/output	40 x RJ 45, shielded	48 x RJ 45, shielded
Degree of protection (IEC EN 60529)	IP 20	IP 20
Housing material	Stainless steel	Stainless steel



### SPD for telecommunication networks

#### DataPro-TAE/NFN-aP

Surge protective device in a housing for surface mounting for the protection of analog telecommunication wires such as analog TAE or DSL interfaces.

- For analog telephone lines
- Fax, modem, answering machine
- Emergency dialling devices
- Applicable at the boundaries LPZ 0B - 2 and higher.
- TAE connector, code NFN
- Standard of the Deutsche Telekom
- Test standards: IEC 61643-21 / EN 61643-21
- 2-stage, (5-point) coarse and fine protective circuit
- EAC certification

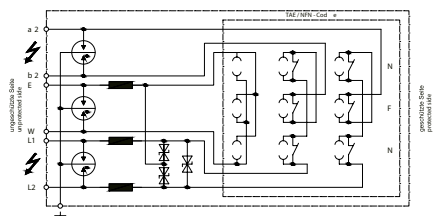

#### Technical Data

Product name	DataPro-TAE/NFN-aP	
Article-No.	24 00 04	
IEC category	C2 / C1 / C3	
Nominal voltage DC	UN	60 V=
Max. continuous operating voltage DC	Uc	185 V=
Nominal current	IL	1,5 A
C2 nominal discharge current (8/20 μs) total	I <sub>max</sub>	5 kA
Protection level at In (line-line)	Up	≤ 300 V
Protection level at In (line-earth)	Up	≤ 450 V
Response time (line-line)/(line-earth)	t <sub>A</sub>	≤ 10 / ≤ 50 ns
Max. frequency (-3 dB)	f <sub>G</sub>	1,5 MHz
Resistance per path	R	1 Ω
Operating temperature range	TU	-40 - +80 °C
Type of connection	Screw-type terminal/TAE	
Degree of protection (IEC EN 60529)	IP 20	

#### DataPro RS

Surge voltage arrester for serial interfaces RS232/RS422/RS485. The multi pole surge protective plug adapter make serial interfaces of computers or control systems secure of transient overvoltages.

- Pluggable surge voltage fine protection
- Protection against transverse surges as well as longitudinal surges
- Very fast response time
- Protection of all active pins
- Easy installation as adapter plug/socket
- Suitable for retrofitting
- Integrated earthing conductor
- EAC certification

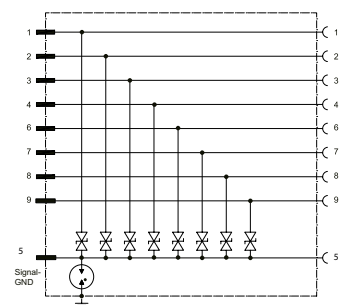

#### Technical Data

Product name	DP RS 232/422/485-9P	
Article-No.	24 00 60	
Nominal voltage DC	UN	15 V=
Max. continuous operating voltage DC	Uc	17 V=
C2 nominal discharge current (8/20 μs) line-line	I <sub>n</sub>	0,5 kA
C2 Nennableitstrom Line-Erde	I <sub>n</sub>	5 kA
Protection level at In (line-line)	Up	≤ 880 V
Protection level at In (line-earth)	Up	≤ 44 V
Response time line-line or line-GND	t <sub>A</sub>	<1 ns
Response time line-PE or GND-PE	t <sub>A</sub>	<100 ns
Max. transmission frequency	f <sub>G</sub>	13 MHz
Max. transmission rate	V <sub>s</sub>	10 Mbit/s
Protected lines	9	
Cross section of earthing conductor	2,5 mm <sup>2</sup>	
Operating temperature range	TU	-40 - +80 °C
Type of connection	D SUB 9	
Enclosure material / colour	ABS	
Degree of protection (IEC EN 60529)	IP 20	
Dimensions (L x W x H)	53 x 33 x 16 mm	



# SURGE PROTECTION FOR INFORMATION TECHNOLOGY AND TELECOMMUNICATION

## SURGE PROTECTIVE DEVICES FOR LSA MOUNTING

- LSA surge voltage magazines with 10 or 20 gas-filled surge arresters (coarse protection)
- Applicable at the LPZ transition point OA -1 and higher, depending on type
- The magazines can be connected to both the connection and the disconnection module

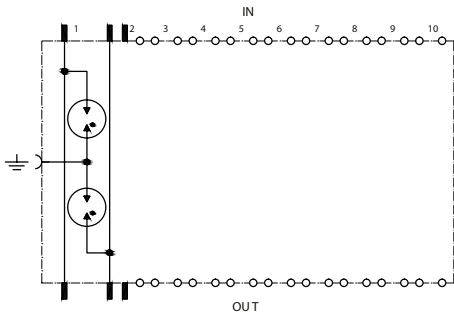

1 DA

- 
- 
- 
- 

10 DA

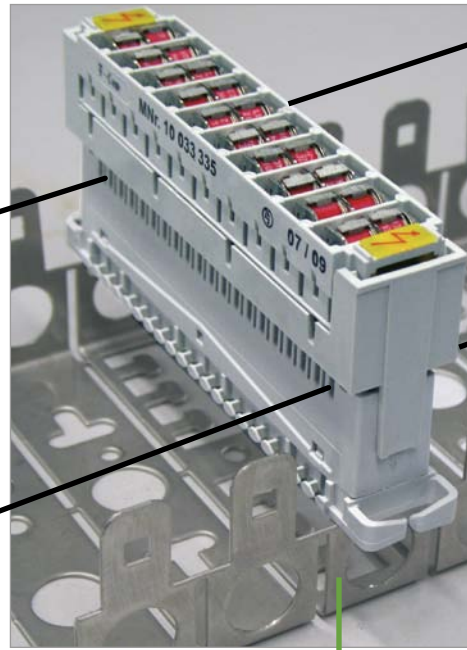

- Surge voltage protection connector (coarse and fine protection) DP 1LSA or DP 10LSA to equip the LSA disconnection module (white) of the construction form 2.
- Applicable at the LPZ transition point OA - 1 and higher, depending on type
- The surge voltage protection connectors are only pluggable to the disconnection module.
- Earthing by a grounding bar, which is connected to the backmount frame via the disconnection module.

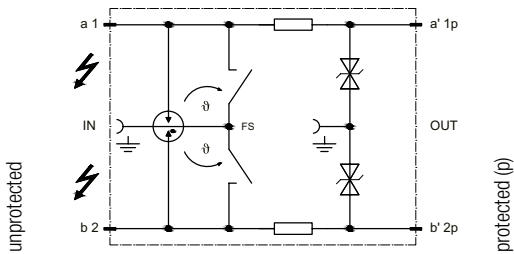

example: DP 1LSA-12

1 DA

- 
- 
- 
- 

10 DA

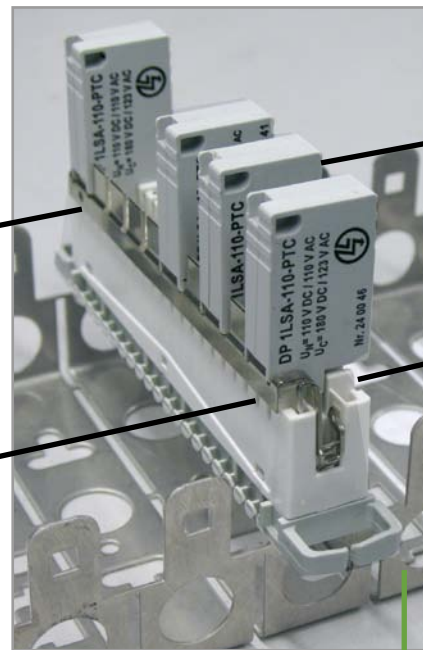





### SPD according to test category D1+C2

#### TelPro LSA 2/10-2E 8x6

LSA surge voltage protection for two-electrode arresters (8x6 mm) for LSA (IDC) connection and disconnection modules.



example image

- Empty and filled magazines
- Magazines are fitted with 20 gas-filled surge arresters (GDT) each

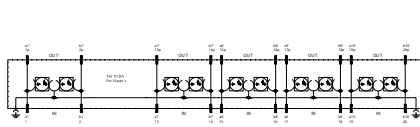

Product name		TelPro LSA 2/10-2E 8x6	TelPro LSA-2EH230-10kA	TelPro LSA-2EH230F-10kA	TelPro LSA-2EL230-20kA
Article-No.		24 01 06	24 01 13	24 01 14	24 01 15
Nominal DC sparkover voltage	U <sub>agN</sub>	-	230 V=	230 V=	230 V=
Nominal alternating discharge current	I <sub>wn</sub>	-	10 A	10 A	20 A
Impulse sparkover voltage typ. at 1 kV/μs	U <sub>as</sub>	-	< 650 V=	< 650 V=	< 550 V=
D1 lightning impulse current (10/350 μs)	I <sub>imp</sub>	-	2,5 kA	2,5 kA	5 kA
C2 nominal discharge current (8/20 μs)	I <sub>n</sub>	-	10 kA	10 kA	20 kA
C3 protection level line-earth at 1kV/μs	U <sub>p</sub>	-	≤ 650 V	≤ 650 V	≤ 550 V
Capacitance, line-earth	C	-	≤ 1,5 pF at 1MHz	≤ 1,5 pF at 1MHz	≤ 1,5 pF at 1MHz
Operating temperature range	TU	-40 - +80 °C	-40 - +80 °C	-40 - +80 °C	-40 - +80 °C

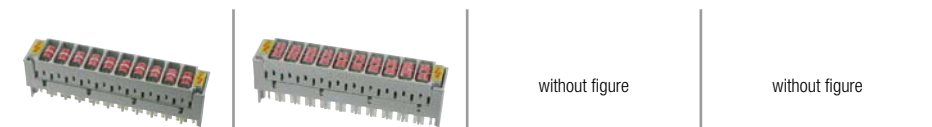
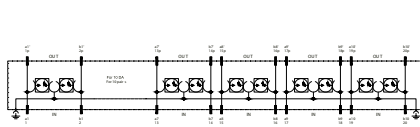

Product name		TelPro LSA-2EH350-10kA	TelPro LSA-2EH90-10kA	TelPro LSA-2EL90-20kA	TelPro LSA-2EL350-20kA
Article-No.		24 01 16	24 01 17	24 01 54	24 01 56
Nominal DC sparkover voltage	U <sub>agN</sub>	350 V=	90 V=	90 V=	350 V=
Impulse sparkover voltage typ. at 1 kV/μs	U <sub>as</sub>	< 800 V=	< 550 V=	< 550 V=	< 700 V=
Nominal alternating discharge current	I <sub>wn</sub>	20 A	10 A	20 A	20 A
D1 lightning impulse current (10/350 μs)	I <sub>imp</sub>	2,5 kA	2,5 kA	5 kA	5 kA
C2 nominal discharge current (8/20 μs)	I <sub>n</sub>	10 kA	10 kA	20 kA	20 kA
C3 protection level line-earth at 1kV/μs	U <sub>p</sub>	≤ 800 V	≤ 550 V	≤ 550 V	≤ 700 V
Capacitance, line-earth	C	≤ 1,5 pF at 1MHz	≤ 1,5 pF at 1MHz	≤ 1,5 pF at 1MHz	≤ 1,5 pF at 1MHz
Operating temperature range	TU	-40 - +80 °C	-40 - +80 °C	-40 - +80 °C	-40 - +80 °C



### SPD according to test category D1+C2

#### TelPro LSA 2/10-3E 8x13

LSA surge voltage protection for three-electrode arresters (8x13 mm or 8x10 mm) for LSA (IDC) connection and disconnection modules.



example image

- Empty and filled magazines
- Magazines are fitted with 10 gas-filled surge arrester (GDT) each
- Integrated fail-safe function

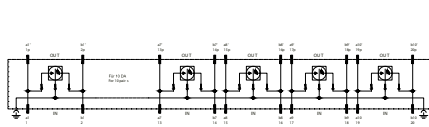

Product name	TelPro LSA 2/10-3E 8x13	TelPro LSA 2/10-3EH230E-10kA	TelPro LSA-3EH230F1E-10kA	TelPro LSA-3EL230E-20kA
Article-No.	24 01 18	24 01 19	24 01 23	24 01 24
Nominal DC sparkover voltage	UagN -	230 V=	230 V=	230 V=
Impulse sparkover voltage typ. at 1 kV/μs	Uas -	< 650 V=	< 650 V=	< 550 V=
Nominal alternating discharge current	Iwn -	10 A	10 A	20 A
D1 lightning impulse current (10/350 μs) total	Itotal -	5 kA	5 kA	10 kA
D1 lightning impulse current (10/350 μs) per line	Iimp -	2,5 kA	2,5 kA	5 kA
C2 nominal discharge current (8/20 μs) total	Imax -	10 kA	10 kA	20 kA
C2 nominal discharge current (8/20 μs) per line	In -	5 kA	5 kA	10 kA
C3 protection level line-line at 1kV/μs	Up -	≤ 500 V	≤ 500 V	≤ 500 V
C3 protection level line-earth at 1kV/μs	Up -	≤ 500 V	≤ 500 V	≤ 500 V
Capacitance, line-earth	C -	≤ 1,5 pF at 1MHz	≤ 1,5 pF at 1MHz	≤ 1,5 pF at 1MHz
Operating temperature range	TU -40 - +80 °C	-40 - +80 °C	-40 - +80 °C	-40 - +80 °C

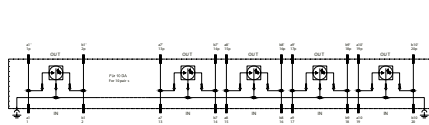

Product name	TelPro LSA-3EL230F1E-20kA	TelPro LSA-3EH90E-10kA	TelPro LSA-3EH90F1E-10kA
Article-No.	24 01 25	24 01 26	24 01 27
Nominal DC sparkover voltage	UagN 230 V=	90 V=	90 V=
Impulse sparkover voltage typ. at 1 kV/μs	Uas < 550 V=	< 550 V=	< 550 V=
Nominal alternating discharge current	Iwn 20 A	10 A	10 A
D1 lightning impulse current (10/350 μs) total	Itotal 10 kA	5 kA	5 kA
D1 lightning impulse current (10/350 μs) per line	Iimp 5 kA	2,5 kA	2,5 kA
C2 nominal discharge current (8/20 μs) total	Imax 20 kA	10 kA	10 kA
C2 nominal discharge current (8/20 μs) per line	In 10 kA	5 kA	5 kA
C3 protection level line-line at 1kV/μs	Up ≤ 500 V	≤ 450 V	≤ 500 V
C3 protection level line-earth at 1kV/μs	Up ≤ 500 V	≤ 450 V	≤ 500 V
Capacitance, line-earth	C ≤ 1,5 pF ( 1MHz)	≤ 1,5 pF at 1MHz	≤ 1,5 pF at 1MHz
Operating temperature range	TU -40 - +80 °C	-40 - +80 °C	-40 - +80 °C



### SPD according to test category D1+C2

#### MTH/MTL-Serie

The surge protection magazines of series MTH and MTL are fitted with high quality gas discharge tubes. They are available in variations of 90 Volt ac and 230 Volt ac executions.

They are designed specially for HVT 71 application of Siemens main distribution in telecom and data line systems. The integrated fail-safe behaviour protects against dangerous ac influences.



example image

- Magazines are fitted with 10 gas-filled surge arrester (GDT) each
  - Stable performance, long service life
- Impulse current resistance 10 kA or 20 kA per line
  - For five double lines

#### Technical Data

Product name	MTH 90	MTH 230	MTL 90	MTL 230
Article-No.	95 15 00	95 15 01	95 15 02	95 15 03
Nominal DC sparkover voltage at 100V/s	V <sub>sdCN</sub> 90 V=	230 V=	90 V=	230 V=
Tolerance of V <sub>sdCN</sub>	± 20 %	± 20 %	± 20 %	± 20 %
Impulse sparkover voltage typ. at 100 V/μs	U <sub>as</sub> < 450 V=	< 500 V=	< 450 V=	< 500 V=
Impulse sparkover voltage typ. at 1 kV/μs	U <sub>as</sub> < 550 V=	< 650 V=	< 550 V=	< 650 V=
Nom. impulse discharge current (8/20 μs) GDT/magazine	I <sub>n</sub> 10/5 kA	10/5 kA	20/5 kA	20/5 kA
Max. impulse discharge current (8/20) GDT/magazine	I <sub>max</sub> 12/7,5 kA	12/7,5 kA	25/7,5 kA	25/7,5 kA
Nominal alternating discharge current (50Hz)	5 A	5 A	5 A	5 A
Alternating discharge current 9 cycles, 50Hz	I <sub>wn</sub> 65 A	65 A	100 A	100 A
Glow voltage (average at 10 mA)	U <sub>gl</sub> 60 V	60 V	60 V	60 V
Arc - voltage at 1 A	U <sub>bo</sub> 15 V	15 V	15 V	15 V
Max. Operating current	I <sub>L</sub> 2 A	2 A	2 A	2 A
Insulation resistance	R <sub>isol</sub> > 10 GΩ	> 10 GΩ	> 10 GΩ	> 10 GΩ
Capacitance at 1 MHz	C < 1,5 pF	< 1,5 pF	< 1,5 pF	< 1,5 pF
Climatic category / Relative humidity (DIN IEC 60068-1)	40/90/21, 10%...95% rh	40/90/21, 10%...90% rh	40/90/21, 10%...95% rh	40/90/21, 10%...95% rh
Operating temperature range	TU -40 - +90 °C	-40 - +90 °C	-40 - +90 °C	-40 - +90 °C
Dimensions (L x W x H)	95,8 x 48,6 x 9 mm	95,8 x 48,6 x 9 mm	95,8 x 48,6 x 9 mm	95,8 x 48,6 x 9 mm
Material	Fiber glass reinforced, high temp. resistance (160°C) flame retarding plastic (PBF crastin)			



### SPD according to test category C2+C1

#### DataPro 1LSA

Surge voltage protective module for one pair of wires for measuring and control systems, in LSA (IDC) disconnection modules. The protective module provides coarse and fine protection in LSA systems (construction form 2). Surge voltage protection connector for 1DA, with fail-safe contact.

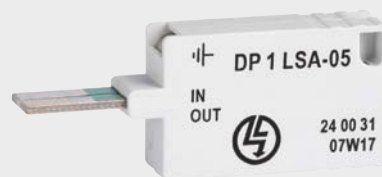

example image

- Versions for various voltage levels
- Two-step, coarse and fine protection
- Fail-safe thermal overload protection

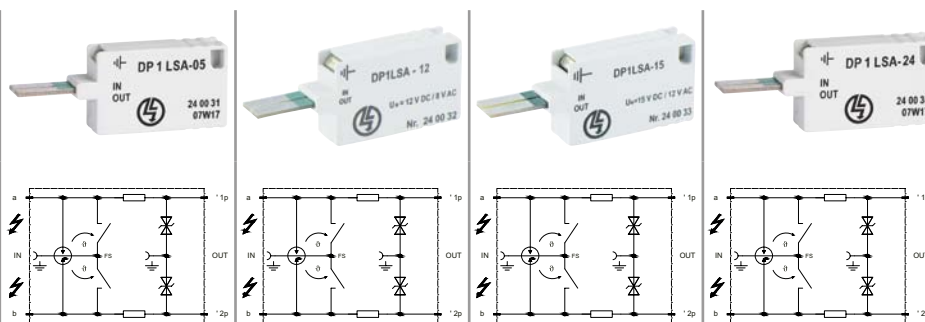
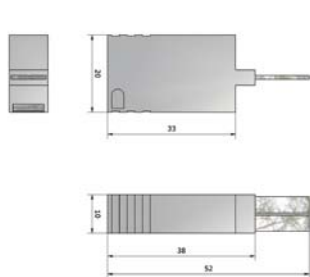

#### Technical Data

Product name	DP 1LSA-5	DP 1LSA-12	DP 1LSA-15	DP 1LSA-24
Article-No.	24 00 31	24 00 32	24 00 33	24 00 34
Nominal voltage DC	UN 5 V=	12 V=	15 V=	24 V=
Max. continuous operating voltage DC	Uc 6 V=	14 V=	19 V=	29 V=
Nominal voltage AC	UN 3 V~	8 V~	12 V~	15 V~
Max. continuous operating voltage AC (50/60Hz)	Uc 4 V~	10 V~	12 V~	20 V~
Nom. Operating current at 25° C	IL 150 mA	150 mA	150 mA	100 mA
C2 nominal discharge current (8/20 μs)	In 5 kA	5 kA	5 kA	5 kA
Max. impulse discharge current (8/20 μs)	Imax 10 kA	10 kA	10 kA	10 kA
Protection level at In (line-earth)	Up ≤ 15 V	≤ 28 V	≤ 40 V	≤ 60 V
Residual voltage at 1 kV/μs (line-earth)	Ures ≤ 12 V	≤ 22 V	≤ 31 V	≤ 46 V
Response time	tA ≤ 1 ns	≤ 1 ns	≤ 1 ns	≤ 1 ns
Capacitance, line-earth	C ≤ 4,5 nF	≤ 2,5 nF	≤ 2 nF	≤ 1,4 nF
Series impedance per line at 25°C	R 10 Ω	15 Ω	22 Ω	27 Ω
Max. transmission frequency	fg 1,6 MHz	2,4 MHz	3,1 MHz	4,2 MHz
Operating temperature range	TU -25 - +60 °C	-25 - +60 °C	-25 - +60 °C	-25 - +60 °C
Earthing (Grounding) by	via grounding bar and isolation unit on LSA backmount frame		via grounding bar and isolation unit on LSA backmount frame	
Enclosure material / colour	self-extinguishing thermoplastic (POCAN) UL 94 V0, grey		self-extinguishing thermoplastic (POCAN) UL 94 V0, grey	
IEC category	C2 / C1	C2 / C1	C2 / C1	C2 / C1

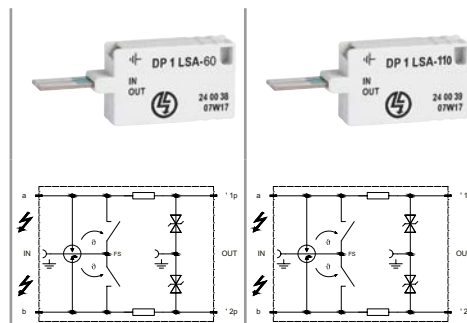

### Technical Data

Product name	DP 1LSA-60	DP 1LSA-110
Article-No.	24 00 38	24 00 39
IEC category	C2 / C1	C2 / C1
Nominal voltage DC	UN 60 V=	110 V=
Max. continuous operating voltage DC	Uc 100 V=	180 V=
Nominal voltage AC	UN 48 V~	110 V~
Max. continuous operating voltage AC (50/60Hz)	Uc 70 V~	123 V~
Nom. Operating current at 25° C	IL 150 mA	150 mA
C2 nominal discharge current (8/20 μs)	In 5 kA	5 kA
Max. impulse discharge current (8/20 μs)	I <sub>max</sub> 10 kA	10 kA
Protection level at In (line-earth)	Up ≤ 300 V	≤ 600 V
Residual voltage at 1 kV/μs (line-earth)	U <sub>res</sub> ≤ 180 V	≤ 230 V
Response time	t <sub>A</sub> ≤ 25 ns	≤ 25 ns
Capacitance, line-earth	C ≤ 0,25 nF	≤ 0,1 nF
Series impedance per line at 25°C	R 4,7 Ω	4,7 Ω
Max. transmission frequency	f <sub>g</sub> 5 MHz	10 MHz
Operating temperature range	TU -25 - +60 °C	-25 - +60 °C
Earthing (Grounding) by	via grounding bar and isolation unit on LSA backmount frame	
Enclosure material / colour	self-extinguishing thermoplastic (POCAN) UL 94 V0, grey	



### SPD according to test category C2+C1

#### DataPro 1LSA + PTC

Surge protection device for data and signal lines in measuring systems and automatic control devices. Surge voltage protection connector for 1 DA, with surge current protection via PTC thermistors and fail-safe contact for LSA (IDC) disconnection modules.

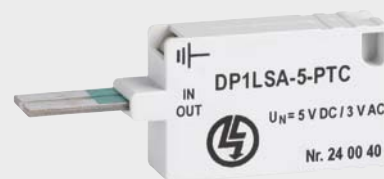

example image

- Coarse and fine protection
- Surge current protection via PTC thermistors
- Suitable for DC and AC application

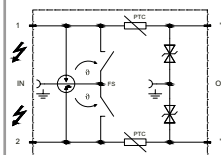
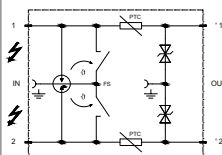
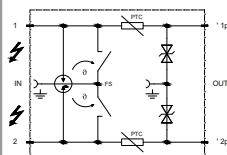
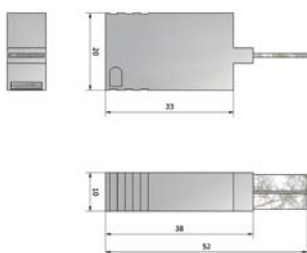

#### Technical Data

Product name	DP 1LSA-5-PTC	DP 1LSA-12-PTC	DP 1LSA-24-PTC
Article-No.	24 00 40	24 00 41	24 00 43
IEC category	C2 / C1	C2 / C1	C2 / C1
Nominal voltage DC	UN 5 V=	12 V=	24 V=
Max. continuous operating voltage DC	UC 6 V=	14 V=	29 V=
Nominal voltage AC	UN 3 V~	8 V~	15 V~
Max. continuous operating voltage AC (50/60Hz)	UC 4 V~	10 V~	20 V~
Nom. Operating current at 25° C	IL 150 mA	150 mA	150 mA
C2 nominal discharge current (8/20 μs)	In 5 kA	5 kA	5 kA
Max. impulse discharge current (8/20 μs)	Imax 10 kA	10 kA	10 kA
Protection level at In (line-earth)	Up ≤ 15 V	≤ 28 V	≤ 60 V
Residual voltage at 1 kV/μs (line-earth)	Ures ≤ 12 V	≤ 22 V	≤ 46 V
Response time	tA ≤ 1 ns	≤ 1 ns	≤ 1 ns
Thermal overload protection	Thermal fail-safe (short-circuit spring) and PTC		Thermal fail-safe (short-circuit spring) and PTC
Capacitance, line-earth	C ≤ 4,5 nF	≤ 2,5 nF	≤ 1,4 nF
Series impedance per line at 25°C	R 9 - 11 Ω	9 - 11 Ω	9 - 11 Ω
Max. transmission frequency	fg 1,6 MHz	2,4 MHz	4,2 MHz
Operating temperature range	TU -25 - +60 °C	-25 - +60 °C	-20 - +60 °C
Earthing (Grounding) by	via grounding bar and isolation unit on LSA backmount frame		via grounding bar and isolation unit on LSA backmount frame

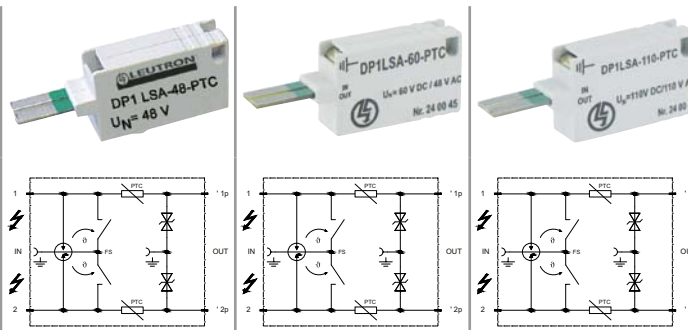

### Technical Data

Product name	DP 1LSA-48-PTC	DP 1LSA-60-PTC	DP 1LSA-110-PTC
Article-No.	24 00 44	24 00 45	24 00 46
IEC category	C2 / C1	C2 / C1	C2 / C1
Nominal voltage DC	UN 48 V=	60 V=	110 V=
Max. continuous operating voltage DC	Uc 80 V=	100 V=	180 V=
Nominal voltage AC	UN 24 V~	48 V~	110 V~
Max. continuous operating voltage AC (50/60Hz)	Uc 56 V~	70 V~	123 V~
Nom. Operating current at 25° C	IL 150 mA	150 mA	150 mA
C2 nominal discharge current (8/20 µs)	In 5 kA	5 kA	5 kA
Max. impulse discharge current (8/20 µs)	I <sub>max</sub> 10 kA	10 kA	10 kA
Protection level at In (line-earth)	Up ≤ 240 V	≤ 300 V	≤ 600 V
Residual voltage at 1 kV/µs (line-earth)	U <sub>res</sub> ≤ 130 V	≤ 180 V	≤ 230 V
Response time	tA ≤ 25 ns	≤ 25 ns	≤ 25 ns
Thermal overload protection	Thermal fail-safe (short-circuit spring) and PTC		Thermal fail-safe (short-circuit spring) and PTC
Capacitance, line-earth	C ≤ 300 nF	≤ 250 nF	≤ 100 nF
Series impedance per line at 25°C	R 9 - 11 Ω	9 - 11 Ω	9 - 11 Ω
Max. transmission frequency	fg 5 MHz	5 MHz	10 MHz
Operating temperature range	TU -25 - +60 °C	-25 - +60 °C	-25 - +60 °C
Earthing (Grounding) by	via grounding bar and isolation unit on LSA backmount frame		via grounding bar and isolation unit on LSA backmount frame

## DataPro 1LSA-T110FS-PTC

Surge voltage and surge current protection for communication and data transmission lines. Protection connector (1DA) with surge current protection via PTC thermistors, for analogue, ISDN and ADSL lines. Integrated coarse and fine protection and fail-safe contact.

- self-extinguishing thermoplastic (POCAN) UL 94 V0, grey
- Earthing by a grounding bar, which is connected to the backmount frame via the disconnection module.

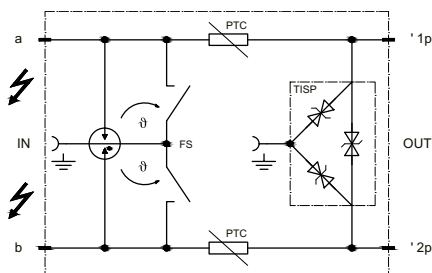

### Technical Data

Product name	DP 1LSA-T110FS-PTC
Article-No.	24 00 48
IEC category	C2 / C1
Nominal voltage DC	UN 110 V=
Max. continuous operating voltage DC	Uc 180 V=
Nom. Operating current at 25° C	IL 150 mA
C2 nominal discharge current (8/20 µs)	In 5 kA
Max. impulse discharge current (8/20 µs)	I <sub>max</sub> 10 kA
Protection level at In	Up ≤ 300 V
Residual voltage at 1 kV/µs (Line-earth, Line-Line)	U <sub>res</sub> ≤ 300 V
Response time	tA ≤ 5 ns
Transversal Capacitance	C ≤ 60 pF
Series impedance per line at 25°C	R 9 - 11 Ω
Max. transmission frequency	fg > 20 MHz
Thermal overload protection	Thermal fail-safe (short-circuit spring) and PTC
Operating temperature range	TU -25 - +60 °C



### SPD according to test category C2+C1

#### DataPro 1LSA-CxxFS-PTC

Surge voltage protector for data and signal lines in measuring systems and automatic control devices. Surge voltage protection connector for 1 DA with surge current protection via PTC thermistors and fail-safe contact for higher frequency transmission range for measuring systems and automatic control devices, for LSA (IDC) disconnection modules.



example image

- Surge current protection via PTC thermistors
- High impulse discharge current of 10 kA (8/20 μs)
- Suitable for DC and AC application

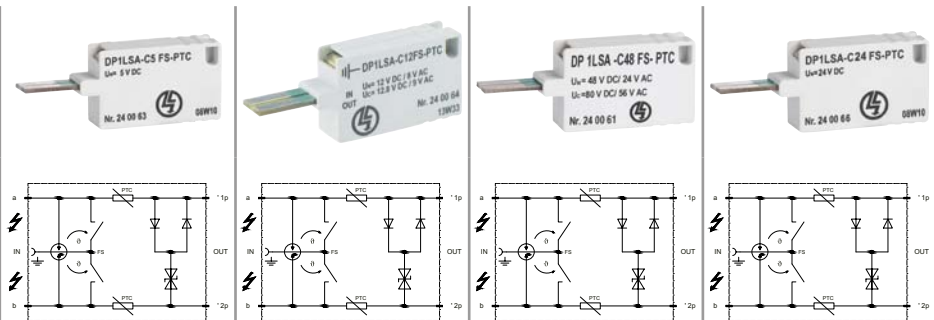
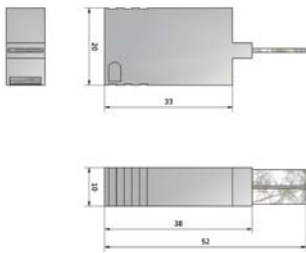

#### Technical Data

Product name	DP 1LSA-C5FS-PTC	DP 1LSA-C12FS-PTC	DP 1LSA-C15FS-PTC	DP 1LSA-C24FS-PTC
Article-No.	24 00 63	24 00 64	24 00 65	24 00 66
IEC category	C2 / C1	C2 / C1	C2 / C1	C2 / C1
Nominal voltage DC	UN 5 V=	12 V=	15 V=	24 V=
Nominal voltage AC	UN 4 V~	8 V~	12 V~	15 V~
Max. continuous operating voltage DC	UC 6 V=	14 V=	19 V=	29 V=
Max. continuous operating voltage AC (50/60Hz)	UC 4,5 V~	10 V~	12 V~	20 V~
Nom. Operating current at 25° C	IL 150 mA	150 mA	150 mA	150 mA
C2 nominal discharge current (8/20 μs)	In 5 kA	5 kA	5 kA	5 kA
Max. impulse discharge current (8/20 μs)	Imax 10 kA	10 kA	10 kA	10 kA
Protection level at In (line-line)	Up ≤ 11 V	≤ 22 V	≤ 31 V	≤ 46 V
Protection level at In (line-earth)	Up ≤ 600 V	≤ 600 V	≤ 600 V	≤ 600 V
Response time a-b	tA ≤ 1 ns	≤ 1 ns	≤ 1 ns	≤ 1 ns
Response time a, b to earth	100 ns	< 100 ns	< 100 ns	< 100 ns
Transversal Capacitance	C ≤ 30 pF	≤ 30 pF	≤ 30 pF	≤ 30 pF
Series impedance per line at 25°C	R 9 - 11 Ω	9 - 11 Ω	9 - 11 Ω	9 - 11 Ω
Max. transmission frequency	fg ≤ 30 MHz	≤ 30 MHz	≤ 30 MHz	≤ 30 MHz
Thermal overload protection	Thermal fail-safe (short-circuit spring) and PTC		Thermal fail-safe (short-circuit spring) and PTC	
Operating temperature range	TU -25 - +60 °C	-25 - +60 °C	-25 - +60 °C	-25 - +60 °C



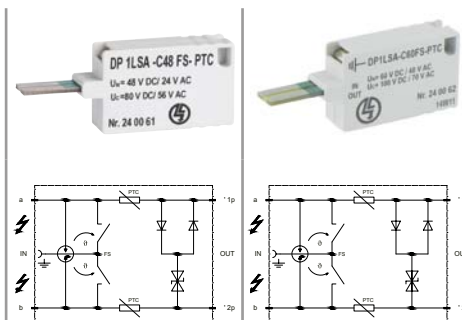

### Technical Data

Product name	DP 1LSA-C48FS-PTC	DP 1LSA-C60FS-PTC
Article-No.	24 00 61	24 00 62
IEC category	C2 / C1	C2 / C1
Nominal voltage DC	UN 48 V=	60 V=
Nominal voltage AC	UN 24 V~	48 V~
Max. continuous operating voltage DC	Uc 80 V=	100 V=
Max. continuous operating voltage AC (50/60Hz)	Uc 56 V~	70 V~
Nom. Operating current at 25° C	IL 150 mA	150 mA
C2 nominal discharge current (8/20 µs)	In 5 kA	5 kA
Max. impulse discharge current (8/20 µs)	Imax 10 kA	10 kA
Protection level at In (line-line)	Up ≤ 130 V	≤ 180 V
Protection level at In (line-earth)	Up ≤ 600 V	≤ 600 V
Response time a-b	tA ≤ 25 ns	≤ 25 ns
Response time a, b to earth	< 100 ns	<100 ns
Transversal Capacitance	C ≤ 30 pF	≤ 30 pF
Series impedance per line at 25°C	R 9 - 11 Ω	9 - 11 Ω
Max. transmission frequency	fg ≤ 30 MHz	≤ 30 MHz
Thermal overload protection	Thermal fail-safe (short-circuit spring) and PTC	
Operating temperature range	TU -25 - +60 °C	-25 - +60 °C

## DataPro 1LSA-TK180FS

Lightning and surge protection for telephone installations. Pluggable module for LSA (IDC) disconnection modules.

Surge voltage protection connector for 1 DA with fail-safe contact (only coarse protection) for analogue, ISDN and ADSL lines.

- self-extinguishing thermoplastic (POCAN) UL 94 V0, grey
- Earthing by a grounding bar, which is connected to the backmount frame via the disconnection module.

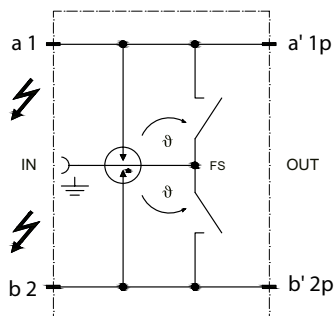

### Technical Data

Product name	DP 1LSA-TK180FS
Article-No.	24 00 49
IEC category	C2 / C1
Nominal voltage DC	UN 110 V=
Max. continuous operating voltage DC	Uc 180 V=
Max. continuous operating voltage AC (50/60Hz)	Uc 127 V~
Nominal DC sparkover voltage at 100V/s	UagN 230 ±20% V=
C3 Protection level at 1kV/µs (Line-earth)	Up ≤ 600 V
Nom. Operating current at 25° C	IL 1 A
C2 nominal discharge current (8/20 µs)	In 5 kA
Max. impulse discharge current (8/20 µs)	Imax 10 kA
Alternating discharge current 9 cycles, 50Hz	Iwn 40 A
Response time (Line-Line)/(Line-earth)	tA ≤ 50 ns
Self-capacitance line-earth at 1 MHz	C ≤ 5 pF
Max. transmission frequency	fg >30 MHz
Thermal overload protection	thermal fail-safe (short-circuit spring)
Operating temperature range	TU -25 - +60 °C



### SPD according to test category C2+C1

#### DataPro 10LSA-PTC

Pluggable surge voltage protection modules for 10-wire pairs for LSA (IDC) disconnection modules.



example image

- Surge voltage protection against longitudinal and transverse voltages
- Protection for up to ten pair of wires (DA)
- High transmission rate in range of MHz
- Coarse and fine protection (high speed TVS-diodes) for measuring and control systems

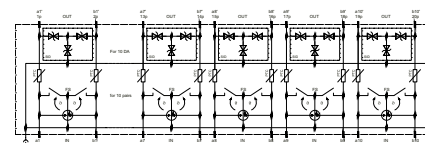
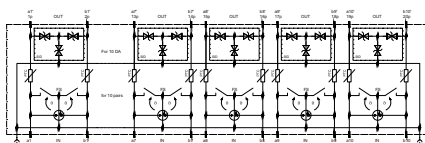
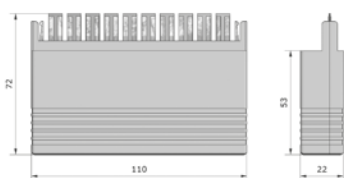

#### Technical Data

Product name	DP 10LSA-PTC-12V	DP 10LSA-PTC-24V	DP 10LSA-PTC-110
Article-No.	24 00 26	24 00 28	24 01 42
Nominal voltage DC	UN 12 V=	24 V=	110 V=
Max. continuous operating voltage DC	Uc 14 V=	29 V=	180 V=
Max. continuous operating voltage AC (50/60Hz)	Uc 10 V~	21 V~	180 V~
Residual voltage at 1 kV/μs	Ures ≤ 22 V	≤ 46 V	≤ 250 V
Nom. Operating current at 25° C	IL 150 mA	150 mA	145 mA
C2 nominal discharge current (8/20 μs)	In 5 kA	5 kA	5 kA
Max. impulse discharge current (8/20 μs)	Imax 10 kA	10 kA	10 kA
Protection level at In	Up ≤ 28 V	≤ 60 V	220 V
Response time	tA ≤ 1 ns	≤ 1 ns	≤ 1 ns
Capacitance, line-earth	C < 2,5 nF	< 1,4 nF	< 0,1 nF
Series impedance per line at 25°C	R 9 - 11 Ω	9 - 11 Ω	9 - 11 Ω
Max. transmission frequency	fg < 2,4 MHz	≤ 4,2 MHz	≤ 2 MHz
Operating temperature range	TU -40 - +80 °C	-40 - +80 °C	-40 - +80 °C
Thermal overload protection	Thermal fail-safe (short-circuit spring) and PTC		Thermal fail-safe (short-circuit spring) and PTC
Dimensions (L x W x H)	110 x 22 x 72 mm	110 x 22 x 72 mm	110 x 22 x 72 mm
Earthing (Grounding) by	via grounding bar and isolation unit on LSA backmount frame		via grounding bar and isolation unit on LSA backmount frame
Enclosure material / colour	Thermoplastic: grey	Thermoplastic: grey	Thermoplastic: grey

### Accessories for LSA Technology

#### LSA disconnection module

Each module can hold 10 DA at the cable and allocation side. To be equipped with surge voltage protection connectors (coarse and fine protection) DP 1LSA or DP 10LSA. Applicable at the LPZ transition point 1-2 and higher. The disconnection module is white.

<b>Technical Data</b>	
<b>Product name</b>	<b>LSA 2/10-TR</b>
Article-No.	24 01 02
Withstand voltage	2 kV
Volume resistance	< 10 mΩ
Conductor diameter	0,4 -0,8 mm
Insulation resistance	Risol 10 GΩ
External diameter of insulation	0,7-1,5 mm
Net weight / pc	55 g

#### LSA connection module

Each module can hold 10 DA at the cable and allocation side for a permanent connection. LSA magazines filled with gas-filled surge arresters can be plugged in. The connection module is grey.

<b>Technical Data</b>	
<b>Product name</b>	<b>LSA 2/10-AN</b>
Article-No.	24 01 00
Withstand voltage	2 kV
Volume resistance	< 10 mΩ
Conductor diameter, solid wire	0,4-0,8 AWG 26-20 mm
Insulation resistance	Risol 5x 10.000 MΩ
External diameter of insulation	0,7-1,5 mm
Net weight / pc	50 g

- Corresponds with IEC 60352-4 and DIN 41611-6
- Wiring with two wires of same diameter is possible
- Amply dimensioned elastic arrangement of the wiring

#### Further LSA parts



**LSA 2/10-ER38-rot** (Art.-No. 24 01 04)  
LSA Ground Module to connect 38 earthing connectors and shields.



**LSA 2/10-ES** (Art.-No. 24 01 33)  
Grounding rail, for 10 DA connection modules serving as connection between LSA backmount frame and 1 DA surge voltage (+surge current) - protection connector



**LSA 2/10 KS-120** (Art.-No. 24 01 36)  
LSA edge protection profile for backmount frame (plastic)



**LSA 2/10 KSR** (Art.-No. 24 01 08)  
LSA 2/10 hinged label holder (plastic)



**LSA 2/10-MW10-25/22** (Art.-No. 24 01 10)  
LSA backmount frame 10 x 10DA (modular) stainless metal. Plug space for 10 pcs of LSA 2/10 10DA connection modules (Σ 100 DA) 25 mm grid / depth 22 mm, easily detachable upon individual requirements, available up to a size of 78 connection modules.



**LSA DIN ADAPT** (Art.-No. 24 01 37)  
LSA 2/10 DIN rail adapter. Adapter metal line with M5 screw thread (without screw). Used to fix backmount frame or connection modules onto 35 mm DIN rails.



**LSA 2/10 AD** (Art.-No. 24 01 09)  
Magazine cover for protection against dust and unwanted contact; transparent

<b>Product name</b>	<b>LSA 2/10 KSR</b>	<b>LSA 2/10 AD</b>	<b>LSA 2/10-MW10-25/22</b>	<b>LSA DIN ADAPT</b>	<b>LSA 2/10 KS-120</b>	<b>LSA 2/10-ES</b>	<b>LSA 2/10-ER38-rot</b>
Article-No.	24 01 08	24 01 09	24 01 10	24 01 37	24 01 36	24 01 33	24 01 04

## EVERYTHING FOR THE PROTECTION OF TRANSMISSION AND RECEIVING SYSTEMS

Due to an expansion of its product range Leutron now offers devices that cover all established interfaces and frequency ranges. Transmitting and receiving systems with broadband and narrowband signals up to 6 GHz as well as base stations for mobile communications and broadcasting systems can be protected. The protective devices combine a very low protection level with an optimum transmission of the wanted signal.

**Special solutions for uncommon interfaces are available on request.**



### FAULT-FREE TRANSMITTING AND RECEIVING OPERATION:

- Protective devices with gas-filled surge protectors, impedance-adjusted for frequency ranges up to 6 GHz – simultaneous transmission of a DC supply voltage possible



## **SURGE PROTECTION FOR COAXIAL INTERFACES**

Versions for different interfaces:

- BNC connectors
- FME connectors
- SMA connectors
- N connectors
- DIN 7/16 connectors

Protection  
for different  
voltage levels

Versions up to 6 GHz  
available

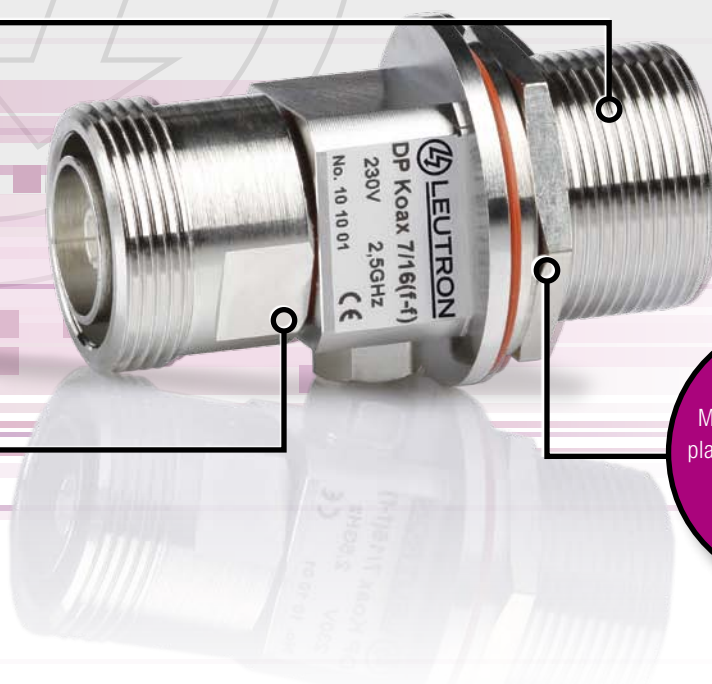

Mounting on mounting  
plate or as adapter plug/  
socket

## **SURGE PROTECTION FOR TRANSMITTING AND RECEIVING SYSTEMS**



# SURGE PROTECTION FOR TRANSMITTING AND RECEIVING SYSTEMS

## TABLE OF CONTENTS

Surge protection for transmitting and receiving systems		Page
<b>SPD with BNC connector</b>		<b>165</b>
DataPro Koax-8V-BNC	Frequency range 0 - 60 MHz	165
DataPro Koax BNC	Frequency range 0 - 6 GHz	166
<b>SPD with SMA connector</b>		<b>166</b>
DataPro-SMA-m/f	Frequency range 0 - 4 GHz	166
AntPro 5,8GHz-SMA	Frequency range 0 - 6 GHz	167
<b>SPD with FME connector</b>		<b>167</b>
DataPro FME-AD	Frequency range 0 - 6 GHz	167
<b>SPD with N connector</b>		<b>168</b>
AntPro Koax-GSM-N/230	Frequency range 0 - 2,5 GHz	168
AntPro 6GHz-N	Frequency range 0 - 6 GHz	169
<b>SPD with DIN 7/16 connector</b>		<b>170</b>
DataPro Koax 7/16	0 - 2,5 GHz	170
<b>TV, radio plug protection</b>		<b>171</b>
DP-SAT-F-5...2500MHz	5 - 2500 MHz	171



### DataPro Koax-8V-BNC

Lightning and surge protection for coaxial signal lines with BNC connector for the use at the building entry.



example image

- High performance surge protector
  - Applicable at the building entry at the boundaries LPZ 0A-1 and higher
  - For video surveillance cameras
  - Connector according to IEC 61169-8
- Grounding via connected earthing wire 0.75 mm<sup>2</sup>, L=ca.30 mm
  - Test standard: IEC 61643-21 / EN 61643-21

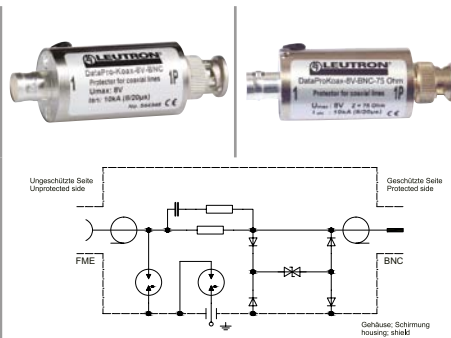
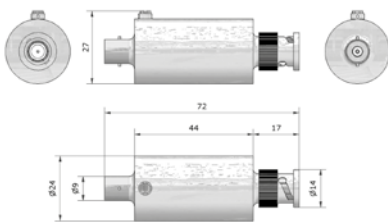

#### Technical Data

Product name	DataPro Koax-8V-BNC	DataPro Koax-8V-BNC-75 Ohm
Article-No.	54 43 46	54 43 40
IEC category	D1 / C2 / C1 / C3	D1 / C2 / C1 / C3
Max. continuous operating voltage DC	Uc 8 V=	8 V=
Max. power	0,7 W	0,7 W
Longitudinal impedance (DC resistance) per wire	Z 10 Ω	10 Ω
Surge impedance	50 Ω	75 Ω
Response time fine protection	tA ≤ 2 ns	≤ 2 ns
C2 nominal discharge current (8/20 μs)	In 5 kA	5 kA
Max. impulse discharge current (8/20 μs)	Imax 10 kA	10 kA
D1 lightning impulse current (10/350 μs)	Iimp 1 kA	1 kA
C2 protection level line-shield at In	Up ≤ 20 V	≤ 20 V
C3 protection level line-shield at 1kV/μs	Up ≤ 13 V	≤ 13 V
C3 protection level line-shield-PE at (1kV/μs)	Up ≤ 600 V	≤ 600 V
Frequency range	f0 0 - 60 MHz	0 - 60 MHz
Return loss	RL bei 40 kHz: > 20 dB	
Operating temperature range	TU - 25 - +85 °C	-25 - +85 °C
Degree of protection (IEC EN 60529)	IP 20	IP 20
Plug connector	BNC (m/f)	BNC (m/f)



### DataPro Koax BNC

Surge protection device for coaxial signal lines with BNC connectors and very high frequencies. The discharge current arrester can be mounted in and earthed in a mounting plate.

- Surge protection device for extremely high frequencies up to 6 GHz
- Applicable at the boundaries LPZ 0B - 1 and higher
- Connector according to IEC 61169-8
- Earthing via metal housing
- Test standard: IEC 61643-21 / EN 61643-21

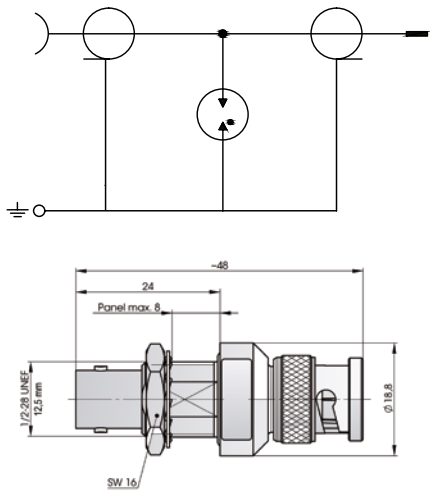



	
<b>Technical Data</b>	
<b>Product name</b>	<b>DP Koax BNC 500hm</b>
Article-No.	54 43 30
IEC category	C2 / C1 / C3
Surge impedance	Z 50 Ω
Frequency range	f0 0 - 6000 MHz
Return loss	RL ≥ 20 dB
Breakdown voltage (100V/s)	150 - 250 V
C2 nominal discharge current (8/20 μs)	I <sub>n</sub> 5 kA
Max. impulse discharge current (8/20 μs)	I <sub>max</sub> 10 kA
Max. transmission capacity	25 W
Operating temperature range	TU -40 - +85 °C
Degree of protection (IEC EN 60529)	IP 67
Plug connector	BNC (m/f)

### DataPro-SMA-m/f

Lightning protection for HF systems/ DC power systems with SMA connectors

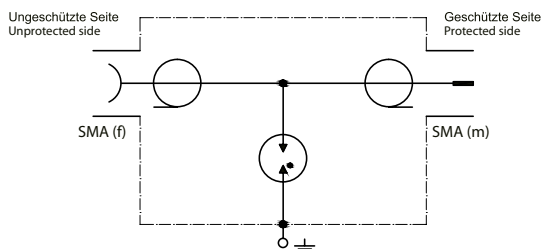
- High performance surge protector
- Small designed
- Maximal operating voltage of 10 V DC
- Frequency range: DC - 4 GHz



	
<b>Technical Data</b>	
<b>Product name</b>	<b>DP-SMA-m/f</b>
Article-No.	54 43 57
IEC category	C2 / C1
Max. continuous operating voltage DC	U <sub>c</sub> 10 V=
Lightning impulse current (10/350 μs)	I <sub>imp</sub> 5 kA
C2 nominal discharge current (8/20 μs)	I <sub>n</sub> 20 kA
Protection level (line-earth)	U <sub>p</sub> < 650 V
Max. power transfer	P <sub>max</sub> 25 W
Frequency range	f0 0-4000 MHz
Insertion loss	fE 0,2 dB
Surge impedance	Z 50 Ω
Operating temperature range	TU -40 - +80 °C
Plug connector	SMA (m/f)
Enclosure material / colour	brass CuZnSN





## AntPro 5,8GHz-SMA / DataPro FME-AD

Surge protection device for coaxial signal lines with SMA connectors. The very high frequency range of up to 6 GHz enables the use in wireless LAN and similar applications. The discharge current arrester can be mounted in and earthed in a mounting plate.

DP FMA-AD: Surge voltage protection for sensitive GSM modems with FME antenna connector. The set contains an discharge current arrester with SMA connector and a frequency range up to 6 GHz and adapters for FME connectors.



example image

- Surge protection device for extremely high frequencies up to 6 GHz
- Applicable at the boundaries LPZ 0B - 1 and higher
- Connector according to IEC 61169-8
- Earthing via metal housing
- Test standard: IEC 61643-21 / EN 61643-21
- Mounting with angle bracket or in mounting plate possible
- Second version with inverse polarity (inner conductor is socket instead of plug)

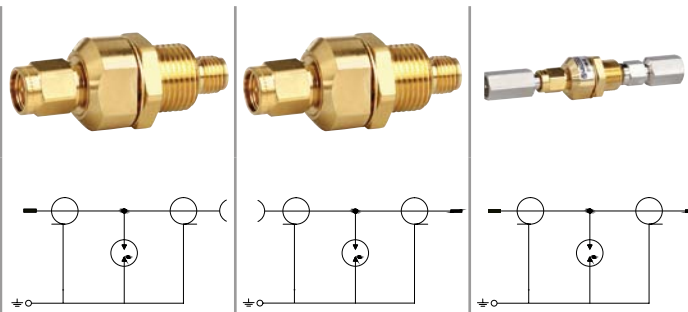
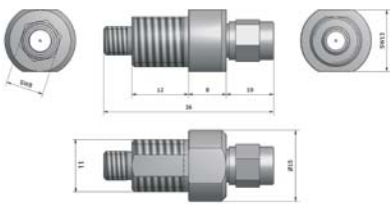

### Technical Data

Product name	AntPro 5,8GHz-SMA	AntPro 5,8GHz-R-SMA	DP FME-AD
Article-No.	04 58 00	04 58 02	16 05 20
IEC category	C1 / C2 / C3	C1 / C2 / C3	C1 / C2 / C3
Surge impedance	Z 50 Ω	50 Ω	50 Ω
Frequency range	f0 0 - 6000 MHz	0 - 6000 MHz	0 - 6000 MHz
Return loss	RL ≥ 20 dB	≥ 20 dB	≥ 20 dB
Breakdown voltage (100V/s)	150 - 250 V	150 - 250 V	150 - 250 V
C2 nominal discharge current (8/20 μs)	I <sub>n</sub> 5 kA	5 kA	5 kA
Max. impulse discharge current (8/20 μs)	I <sub>max</sub> 10 kA	10 kA	10 kA
Max. transmission capacity	25 W	25 W	25 W
Operating temperature range	TU -40 - +85 °C	-40 - +85 °C	-40 - +80 °C
Plug connector	SMA (m/f)	R-SMA (f/m)	FME (m/m)



### AntPro Koax-GSM-N/230

AntPro Koax-GSM-N was designed for the coarse protection of highly sensitive electrical HF amplifiers, e.g., for GSM aerial systems with GSM aerial cable RG213/U (max. 180 W at max. 1 GHz, Ø 10.5 mm).



example image

- High performance surge arrester for broadband applications with frequency ranges from DC up to 2.5 GHz
- Applicable at the boundaries LPZ 0B - 1 and higher
- Connector according to IEC 61169-8
- Test standard: IEC 61643-21 / EN 61643-21
- The f/f version can be mounted in a mounting plate or with an angle bracket.
- With holder „MW-AntPro“ (metall) - see below

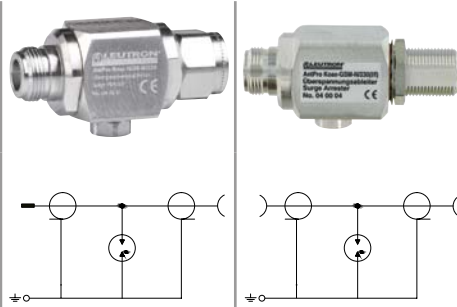
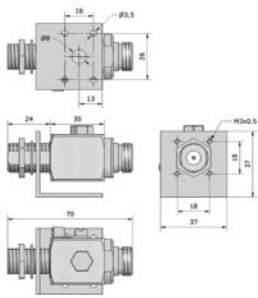

#### Technical Data

Product name	AntPro Koax-GSM-N/230	AntPro Koax-GSM-N/230(f/f)
Article-No.	04 00 01	04 00 04
IEC category	C1 / C2 / C3	C1 / C2 / C3
Surge impedance	Z 50 Ω	50 Ω
Frequency range	f0 0 - 2500 MHz	0 - 2500 MHz
Return loss	RL	typ.: 1GHz: 30 dB / 2,5GHz: 23 dB
Insertion loss	fE	typ.: 1GHz<0,1 dB / 2,5GHz<0,2 dB
DC spark-over voltage	230 V	230 V
C2 nominal discharge current (8/20 μs)	I <sub>n</sub> 15 kA	15 kA
Max. impulse discharge current (8/20 μs)	I <sub>max</sub> 20 kA	20 kA
Insulation resistance	R <sub>isol</sub> ≥ 5 GΩ	≥ 5 GΩ
Vertical resistance inner conductor	R ≤ 2 mΩ	≤ 2 mΩ
Vertical resistance outer conductor	R ≤ 0,5 mΩ	≤ 0,5 mΩ
Operating temperature range	TU -30 - +100 °C	-30 - +100 °C
Degree of protection (IEC EN 60529)	IP 67	IP 67
Plug connector	N (m/f)	N (f/f)

#### Accessories

	MW-AntPro
Article-No.	17 01 66

Mounting plate for AntPro





### AntPro 6GHz-N

The devices are medium sized, precision, weatherproof connectors supplied with a screw coupling. Special design techniques for this series of connectors have resulted in excellent levels of performance with regard to return loss (VSWR) and intermodulation distortion.

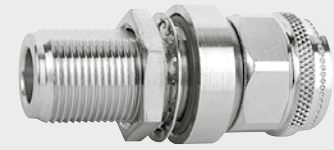

example image

- N surge suppressor male (m)-male (m) with gas discharge arrester
- N surge suppressor male (m)-female (f) with gas discharge arrester
- Recommended coupling torque: 4-6 Nm

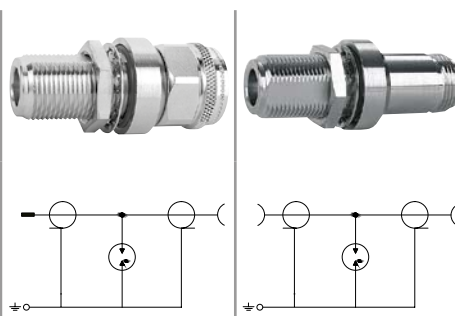
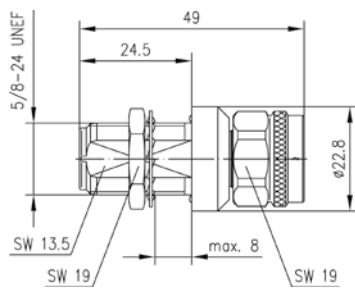

#### Technical Data

Product name	AntPro 6GHz-N(m/f)	AntPro 6GHz-N(f/f)
Article-No.	04 00 10	04 00 11
Terminal input/output	N (m/f)	N (f/f)
Nominal DC sparkover voltage at 100V/s	UagN 150-250 V=	150-250 V=
Nominal discharge current (8/20 μs)	In 5/10 kA	5/10 kA
Protection level at 1kV/μs	Up ≤ 600 V	≤ 600 V
Response time at 1kV/μs	tA < 50 ns	< 50 ns
Max. aerial capacity (permanent HF capacity at VSWR = 1.1)	Pmax 25 W	25 W
Frequency range	f0 0-6000 MHz	0-6000 MHz
Impedance	Z 50 Ω	50 Ω
Vertical resistance inner conductor	R ≤ 1.5 mΩ	≤ 1.5 mΩ
Vertical resistance outer conductor	R ≤ 1.0 mΩ	≤ 1.0 mΩ
Insulation resistance	Risol ≥ 5 GΩ	≥ 5 GΩ
Voltage resistance at 50 Hz	Umax 2.5 kVeff	2.5 kVeff
Insertion loss at 1 and 3GHz/6GHz	≤ 0.1 /0.2 dB	≤ 0.1 /0.2 dB
Return loss	RL ≥ -20 dB	≥ -20 dB
Capacitance, typ. asym. inner-conductor/earth	C ≤ 1.5 pF	≤ 1.5 pF
Operating temperature range	TU -40 - +85 °C	-40 - +85 °C
Degree of protection (IEC EN 60529)	IP 67	IP 67



# SURGE PROTECTION FOR TRANSMITTING AND RECEIVING SYSTEMS SPD WITH DIN 7/16 CONNECTOR

## DataPro Koax 7/16

DataPro Koax 7/16 was developed for the coarse protection of highly sensitive RF amplifiers with DIN 7/16 connectors such as amplifiers for GSM antenna systems.



example image

- High performance surge arrester for broadband applications with frequency ranges from DC up to 2.5 GHz.
- Applicable at the boundaries LPZ 0B - 1 and higher
- Connector according to IEC 61169-4
- Test standard: IEC 61643-21 / EN 61643-21
- Mounting with angle bracket or in mounting plate possible

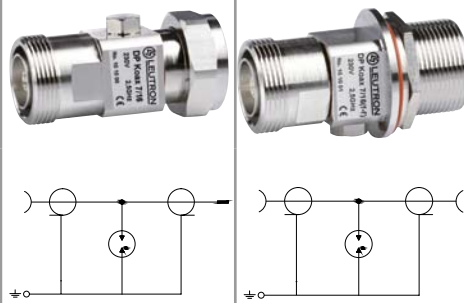
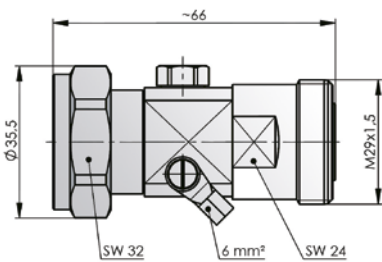

### Technical Data

Product name	DP Koax 7/16	DP Koax 7/16 (f/f)
Article-No.	10 10 00	10 10 01
IEC category	C1 / C2 / C3	C1 / C2 / C3
Surge impedance	Z 50 Ω	50 Ω
Frequency range	f0 0 - 2500 MHz	0 - 2500 MHz
Return loss	RL typ.: 1 GHz - 32 dB; 2 GHz - 23 dB; 2,2 GHz - 23 dB; 2,5 GHz - 20 dB; 2,7 GHz - 17 dB	
Insertion loss	fE typ.: 2,2 GHz <0,1 dB; 2,5 GHz <0,2 dB	typ.: 2,2 GHz <0,1 dB; 2,5 GHz <0,2 dB
DC spark-over voltage	230 V	230 V
C2 nominal discharge current (8/20 μs)	In 15 kA	15 kA
Max. impulse discharge current (8/20 μs)	Imax 20 kA	20 kA
Insulation resistance	Risol ≥ 10 GΩ	≥ 10 GΩ
Vertical resistance inner conductor	R ≤ 0,4 mΩ	≤ 0,4 mΩ
Vertical resistance outer conductor	R ≤ 0,2 mΩ	≤ 0,2 mΩ
Operating temperature range	TU -55 - +155 °C	-55 - +155 °C
Degree of protection (IEC EN 60529)	IP 67	IP 67
Plug connector	DIN 7/16 (m/f)	DIN 7/16 (f/f)



### DataPro-SAT-F

Gas-filled surge arrester (GDT) for the protection of radio and TV reception equipment. DP-SAT-F-5 ... 2500MHz should be screwed directly to each input of a multi-switch or directly to each LNB output. A gas discharge tube (GDT) works inside. If the static voltage between core and screen exceeds approximately 80 volts, a short circuit occurs in the GDT and conducts surge currents of up to 8,000 amps to earth. Once the overvoltage is over, the GDT switches back to protection.

- High performance antenna protection
- Connections: F-plug / F-socket
- Suitable for outdoor use: F connector with sealing ring
- DC pass for remote supply
- Shielding level: 100 dB (depending on frequency)
- Easy installation

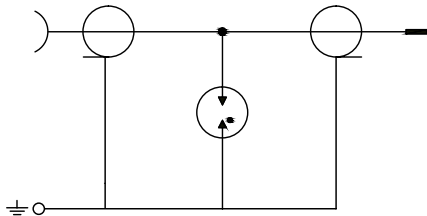

Technical Data	
<b>Product name</b>	<b>DP-SAT-F-5...2500MHz</b>
Article-No.	21 00 10
IEC category	D1 / C2
Nominal voltage DC	UN 60 V=
Max. permissible rated direct voltage	Uc 75 V=
Nominal current	IL 0,5 A
D1 lightning impulse current (10/350 µs)	Iimp 2,5 kA
C2 Nominal impulse discharge current (8/20 µs)	I <sub>max</sub> 8 kA
Protection level at Iimp (10/350 µs)	Up ≤ 0,6 kV
Protection level at In (8/20 µs)	Up ≤ 0,6 kV
Max. impulse sparkover voltage	U <sub>as</sub> 90 ±20% V
Impulse sparkover voltage core-shield (1 kV/µs)	U <sub>as</sub> ≤ 600 V
Surge impedance	Z 75 Ω
Insertion loss	fE < 0,3 dB
Frequency range	f0 5...2500 MHz
Insulation resistance	Risol 10 GΩ
Response time	tA ≤ 100 ns
Operating temperature range	TU -40 - +80 °C
Type of connection	F75/F75 (Socket / plug)
Locking torque	0,6 Nm
Enclosure material	Nickel-plated brass
Dimension (Ø x L)	14 x 40 mm



Accessories for DataPro SAT-F	
	DP-SAT-EB5
Article-No.	17 01 80



Earthing (grounding) block for five pieces DP-SAT-F-5 ... 2500MHz. Solid, stable 5 F grounding block for the proper grounding of antenna systems. Excellent electrical properties ensure almost loss-free transmission and minimal reflections. Large assembly-friendly distance from socket to socket.

- Connections 2 x 5 F sockets
- 4 x earthing connections up to 10 mm<sup>2</sup>

## FILTER WITH INTEGRATED SURGE PROTECTION

For protection against overvoltages and harmonics Leutron offers EMC filters which are combined with a surge protection. These devices suppress harmonics and transient surges, hence, allowing equipment to operate smoothly even in high-interference environments. With the enhancement of its product range Leutron now offers protective devices for the area of measuring systems and automatic control, thus covering the complete field of industrial applications.

**Leutron guarantees reliable signals due to EMC filters.**

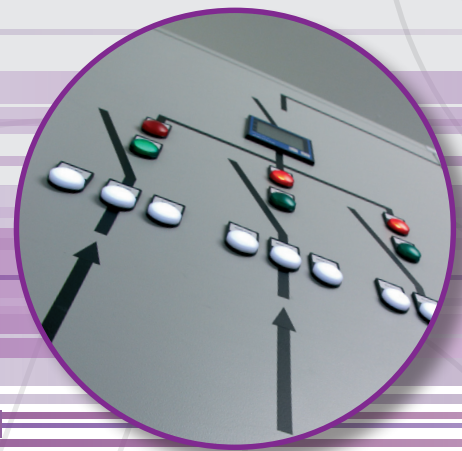
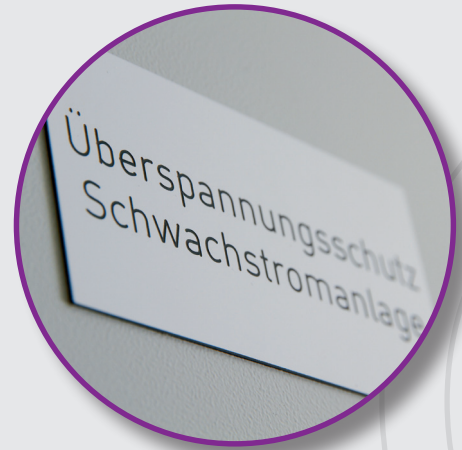

## EMC FILTERS COMBINED WITH HARMONIZED SURGE PROTECTION:

- Protection against transient overvoltages and harmonics
- Leakage-current free
- Low residual voltages mean reduced stress for the system to be protected
- Outstanding differential-mode and common-mode damping of the filters

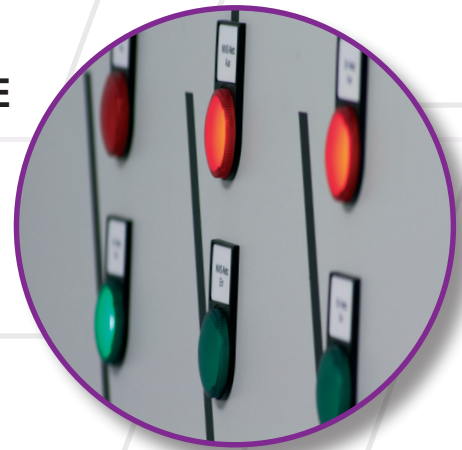



The EMC filters convince with their compact construction and the optimally harmonised protection components filter and surge protection.

## EMC FILTERS WITH INTEGRATED SURGE PROTECTION

# FILTERS WITH INTEGRATED SURGE PROTECTION UP TO 200 A



Robust and shielded design

Versions up to a nominal current of 200 A available

For one phase and three phase mains supplies

Harmonics filter, combined with surge protection

EAC Certification





## FILTERS WITH INTEGRATED SURGE PROTECTION FOR MEASURING AND CONTROL EQUIPMENT

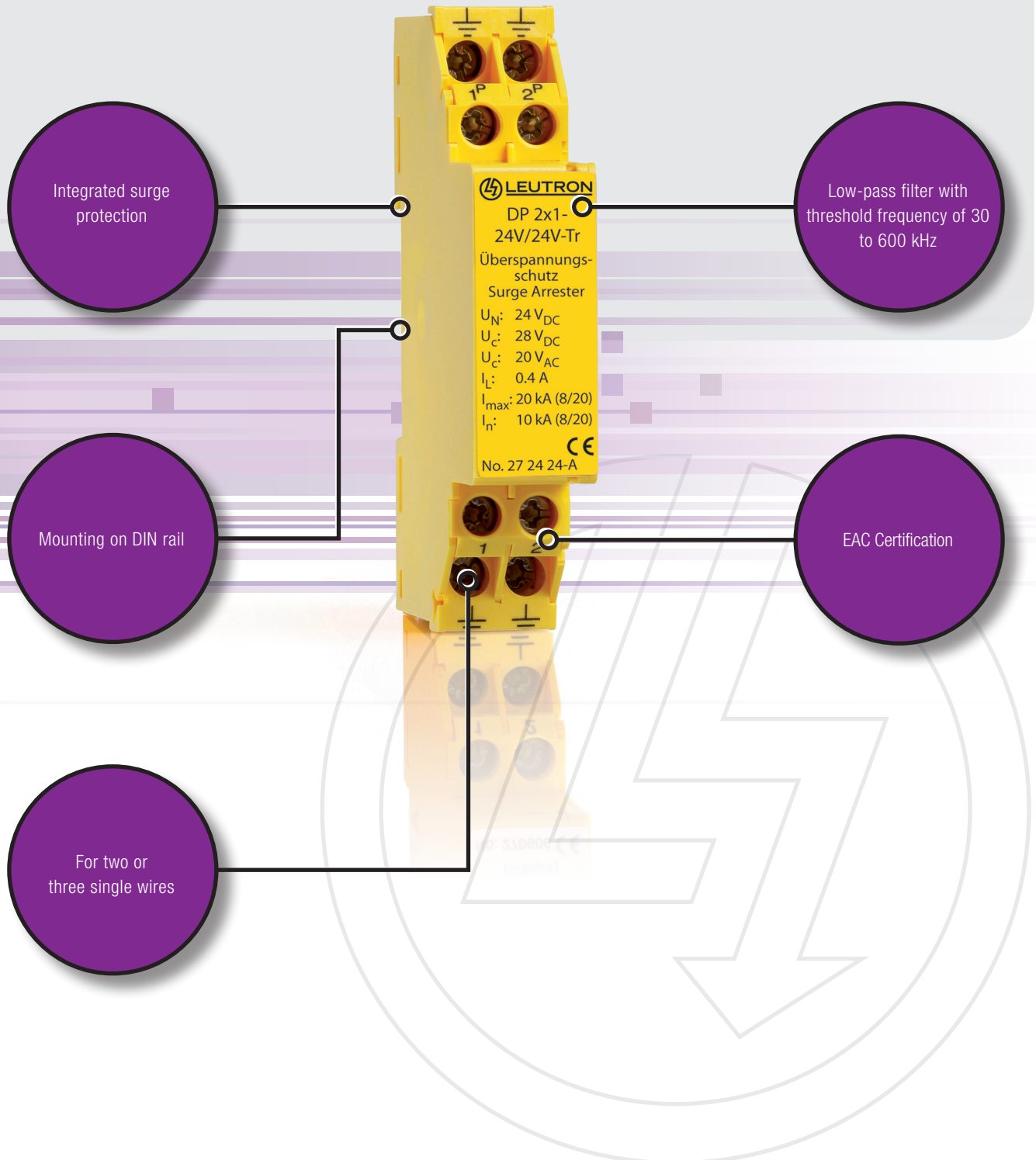



# EMC FILTER WITH INTEGRATED SURGE PROTECTION

## TABLE OF CONTENTS

EMC filter with integrated surge protection		Page
<b>Line filter up to 200A</b>		<b>177</b>
EnerPro Filter for mounting rail	EMV-Filter for 35 mm Din rail mounting (EN 60715), SPD Type 2+3	177
EnerPro Filter up to 35 A, two-pole	EMV-Filter for mounting plate, SPD Type 2+3	178
EnerPro Filter up to 35 A, four-pole	EMV-Filter for mounting plate, SPD Type 2+3	180
EnerPro Filter up to 200A, four-pole	EMV-Filter for mounting plate, SPD Type 2+3	181
<b>MCR technology with integrated low-pass filter</b>		<b>182</b>
IsoProData 150V/150V-Tr	IEC category: D1/C2/C1/C3, Nominal voltage DC 150 Volt	182
DataPro 2x1 for DIN rail mounting	IEC category: D1/C2/C1/C3, Nominal voltage DC (6 up to 150 Volt)	183
DataPro 3x1 for DIN rail mounting	IEC category: D1/C2/C1/C3, Nominal voltage DC (6 up to 150 Volt)	185
DataPro 2x1 0,30hm-Tr	IEC category: D1/C2/C1/C3, Nominal voltage DC (12 up to 60 Volt)	187
DataPro 2x1-RLC/50V-Tr	IEC category: D1/C2/C1/C3, Protection of DC measuring lines up to 50 Volt	189
DataPro 2x1-RLC-Tr	IEC category: D1/C2/C1/C3, Nominal voltage DC 150 Volt	189
DataPro 2-2MB-Tr	IEC category: C2/C1/C3, Transmission $\leq$ 2 Mbits/s (ISDN, PCM)	190
DataPro 2x8-36V/36V-Tr/GO	Two-stage low-pass filter with eight lines	191
DataPro Z	Compact protective circuit on single printed circuit board	192

## EnerPro Filter for mounting rail

EMC filters with integrated overvoltage protection enable smooth operation of highly sensitive electronics in harsh environments.

Suitable for the application in single-phase TN systems. The protective circuit with filter contains an optimal decoupling between its medium protection (varistors) and its fine protection (varistors).



example image

- Applicable at the boundaries LPZ 0B - 2 and higher
- All leakage current-afflicted elements are galvanically isolated from earth by a gas-filled surge arrester (GDT)
- Test standard: IEC 61643-11 / EN 61643-11
- Remote signalling contact (FM): break contact
- EAC Certification

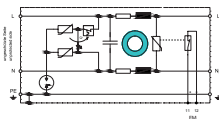
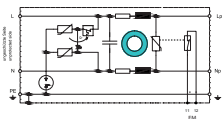
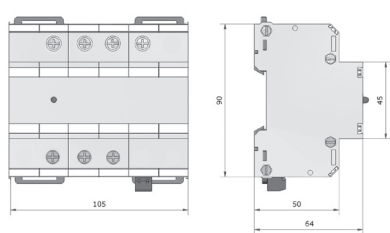

### Technical Data

Product name	EPF 230V/16A-Tr2-FM	EPF 230V/25A-Tr2-FM
Article-No.	25 30 09	25 30 11
IEC category	Type 2 + 3 / class II + III	Type 2 + 3 / class II + III
Nominal voltage AC	UN 230 V~	230 V~
Max. continuous operating voltage AC (50/60Hz)	Uc 275 V~	275 V~
Protection level at 5 kA (8/20 μs)	Up ≤ 1,4 kV	≤ 1,4 kV
Protection level at In (8/20 μs)	Up ≤ 2 kV	≤ 2 kV
Response time L-N/L,N-PE	≤ 25 ns	≤ 25 ns
Nominal discharge current (10 x 8/20 μs)	In 15 kA	15 kA
Max. impulse discharge current (1x 8/20 μs)	Imax 25 kA	25 kA
Max. allowed fuse or back-up fuse	16 A gG	25 A gG
Operating temperature range	TU -40 - +80 °C	-40 - +80 °C
Max. conductor cross section	50mm <sup>2</sup> stranded/35mm <sup>2</sup> flexible	50mm <sup>2</sup> stranded/35mm <sup>2</sup> flexible
Recommended conductor cross section	25 mm <sup>2</sup>	25 mm <sup>2</sup>
Max. connection torque for terminals	4,0 Nm	4,0 Nm
Enclosure material / colour	Polycarbonate UL 94-V0 / yellow	Polycarbonate UL 94-V0 / yellow
Degree of protection (IEC EN 60529)	IP 20	IP 20
Mounting on	35 mm DIN rail (EN 60715)	35 mm DIN rail (EN 60715)
Installation dimensions (H x W x D)	105 x 90 x 64 mm	105 x 90 x 64 mm



# EMC FILTER WITH INTEGRATED SURGE PROTECTION LINE FILTER UP TO 200A

## EnerPro Filter up to 35A, 2 pole

EMC filters with integrated overvoltage protection enable smooth operation of highly sensitive electronics in harsh environments. Suitable for the application in single-phase TN systems. The low-pass filter eliminates high-frequency electromagnetic interferences caused by lightning or switching actions in the network.



example image

- Applicable at the boundaries LPZ 0B - 2 and higher
- Test standard: IEC 61643-11 / EN 61643-11
- Maximum impulse discharge current of 20 kA (8/20  $\mu$ s)
- Mounting on plate
- EAC Certification

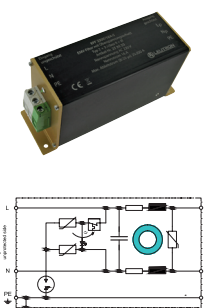
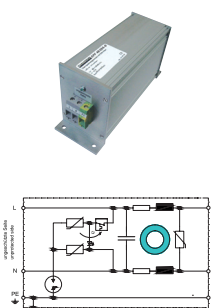
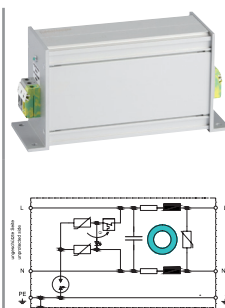
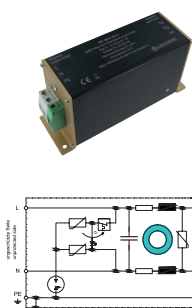
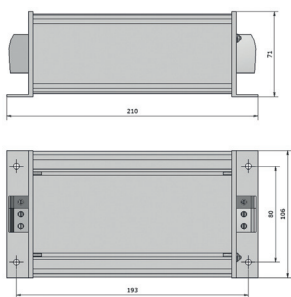

### Technical Data

Product name	EPF 48V/16A-S	EPF 60V/16A-S	EPF 48V/25A-S	EPF 230V/16A-S
Article-No.	25 30 19	25 30 22	25 30 53	25 30 20
IEC category	Type 2 + 3 / class II + III	Type 2 + 3 / class II + III	Type 2 + 3 / class II + III	Type 2 + 3 / class II + III
Nominal voltage DC	UN 48 V=	60 V=	48 V=	-
Nominal voltage AC	UN 42 V~	42 V~	42 V~	230 V~
Max. continuous operating voltage DC	Uc 70 V=	70 V=	70 V=	-
Max. continuous operating voltage AC (50/60Hz)	Uc 50 V~	50 V~	50 V~	275 V~
Protection level (1kV/ $\mu$ s)	Up $\leq 1,5$ kV	$\leq 1,5$ kV	$\leq 1,0$ kV	$\leq 1,4$ kV
Protection level at In (8/20 $\mu$ s); worst case	Up $\leq 2,5$ kV	$\leq 2,5$ kV	$\leq 1,5$ kV	$\leq 2$ kV
Response time L-N/L,N-PE	$\leq 25$ ns	$\leq 25$ ns	$\leq 25$ ns	$\leq 25$ ns
Nominal discharge current (8/20 $\mu$ s)	In 15 kA	15 kA	15 kA	15 kA
Max. impulse discharge current (8/20 $\mu$ s)	Imax 20 kA	20 kA	20 kA	20 kA
Max. allowed fuse or back-up fuse	16 A gG	16 A gG	25 A gG	16 A gG
Operating temperature range	TU -40 - +80 °C	-40 - +80 °C	-40 - +80 °C	40 - +80 °C
Max. conductor cross section	4 mm <sup>2</sup>	4 mm <sup>2</sup>	4 mm <sup>2</sup>	single wire 10 mm <sup>2</sup> / flexible 6 mm <sup>2</sup>
Recommended conductor cross section	2,5 mm <sup>2</sup>	2,5 mm <sup>2</sup>	2,5 mm <sup>2</sup>	2,5 mm <sup>2</sup>
Enclosure material / colour	Aluminum / black-gold	aluminium / silver	aluminium / silver	Aluminum / black-gold
Dimensions (L x W x H)	215,6 x 109,5 x 69,5 mm	211 x 71 x 106 mm	211 x 71 x 106 mm	215,6 x 109,5 x 69,5 mm
Degree of protection (IEC EN 60529)	IP 20	IP 20	IP 20	IP 20

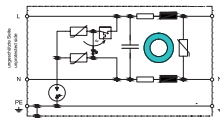
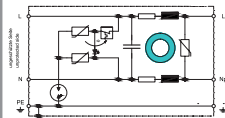
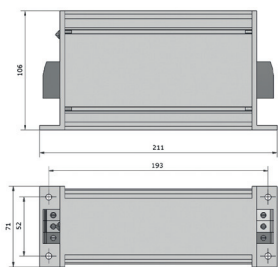

## Technical Data

Product name	EPF 230V/16A-W	EPF 230V/35A-S
Article-No.	25 30 25	25 30 85
IEC category	Type 2 + 3 / class II + III	Type 2 + 3 / class II + III
Nominal voltage DC	UN	-
Nominal voltage AC	UN 230 / 400 V~	230 V~
Max. continuous operating voltage DC	Uc	-
Max. continuous operating voltage AC (50/60Hz)	Uc 275 / 480 V~	275 V~
Protection level (1kV/μs)	Up ≤ 1,4 kV	≤ 1,4 kV
Protection level at In (8/20 μs); worst case	Up ≤ 2 kV	≤ 2 kV
Response time L-N/L,N-PE	≤ 25 ns	≤ 25 ns
Nominal discharge current (8/20 μs)	In 15 kA	15 kA
Max. impulse discharge current (8/20 μs)	I <sub>max</sub> 20 kA	20 kA
Max. allowed fuse or back-up fuse	16 A gG	35 A gG
Max. conductor cross section		
Operating temperature range	TU -40 - +80 °C	-40 - +80 °C
Enclosure material / colour	aluminium / silver	aluminium / silver
Dimensions (L x W x H)	211 x 106 x 72 mm	211 x 71 x 106 mm
Degree of protection (IEC EN 60529)	IP 20	IP 20
Mounting on	Mounting plate	Mounting plate



# EMC FILTER WITH INTEGRATED SURGE PROTECTION LINE FILTER UP TO 200A

## EnerPro Filter up to 35 A, four-pole

EMC filters with integrated overvoltage protection enable smooth operation of highly sensitive electronics in harsh environments. Suitable for the application in three-phase 230/400V TN systems.



example image

- Applicable at the boundaries LPZ 0B - 2 and higher
- Leakage current-free
- Test standard: IEC 61643-11 / EN 61643-11
- Protects foundation earthing electrode against AC-caused corrosion
- To protect the supply of sensible equipment and installations
- Maximum impulse discharge current of 20 kA (8/20  $\mu$ s)
- EAC Certification

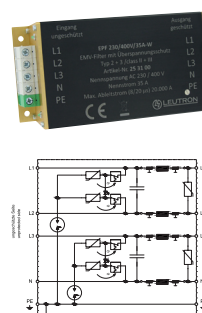
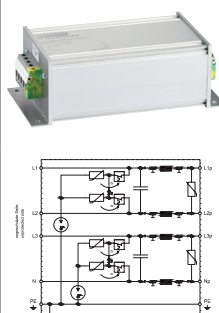
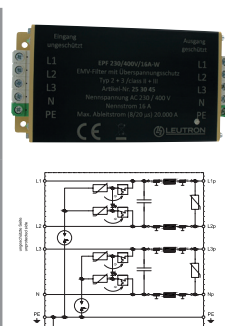
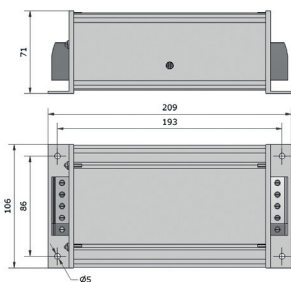

### Technical Data

Product name	EPF 230/400V/16A-W	EPF 230/400V/25A-W	EPF 230/400V/35A-W
Article-No.	25 30 45	25 30 80	25 31 00
IEC category	Type 2 + 3 / class II + III	Type 2 + 3 / class II + III	Type 2 + 3 / class II + III
Nominal voltage AC	UN 230 / 400 V~	230 / 400 V~	230 / 400 V~
Max. continuous operating voltage AC (50/60Hz)	Uc 275 / 480 V~	480 V~	275 / 480 V~
Protection level at 5kA (8/20 $\mu$ s) oder 1kV/ $\mu$ s	Up $\leq 1,4$ kV	$\leq 1,4$ kV	$\leq 1,4$ kV
Protection level at In (8/20 $\mu$ s); worst case	Up $\leq 2$ kV	$\leq 2$ kV	$\leq 2$ kV
Nominal current	IL 16 A	25 A	35 A
Response time	tA $\leq 25$ ns	$\leq 25$ ns	$\leq 25$ ns
Nominal discharge current (8/20 $\mu$ s)	In 15 kA	15 kA	15 kA
Max. impulse discharge current (8/20 $\mu$ s)	Imax 20 kA	25 kA	20 kA
Max. allowed fuse or back-up fuse	16 A gG	25 A gG	35 A gG
Operating temperature range	TU -40 - +80 °C	-40 - +80 °C	-40 - +80 °C
Max. conductor cross section	single wire 10mm <sup>2</sup> / flexible 6mm <sup>2</sup>		
Dimensions (L x W x H)	216 x 105 x 71 mm	211 x 106 x 72 mm	216 x 105 x 71 mm
Enclosure material / colour	Aluminum / black-gold	aluminium / silver	Aluminum / black-gold
Degree of protection (IEC EN 60529)	IP 20	IP 20	IP 20
Mounting on	Mounting plate	Mounting plate	Mounting plate

## EnerPro Filter up to 200A, four-pole

EMC filters with integrated overvoltage protection enable smooth operation of highly sensitive electronics in harsh environments.

Suitable for the application in three-phase 230/400V TN systems.



example image

- Applicable at the boundaries LPZ 0B - 2 and higher
- 4-pole, for 3 phases und N (L1 / L2 / L3 / N-PE)
- Leakage current-free
- Test standard: IEC 61643-11 / EN 61643-11
- Protects foundation earthing electrode against AC-caused corrosion
- To protect the supply of sensible equipment and installations
- EAC Certification

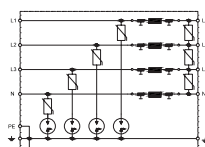
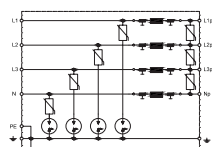
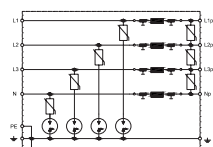
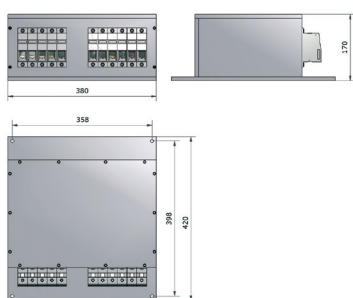

### Technical Data

Product name	EPF 230/400V/63A-E	EPF 230/400V/100A-E	EPF 230/400V/200A-E
Article-No.	25 31 30	25 31 40	25 31 60
IEC category	Type 2 + 3 / class II + III	Type 2 + 3 / class II + III	Type 2 + 3 / class II + III
Nominal voltage AC	UN 230 / 400 V~	230 / 400 V~	230 / 400 V~
Max. continuous operating voltage AC (50/60Hz)	Uc 275 / 480 V~	275 / 480 V~	275 / 480 V~
Protection level at 5kA (8/20 μs) or 1kV/μs	Up ≤ 1,4 kV	≤ 1,4 kV	≤ 1,4 kV
Protection level at In (8/20 μs); worst case	Up ≤ 2 kV	≤ 2 kV	≤ 2 kV
Response time	tA ≤ 25 ns	≤ 25 ns	≤ 25 ns
Nominal discharge current (8/20 μs)	In 15 kA	15 kA	15 kA
Max. impulse discharge current (8/20 μs)	Imax 25 kA	25 kA	25 kA
Max. allowed fuse or back-up fuse	63 A gG	100 A gG	200 A gG
Operating temperature range	TU -40 - +80 °C	-40 - +80 °C	-40 - +80 °C
Max. conductor cross section	solid 25-95/flexible. 35-95 mm <sup>2</sup>	solid 25-95/flexible. 35-95 mm <sup>2</sup>	solid 25-95/flexible. 35-95 mm <sup>2</sup>
Max. connection torque for terminals	4,5 Nm	4,5 Nm	4,5 Nm
Dimensions (L x W x H)	420 x 358 x 170 mm	420 x 380 x 170 mm	420 x 380 x 170 mm
Enclosure material / colour	aluminium / silver	aluminium / silver	aluminium / silver
Degree of protection (IEC EN 60529)	IP 20	IP 20	IP 20
Mounting on	Mounting plate	Mounting plate	Mounting plate
Capacity at 250V/200A	2x 0,5 μF	2x 0,5 μF	2x 0,5 μF



### IsoProData 150V/150V-Tr

EMC filter for data and signal lines combined with surge protection enables smooth operation of sensitive electronic equipment in rough environment.

- Signal and data line protection with low-pass filter
- Protective circuit for 2 signal lines without reference to ground potential
- Applicable at the boundaries LPZ 0A - 2 and higher
- Mounting on 35 mm DIN rail (EN 60715)
- Degree of protection nach IEC EN 60529: IP 20
- Space required for installation: 17.5 mm
- Inflammability class according to UL 94 V0
- EAC Certification

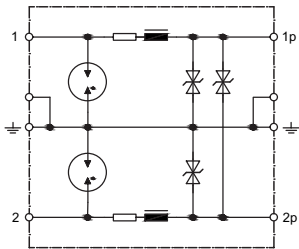

Technical Data		IsoProData 150V/150V-Tr
<b>Product name</b>	IsoProData 150V/150V-Tr	
Article-No.	27 03 03	
IEC category	D1 / C2 / C1 / C3	
Nominal voltage DC	UN	150 V=
Max. continuous operating voltage DC	Uc	160 V=
Max. continuous operating voltage AC (50/60Hz)	Uc	112 V~
Nominal current	IL	1,5 A
Leakage current at Uc DC	≤ 5 µA	
Longitudinal impedance (DC resistance) per wire	Z	0,3 Ω
Series inductance, typ.	L	130 µH
Insulation resistance	Risol	> 10 GΩ
Response time	tA	≤ 2 ns
C2 Nominal discharge current (8/20 µs)	In	20 kA
D1 lightning impulse current (10/350 µs) total	Itotal	10 kA
D1 lightning impulse current (10/350 µs) per line	limp	5 kA
Protection level, residual voltage line-ground at In resp. 1 kV/µs	Up	≤ 250 V
Capacitance, line-earth	C	< 1 nF
Max. operating frequency (-3 dB)	fG	600 kHz
Operating temperature range	TU	-25 - +85 °C

#### Accessories DataPro and EnerPro

Article-No.	Grounding bridge
	17 00 80

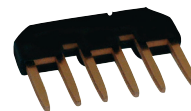

Bridge for optimal grounding. The cross section is 1,5 mm<sup>2</sup> per pin. The upper surface of the Grounding bridge is inslotated with plastics.





## DataPro 2x1 for DIN rail mounting

EMC filter for data and signal lines combined with surge protection enables smooth operation of sensitive electronic equipment in rough environment.



example image

- Signal and data line protection with low-pass filter
- Protective circuit for 2 signal lines with common ground
- Applicable at the boundaries LPZ 0A - 2 and higher
- Mounting on 35 mm DIN rail (EN 60715)
- Degree of protection nach IEC EN 60529: IP 20
- Space required for installation: 17.5 mm
- Inflammability class according to UL 94 V0
- Max. conductor cross section: 2.5 mm<sup>2</sup> solid or 1.5 mm<sup>2</sup> flexible with sleeve
- Max. connection torque for terminals: 1,5 Nm
- EAC Certification

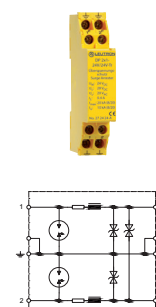
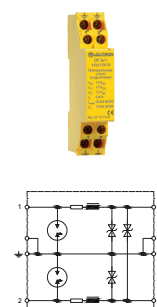
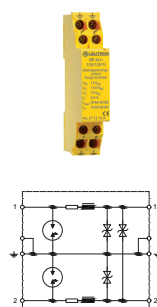
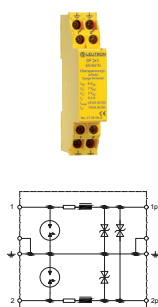
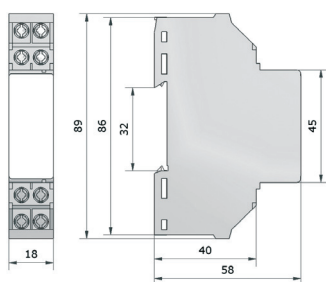

### Technical Data

Product name	DP 2x1-6V/6V-Tr	DP 2x1-12V/12V-Tr	DP 2x1-15V/15V-Tr	DP 2x1-24V/24V-Tr
Article-No.	27 06 06-A	27 12 12-A	27 15 15-A	27 24 24-A
IEC category	D1 / C2 / C1 / C3	D1 / C2 / C1 / C3	D1 / C2 / C1 / C3	D1 / C2 / C1 / C3
Nominal voltage DC	UN 6 V=	12 V=	15 V=	24 V=
Max. continuous operating voltage DC	Uc 7 V=	13,6 V=	17 V=	28 V=
Max. continuous operating voltage AC (50/60Hz)	Uc 5 V~	10 V~	12 V~	20 V~
Nominal current	IL 0,4 A	0,4 A	0,4 A	0,4 A
C2 Nominal discharge current (8/20 μs)	In 10 kA	10 kA	10 kA	10 kA
C2 Nominal discharge current (8/20 μs) total	Imax 20 kA	20 kA	20 kA	20 kA
D1 lightning impulse current (10/350 μs)	Iimp 2,5 kA	2,5 kA	2,5 kA	2,5 kA
D1 lightning impulse current (10/350 μs) total	Itotal 5 kA	5 kA	5 kA	5 kA
Protection level at In (line-earth)	Up ≤ 9 V	≤ 18 V	≤ 23 V	≤ 36 V
Leakage current at Uc	≤ 5 μA	≤ 5 μA	≤ 5 μA	≤ 5 μA
Max. operating frequency (-3 dB)	fG 600 kHz	600 kHz	600 kHz	600 kHz
DC resistance	R 3,2 Ω	3,2 Ω	3,2 Ω	3,2 Ω
Series inductance, typ.	L 30 μH	30 μH	30 μH	30 μH
Response time	tA ≤ 2 ns	≤ 2 ns	≤ 2 ns	≤ 2 ns
Capacitance, line-earth	C 4 nF	<2,3 nF	≤ 1,5 nF	≤ 1,3 nF
Operating temperature range	TU -25 - +85 °C	-25 - +85 °C	-25 - +85 °C	-25 - +85 °C

### Accessories DataPro and EnerPro

	Grounding bridge
Article-No.	17 00 80

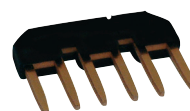

Bridge for optimal grounding. The cross section is 1,5 mm<sup>2</sup> per pin. The upper surface of the Grounding bridge is inslotated with plastics.



# EMC FILTER WITH INTEGRATED SURGE PROTECTION

## MCR TECHNOLOGY WITH INTEGRATED LOW-PASS FILTER

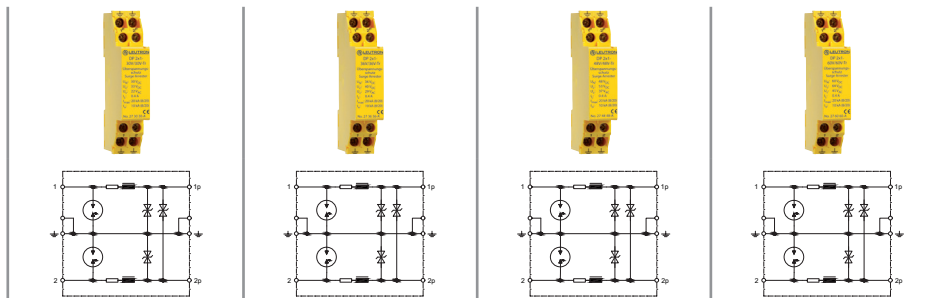

### Technical Data

Product name	DP 2x1-30V/30V-Tr	DP 2x1-36V/36V-Tr	DP 2x1-48V/48V-Tr	DP 2x1-60V/60V-Tr
Article-No.	27 30 30-A	27 36 36-A	27 48 48-A	27 60 60-A
IEC category	D1 / C2 / C1 / C3	D1 / C2 / C1 / C3	D1 / C2 / C1 / C3	D1 / C2 / C1 / C3
Nominal voltage DC	UN 30 V=	36 V=	48 V=	60 V=
Max. continuous operating voltage DC	Uc 33 V=	40 V=	53 V=	64 V=
Max. continuous operating voltage AC (50/60Hz)	Uc 22 V~	29 V~	37 V~	45 V~
Nominal current	IL 0,4 A	0,4 A	0,4 A	0,4 A
C2 Nominal discharge current (8/20 μs)	In 10 kA	10 kA	10 kA	10 kA
C2 Nominal discharge current (8/20 μs) total	Imax 20 kA	20 kA	20 kA	20 kA
D1 lightning impulse current (10/350 μs)	Iimp 2,5 kA	2,5 kA	2,5 kA	2,5 kA
D1 lightning impulse current (10/350 μs) total	Itotal 5 kA	5 kA	5 kA	5 kA
Protection level at In (line-earth)	Up ≤ 45 V	≤ 55 V	≤ 72 V	≤ 90 V
Leakage current at Uc	≤ 5 μA	≤ 5 μA	≤ 5 μA	≤ 5 μA
Max. operating frequency (-3 dB)	fG 600 kHz	600 kHz	600 kHz	600 kHz
DC resistance	R 3,2 Ω	3,2 Ω	3,2 Ω	3,2 Ω
Series inductance, typ.	L 30 μH	30 μH	30 μH	30 μH
Response time	tA ≤ 2 ns	≤ 2 ns	≤ 2 ns	≤ 2 ns
Capacitance, line-earth	C ≤ 1 nF	≤ 1 nF	≤ 0,8 nF	≤ 0,7 nF
Operating temperature range	TU -25 - +85 °C	-25 - +85 °C	-25 - +85 °C	-25 - +85 °C

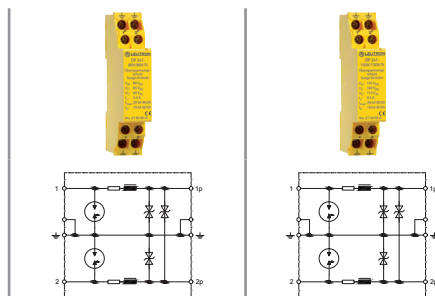

### Technical Data

Product name	DP 2x1-80V/80V-Tr	DP 2x1-150V/150V-Tr
Article-No.	27 80 80-A	27 04 04-A
IEC category	D1 / C2 / C1 / C3	D1 / C2 / C1 / C3
Nominal voltage DC	UN 80 V=	150 V=
Max. continuous operating voltage DC	Uc 85 V=	160 V=
Max. continuous operating voltage AC (50/60Hz)	Uc 60 V~	112 V~
Nominal current	IL 0,4 A	0,4 A
C2 Nominal discharge current (8/20 μs)	In 10 kA	10 kA
C2 Nominal discharge current (8/20 μs) total	Imax 20 kA	20 kA
D1 lightning impulse current (10/350 μs)	Iimp 2,5 kA	2,5 kA
D1 lightning impulse current (10/350 μs) total	Itotal 5 kA	5 kA
Protection level at In (line-earth)	Up ≤ 140 V	≤ 250 V
Leakage current at Uc DC	≤ 5 μA	≤ 5 μA
Max. operating frequency (-3 dB)	fG 600 kHz	600 kHz
DC resistance	R 3,2 Ω	3,2 Ω
Series inductance, typ.	L 30 μH	30 μH
Capacitance, line-earth	C ≤ 1 nF	≤ 1 nF
Operating temperature range	TU -25 - +85 °C	-25 - +85 °C

## DataPro 3x1 for DIN rail mounting

EMC filter for data and signal lines combined with surge protection enables smooth operation of sensitive electronic equipment in rough environment.

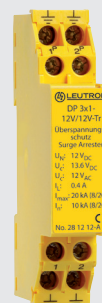

example image

- Signal and data line protection with low-pass filter
- Protective circuit for 3 signal lines with common ground
- Applicable at the boundaries LPZ 0A - 2 and higher
- Mounting on 35 mm DIN rail (EN 60715)
- Degree of protection nach IEC EN 60529: IP 20
- Space required for installation: 17.5 mm
- Inflammability class according to UL 94 V0
- Max. conductor cross section: 2.5mm<sup>2</sup> solid or 1.5mm<sup>2</sup> flexible with sleeve
- Max. connection torque for terminals: 1,5 Nm
- EAC Certification

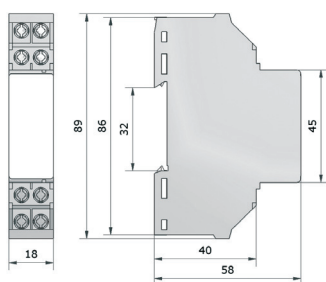

### Technical Data

Product name	DP 3x1-12V/12V-Tr	DP 3x1-15V/15V-Tr	DP 3x1-24V/24V-Tr	DP 3x1-30V/30V-Tr
Article-No.	28 12 12-A	28 15 15-A	28 24 24-A	28 30 30-A
IEC category	D1 / C2 / C1 / C3	D1 / C2 / C1 / C3	D1 / C2 / C1 / C3	D1 / C2 / C1 / C3
Nominal voltage DC	UN 12 V=	15 V=	24 V=	30 V=
Max. continuous operating voltage DC	Uc 13,6 V=	17 V=	28 V=	33 V=
Max. continuous operating voltage AC (50/60Hz)	Uc 12 V~	12 V~	20 V~	22 V~
Nominal current	IL 0,4 A	0,4 A	0,4 A	0,4 A
C2 Nominal discharge current (8/20 μs)	In 10 kA	10 kA	10 kA	10 kA
C2 Nominal discharge current (8/20 μs) total	Imax 20 kA	20 kA	20 kA	20 kA
D1 lightning impulse current (10/350 μs)	Iimp 2,5 kA	2,5 kA	2,5 kA	2,5 kA
D1 lightning impulse current (10/350 μs) total	Itotal 7,5 kA	7,5 kA	7,5 kA	7,5 kA
Protection level at In (line-earth)	Up ≤ 18 V	≤ 23 V	≤ 36 V	≤ 45 V
Leckstrom bei Umax DC	≤ 5 μA	≤ 5 μA	≤ 5 μA	≤ 5 μA
Max. operating frequency (-3 dB)	fG 600 kHz	600 kHz	600 kHz	600 kHz
DC resistance	R 3,2 Ω	3,2 Ω	3,2 Ω	3,2 Ω
Series inductance, typ.	L 30 μH	30 μH	30 μH	30 μH
Capacitance, line-earth	C ≤ 2,3 nF	≤ 1,5 nF	≤ 1,3 nF	≤ 1 nF
Operating temperature range	TU -25 - +85 °C	-25 - +85 °C	-25 - +85 °C	-25 - +85 °C
Enclosure material / colour	Polycarbonate UL 94-V0 / yellow	Polycarbonate UL 94-V0 / yellow	Polycarbonate UL 94-V0 / yellow	Polycarbonate UL 94-V0 / yellow



# EMC FILTER WITH INTEGRATED SURGE PROTECTION

## MCR TECHNOLOGY WITH INTEGRATED LOW-PASS FILTER

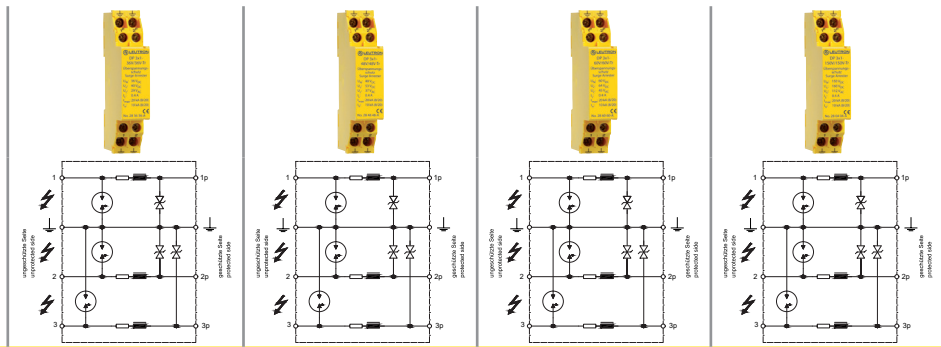

### Technical Data

Product name	DP 3x1-36V/36V-Tr	DP 3x1-48V/48V-Tr	DP 3x1-60V/60V-Tr	DP 3x1-150V/150V-Tr
Article-No.	28 36 36-A	28 48 48-A	28 60 60-A	28 04 04-A
IEC category	D1 / C2 / C1 / C3	D1 / C2 / C1 / C3	D1 / C2 / C1 / C3	D1 / C2 / C1 / C3
Nominal voltage DC	UN 36 V=	48 V=	60 V=	150 V=
Max. continuous operating voltage DC	Uc 40 V=	53 V=	64 V=	160 V=
Max. continuous operating voltage AC (50/60Hz)	Uc 29 V~	37 V~	45 V~	112 V~
Nominal current	IL 0,4 A	0,4 A	0,4 A	0,4 A
C2 Nominal discharge current (8/20 µs)	In 10 kA	10 kA	10 kA	10 kA
C2 Nominal discharge current (8/20 µs) total	Imax 20 kA	20 kA	20 kA	20 kA
D1 lightning impulse current (10/350 µs)	Iimp 2,5 kA	2,5 kA	2,5 kA	2,5 kA
D1 lightning impulse current (10/350 µs) total	Itotal 7,5 kA	7,5 kA	7,5 kA	7,5 kA
Protection level at In (line-earth)	Up ≤ 55 V	≤ 72 V	≤ 90 V	≤ 250 V
Leckstrom bei Umax DC	≤ 5 µA	≤ 5 µA	≤ 5 µA	≤ 5 µA
Max. operating frequency (-3 dB)	fG 600 kHz	600 kHz	600 kHz	600 kHz
DC resistance	R 3,2 Ω	3,2 Ω	3,2 Ω	3,2 Ω
Series inductance, typ.	L 30 µH	30 µH	30 µH	30 µH
Capacitance, line-earth	C ≤ 1 nF	≤ 0,8 nF	≤ 0,7 nF	≤ 1 nF
Operating temperature range	TU -25 - +85 °C	-25 - +85 °C	-25 - +85 °C	-25 - +85 °C
Enclosure material / colour	Polycarbonate UL 94-V0 / yellow	Polycarbonate UL 94-V0 / yellow	Polycarbonate UL 94-V0 / yellow	Polycarbonate UL 94-V0 / yellow

### Accessories DataPro and EnerPro

	Grounding bridge
Article-No.	17 00 80

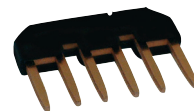

Bridge for optimal grounding. The cross section is 1,5 mm<sup>2</sup> per pin. The upper surface of the Grounding bridge is inslotated with plastics.

## DataPro 2x1 0,30hm-Tr

EMC filter for data and signal lines combined with surge protection enables smooth operation of sensitive electronic equipment in rough environment. Lightning current and surge voltage protection for particularly long signal and bus lines. Thanks to the extremely low volume resistance (impedance only 0.3 Ω) no noteworthy signal losses occur. It is a combined arrester to protect two single wires.

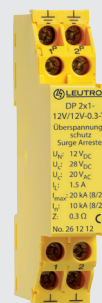

example image

- Signal and data line protection with low-pass filter
- Very low volume resistance of 0,3 Ohm
- Protective circuit for 2 signal lines with common ground
- Applicable at the LPZ transition point OA - 2 and higher
- Mounting on 35 mm DIN rail (EN 60715)
- Degree of protection nach IEC EN 60529: IP 20
- Space required for installation: 17.5 mm
- Inflammability class according to UL 94 V0
- EAC Certification

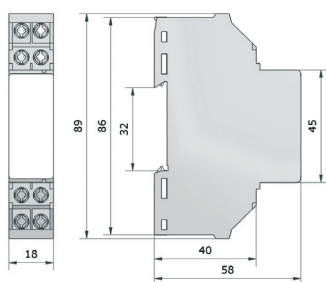

Technical Data

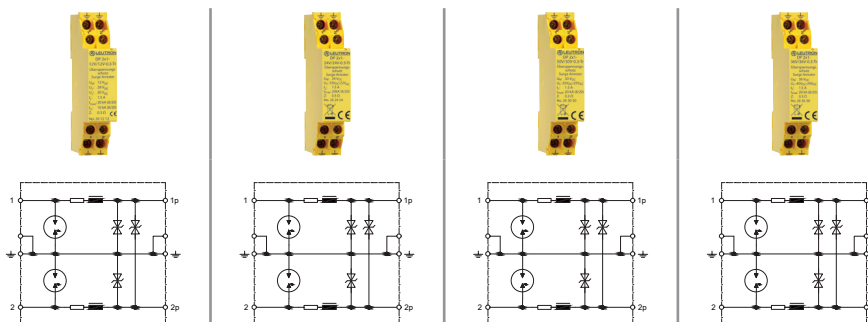

Product name	DP 2x1-12V/12V-0.3Ω-Tr	DP 2x1-24V/24V-0.3Ω-Tr	DP 2x1-30V/30V-0.3Ω-Tr	DP 2x1-36V/36V-0.3Ω-Tr
Article-No.	26 12 12	26 24 24	26 30 30	26 36 36
IEC category	D1 / C2 / C1 / C3	D1 / C2 / C1 / C3	D1 / C2 / C1 / C3	D1 / C2 / C1 / C3
Nominal voltage DC	UN 12 V=	24 V=	30 V=	36 V=
Max. continuous operating voltage DC	Uc 28 V=	33 V=	35 V=	40 V=
Max. continuous operating voltage AC (50/60Hz)	Uc 20 V~	22 V~	25 V~	29 V~
Nominal current	IL 1,5 A	1,5 A	1,5 A	1,5 A
Longitudinal impedance (DC resistance) per line	Z 0,3 Ω	0,3 Ω	0,3 Ω	0,3 Ω
Series inductance, typ.	L 56 μH	56 μH	56 μH	56 μH
Response time fine protection	tA ≤ 2 ns	≤ 2 ns	≤ 2 ns	≤ 2 ns
C2 Nominal discharge current (8/20 μs) per line	In 10 kA	10 kA	10 kA	10 kA
C2 Nominal discharge current (8/20 μs) total	Imax 20 kA	20 kA	20 kA	20 kA
D1 lightning impulse current (10/350 μs) per line	Iimp 2,5 kA	2,5 kA	2,5 kA	2,5 kA
D1 lightning impulse current (10/350 μs) total	Itotal 5 kA	5 kA	5 kA	5 kA
Protection level, residual voltage line-ground at In resp. 1 kV/μs	Up ≤ 18 V	≤ 36 V	≤ 42 V	≤ 55 V
Capacitance, line-earth	C ≤ 2,3 nF	≤ 1,3 nF	≤ 1,1 nF	≤ 1 nF
Max. operating frequency (-3 dB)	fG < 600 kHz	< 600 kHz	< 600 kHz	< 600 kHz
Insulation resistance	Risol > 10 GΩ	> 10 GΩ	> 10 GΩ	> 10 GΩ
Operating temperature range	TU -25 - +85 °C	-25 - +85 °C	-25 - +85 °C	-25 - +85 °C



# EMC FILTER WITH INTEGRATED SURGE PROTECTION

## MCR TECHNOLOGY WITH INTEGRATED LOW-PASS FILTER

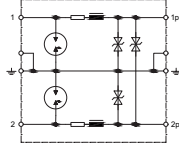

### Technical Data

<b>Product name</b>	<b>DP 2x1-60V/60V-0.3Ω-Tr</b>	
Article-No.	26 60 60	
IEC category	D1 / C2 / C1 / C3	
Nominal voltage DC	UN	60 V=
Max. continuous operating voltage DC	Uc	64 V=
Max. continuous operating voltage AC (50/60Hz)	Uc	45 V~
Nominal current	IL	1,5 A
Longitudinal impedance (DC resistance) per line	Z	0,3 Ω
Series inductance, typ.	L	56 µH
Response time fine protection	tA	≤ 2 ns
C2 Nominal discharge current (8/20 µs) per line	In	10 kA
C2 Nominal discharge current (8/20 µs) total	I <sub>max</sub>	20 kA
D1 lightning impulse current (10/350 µs) total	I <sub>total</sub>	5 kA
D1 lightning impulse current (10/350 µs) per line	I <sub>imp</sub>	2,5 kA
Protection level, residual voltage line-ground at I <sub>n</sub> resp. 1 kV/µs	U <sub>p</sub>	≤ 90 V
Leckstrom bei U <sub>max</sub> DC		≤ 5 µA
Capacitance, line-earth	C	≤ 1 nF
Max. operating frequency (-3 dB)	f <sub>G</sub>	< 600 kHz
Insulation resistance	R <sub>isol</sub>	> 10 GΩ

### Accessories DataPro and EnerPro

	Grounding bridge
Article-No.	17 00 80

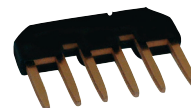

Bridge for optimal grounding. The cross section is 1,5 mm<sup>2</sup> per pin. The upper surface of the Grounding bridge is inslotated with plastics.



## DataPro2x1-RLC/50V-Tr

EMC filter for data and signal lines combined with surge protection enables smooth operation of sensitive electronic equipment in rough environment. Protection of anode side measuring circuit for rectifier in cathodic protection systems (CCPS). Protection of DC-measuring lines up to 50 V DC. Surge voltage protector for electrical equipment with an operating voltage of up to 50 V DC, with an impulse current withstand strength of 30 kA (8/20  $\mu$ s). The device was designed to protect sensitive electronic equipment.

- Signal and data line protection with low-pass filter
- Protective circuit for 2 signal lines without reference to ground potential
- EAC Certification
- Applicable at the boundaries LPZ 0A - 2 and higher
- Mounting on 35 mm DIN rail (EN 60715)
- Space required for installation: 17.5 mm
- Leakage current-free

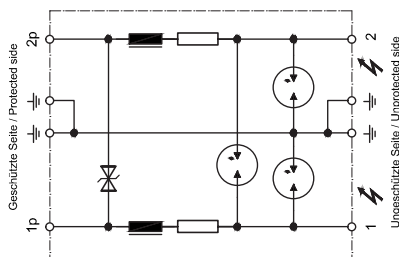



## DataPro 2x1-RLC-Tr

EMC filter for data and signal lines combined with surge protection enables smooth operation of sensitive electronic equipment in rough environment.

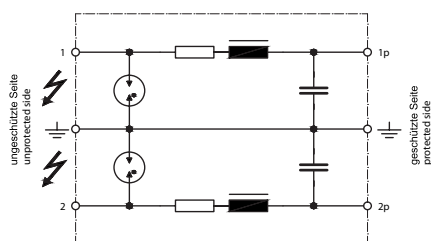
- Signal and data line protection with low-pass filter
- EAC Certification
- Protective circuit for 2 signal lines without reference to ground potential
- Mounting on 35 mm DIN rail (EN 60715)
- Degree of protection nach IEC EN 60529: IP 20
- Space required for installation: 17.5 mm
- Inflammability class according to UL 94 V0



Technical Data		
<b>Product name</b>	<b>DP 2x1-RLC/50V-Tr</b>	
Article-No.	28 70 50	
IEC category	D1 / C2 / C1 / C3	
Max. continuous operating voltage DC	Uc	50 V=
Nominal current	IL	0,1 A
C2 Nominal discharge current (8/20 $\mu$ s) total	Imax	30 kA
C2 Nominal discharge current (8/20 $\mu$ s) pro Line	In	10 kA
D1 lightning impulse current (10/350 $\mu$ s)	Iimp	5 kA
Protection level at 1kV/ $\mu$ s (1p-2p)	Up	$\leq$ 60 V
Protection level at 1kV/ $\mu$ s (1p,2p-PE)	Up	$\leq$ 650 V
Response time 1p-2p, 2-PE (at 1kV/ $\mu$ s)	tA	$\leq$ 2/25 ns
Operating temperature range	TU	-25 - +85 °C
Max. conductor cross section	2.5mm <sup>2</sup> solid or 1.5mm <sup>2</sup> flexible with sleeve	
Max. connection torque for terminals	1,5 Nm	
Enclosure material / colour	Polycarbonate UL 94-V0 / yellow	
Protection circuit casting compound	Polyurethan, flexible	
Degree of protection (IEC EN 60529)	IP 20	
Dimension (DIN 43880)	1 TE	

Technical Data		
<b>Product name</b>	<b>DP 2x1-RLC-Tr</b>	
Article-No.	27 00 00	
IEC category	D1 / C2 / C1 / C3	
Nominal voltage DC	UN	150 V=
Max. continuous operating voltage DC	Uc	170 V=
Max. continuous operating voltage AC (50/60Hz)	Uc	120 V~
Nominal current	IL	0,5 A
C2 Nominal discharge current (8/20 $\mu$ s) total	Imax	20 kA
D1 lightning impulse current (10/350 $\mu$ s) total	Itotal	5 kA
Leakage current at Umax DC	$\leq$ 0,001 $\mu$ A	
Max. operating frequency (-3 dB)	fG	100 kHz
DC resistance	R	4,3 $\Omega$
Series inductance, typ.	L	185 $\mu$ H
Capacitance, line-earth	C	$\leq$ 2,2 nF
Protection level Ad-PE at 1kV/ $\mu$ s and In	Up	$\leq$ 800 V
Operating temperature range	TU	-25 - +85 °C
Max. conductor cross section	2.5mm <sup>2</sup> solid or 1.5mm <sup>2</sup> flexible with sleeve	
Max. connection torque for terminals	1,5 Nm	
Dimension (DIN 43880)	1 TE	



# EMC FILTER WITH INTEGRATED SURGE PROTECTION MCR TECHNOLOGY WITH INTEGRATED LOW-PASS FILTER

## DataPro 2-2MB-Tr

EMC filter for data and signal lines combined with surge protection enables smooth operation of sensitive electronic equipment in rough environment.

- Signal and data line protection with low-pass filter
- Applicable for transmission rates of 2 MBit/s (ISDN, PCM)
- Max. nominal current 500 mA
- Applicable at the boundaries LPZ 0B - 2 and higher
- Mounting on 35 mm DIN rail (EN 60715)
- Space required for installation: 17.5 mm
- Inflammability class according to UL 94 V0
- EAC Certification

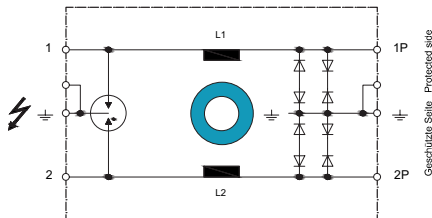

Product name	DP 2-2MB-Tr
Article-No.	24 00 17
IEC category	C1 / C2 / C3
Nominal voltage DC	UN 150 V=
Max. continuous operating voltage DC	Uc 170 V=
Max. continuous operating voltage AC (50/60Hz)	Uc 120 V~
Nominal current	IL 0,5 A
C2 Nominal discharge current (8/20 μs) total	I <sub>max</sub> 10 kA
C2 Nominal discharge current (8/20 μs) per line	I <sub>n</sub> 5 kA
Protection level line-earth at 1 kV/μs	Up ≤ 600 V
Max. frequency	f <sub>G</sub> 8 MHz
Operating temperature range	TU -25 - +85 °C
DC resistance per line	R 0,5 Ω
Signal transmission rate	up to 2 Mbit/s
Max. conductor cross section	2.5mm <sup>2</sup> solid or 1.5mm <sup>2</sup> flexible with sleeve
Max. connection torque for terminals	1,5 Nm
Dimension (DIN 43880)	1 TE

### Dimension

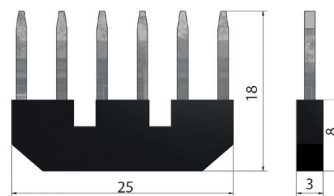
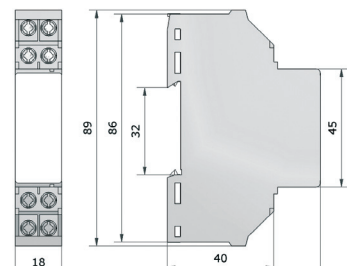

### Accessories DataPro and EnerPro

Article-No.	Grounding bridge 17 00 80
-------------	------------------------------

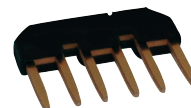

Bridge for optimal grounding. The cross section is 1,5 mm<sup>2</sup> per pin. The upper surface of the Grounding bridge is inslotated with plastics.





## DataPro 2x8-36V/36V-Tr/GO

Designed to protect sensitive input and output interfaces at electronic devices. Suitable, e.g., for fire alarm systems. Alternatively, GO or GU version to provide clear wiring (GO = protected side on top, GU = protected side at the bottom).



example image

- High performance surge protector
- Dimensions only 45 x 110 x 121 mm
- Merging of eight lines
- Two-stage low-pass filter
- EAC Certification
- Inflammability class according to UL 94 V0

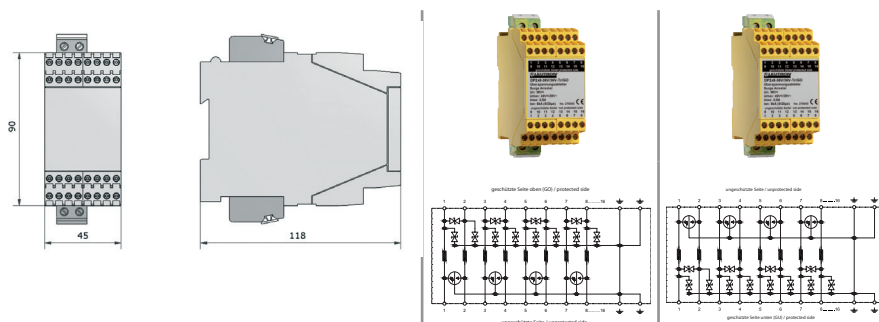

### Technical Data

Product name		DP 2x8-36V/36V-Tr/GO	DP 2x8-36V/36V-Tr/GU
Article-No.		27 90 00	27 90 01
Nominal voltage DC	UN	36 V=	36 V=
Max. continuous operating voltage DC	Uc	40 V=	40 V=
Max. continuous operating voltage AC (50/60Hz)	Uc	28 V~	28 V~
Nominal current	IL	1,5 A	1,5 A
C2 Nominal discharge current (8/20 μs) total	I <sub>max</sub>	20 kA	20 kA
C2 Nominal discharge current (8/20 μs) per line	I <sub>n</sub>	2,5 kA	2,5 kA
Protection level at I <sub>n</sub> (line-earth)	U <sub>p</sub>	≤ 75 V	≤ 75 V
Leakage current at U <sub>c</sub> DC		0,001 μA	0,001 μA
Max. operating frequency (-3 dB)	f <sub>G</sub>	600 kHz	600 kHz
DC resistance, typ.	R	4,6 Ω	4,6 Ω
Series inductance, typ.	L	28 μH	28 μH
Capacitance, line-earth	C	1 nF	1 nF
Operating temperature range	TU	-25 - +80 °C	-25 - +80 °C
Cross section for data line terminals		2.5 mm <sup>2</sup> flexible with sleeve	2.5 mm <sup>2</sup> flexible with sleeve
Cross section for earth connection terminals		6 mm <sup>2</sup> flexible with sleeve	6 mm <sup>2</sup> flexible with sleeve
Max. connection torque for terminals		1,5 Nm	1,5 Nm
Enclosure material / colour		Polycarbonate UL 94-V0 / yellow	Polycarbonate UL 94-V0 / yellow



# EMC FILTER WITH INTEGRATED SURGE PROTECTION MCR TECHNOLOGY WITH INTEGRATED LOW-PASS FILTER

## DataPro Z

To protect data and signal lines at measuring systems, automatic control devices and telecom installations. It is a compact protective circuit on a single printed circuit board (52 x 29 mm) which has been designed for the surge protection of sensitive electronic equipment.

The DataPro Z is designed as a two-step coarse and fine protective circuit. The coarse protection is provided by a gas-filled surge arrester (GDT) and the fine protection by EMI filter and suppressor diodes. Due to the absence of varistors, no leakage currents occur. Hence, there is no need of remote supervision respectively periodic inspection.

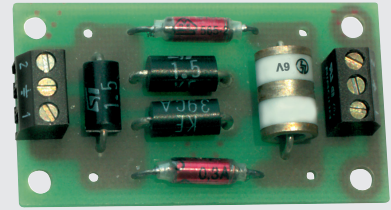

example image

- Compact construction
- All-purpose application
- Nominal current up to 300 mA
- Many voltage variation
- High discharge capacity (line-earth: 20 kA at 8/20  $\mu$ s)
- Maintenance-free
- Budget-priced solution
- EAC Certification

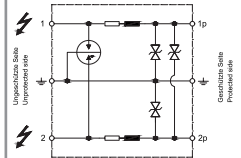
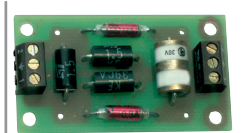
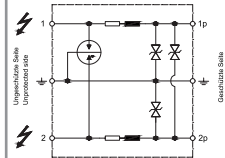
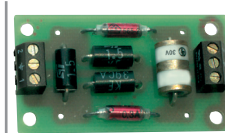
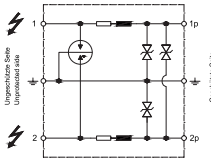
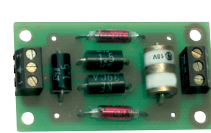
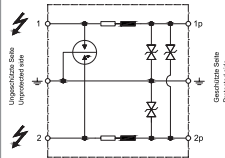
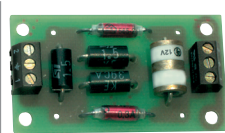
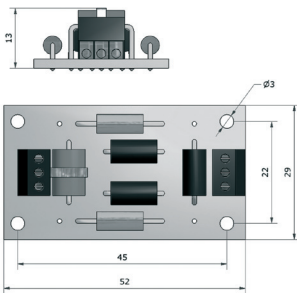

### Technical Data

Product name		DataPro Z-12V/12V	DataPro Z-15V/15V	DataPro Z-24V/24V	DataPro Z-30V/33V
Article-No.		22 12 12	22 15 15	22 24 24	22 30 30
Nominal voltage DC	UN	12 / 12 V=	15 / 15 V=	24 / 24 V=	30 / 30 V=
Nominal current	IL	0,3 A	0,3 A	0,3 A	0,3 A
C2 Nominal discharge current (8/20 $\mu$ s) total	I <sub>max</sub>	20 kA	20 kA	20 kA	20 kA
C2 Nominal discharge current (8/20 $\mu$ s) per line	I <sub>n</sub>	10 kA	10 kA	10 kA	10 kA
Protection level at I <sub>n</sub> (line-line)	U <sub>p</sub>	18 V	22 V	36 V	43 V
Protection level at I <sub>n</sub> (line-earth)	U <sub>p</sub>	18 V	22 V	36 V	43 V
Transverse impedance per line	R	4,1 $\Omega$	4,1 $\Omega$	4,1 $\Omega$	4,1 $\Omega$
Series inductance, typ.	L	40 $\mu$ H	40 $\mu$ H	40 $\mu$ H	40 $\mu$ H
Leakage current line-earth		<5 $\mu$ A	<5 $\mu$ A	<5 $\mu$ A	<5 $\mu$ A
Leakage current line-line		<5 $\mu$ A	<5 $\mu$ A	<5 $\mu$ A	<5 $\mu$ A

# EMC FILTER WITH INTEGRATED SURGE PROTECTION MCR TECHNOLOGY WITH INTEGRATED LOW-PASS FILTER

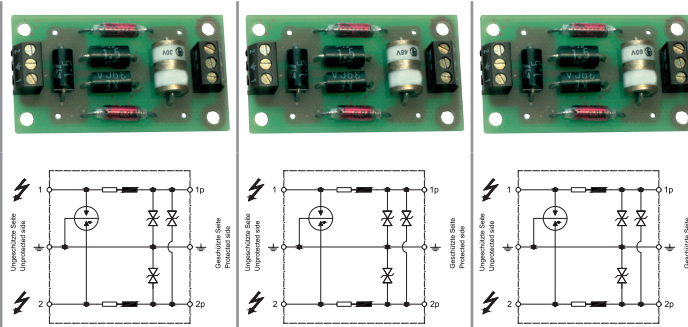

## Technical Data

Product name	DataPro Z-36V/36V	DataPro Z-48V/48V	DataPro Z-60V/60V
Article-No.	22 36 36	22 48 48	22 60 60
Nominal voltage DC	UN 36 / 36 V=	48 / 48 V=	60 / 60 V=
Nominal current	IL 0,3 A	0,3 A	0,3 A
C2 Nominal discharge current (8/20 μs) total	I <sub>max</sub> 20 kA	20 kA	20 kA
C2 Nominal discharge current (8/20 μs) per line	I <sub>n</sub> 10 kA	10 kA	10 kA
Protection level at I <sub>n</sub> (Line-Line)	U <sub>p</sub> 52 V	65 V	83 V
Protection level at I <sub>n</sub> (line-earth)	U <sub>p</sub> 52 V	65 V	83 V
Transverse impedance per line	R 4,1Ω	4,1Ω	4,1Ω
Series inductance, typ.	L 40 μH	40 μH	40 μH
Leakage current line-earth	<5 μA	<5 μA	<5 μA
Leakage current line-line	<5 μA	<5 μA	<5 μA

## SMOOTH OPERATION GUARANTEED

The measuring and testing devices are applied to check the sparkover voltage of lightning or surge protectors. These periodical tests of the protective function are demanded by the standards to ensure a steady and error-free operation.

**Down-time caused by overload of the surge protection can be eliminated by periodical reviews – with measuring and testing devices from Leutron.**

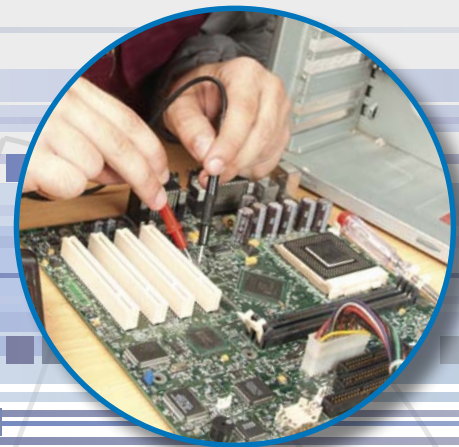
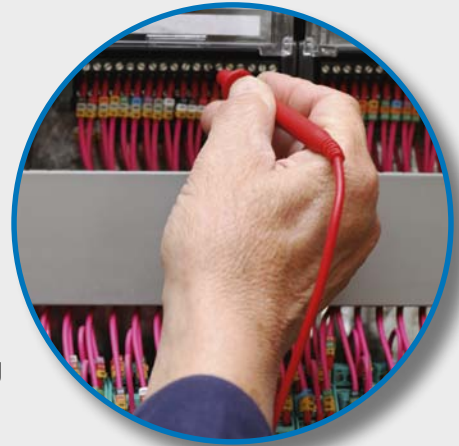

## TESTED FOR SAFETY – MANUALLY OR AUTOMATICALLY:

- Manual measurement with the arrester tester, the varistor tester or the combined tester
- Fully automatic measurement with the portable test equipment for SSCT magazines
- Available adaptors for all types of gas-filled surge protectors



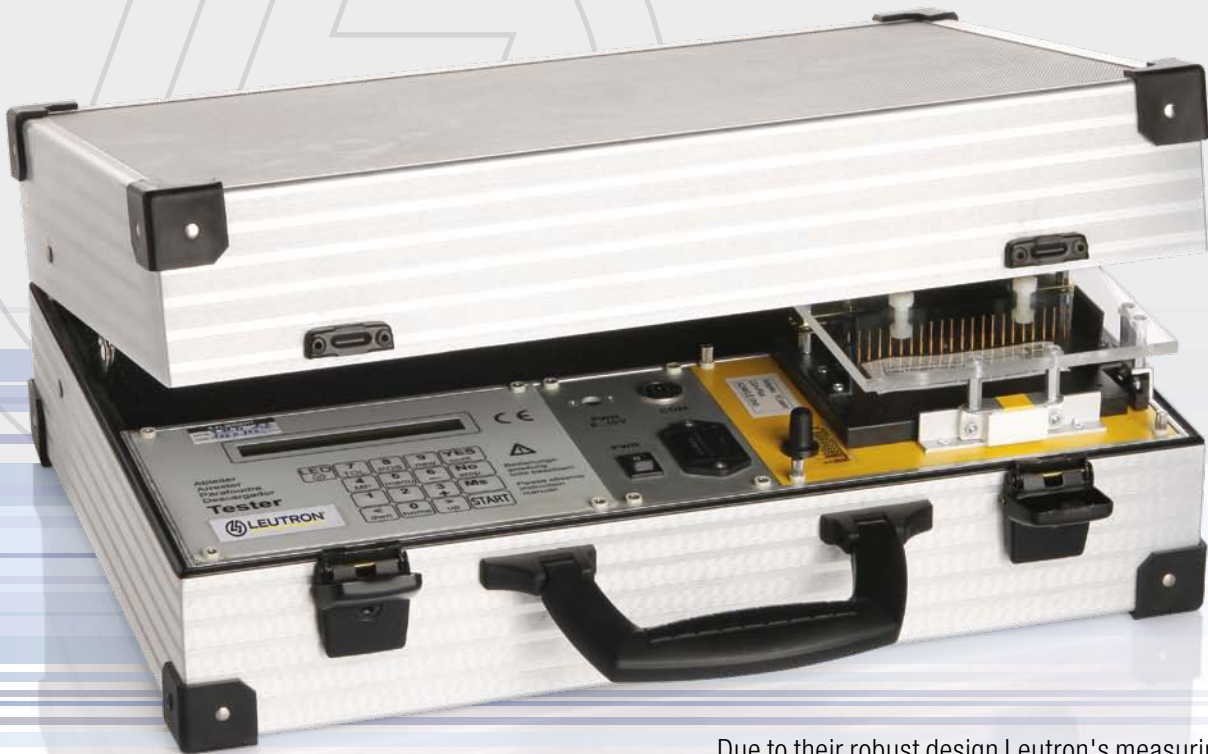

Due to their robust design Leutron's measuring and testing devices are perfectly suited for regular mobile use.

## MONITORING

# PORTABLE TEST EQUIPMENT FOR SSCT (LSA) MAGAZINES

Variable adapters  
for different types of  
magazines

Fully automated test  
of SSCT (LSA) magazines  
for overvoltage protection

PC interface for remote  
control and  
data archiving

Robust and mobile  
set-up in an easy to  
handle aluminium case





## COMBINED TESTER

- To test the sparkover voltage of lightning or surge protectors, e.g. MOV and gas discharge tubes

Shipment in robust carrying case

Combined tester for gas discharge tubes, isolating spark gaps and varistors with a sparkover voltage of up to 1,100 V

Various adapters and measuring leads available





Monitoring		Page
<b>Function tester</b>		<b>199</b>
H35	Function tester for GDT	199
H45	Function tester for MOV	199
H65	Universal tester for GDT and MOV	199
<b>Portable test equipment for GDT in LSA magazines</b>		<b>200</b>
A46	for LSA magazines	200
MC6000	Function tester of SPD up to 6 kV	201
<b>Others</b>		<b>202</b>
Mobile Surge Generator M10	Function tester of SPDs, GDTs, spark gaps and varistors	202





## Function tester for GDT and GDT based spark-gaps

### H35, H45, H65

- Digital measuring instrument with large LCD display
- 9V battery operation or net work power unit
- Measuring adapter (optional) for all popular GDT
- Automatic fixing of indicated value
- Scope of delivery includes: 1 carrying case, 1 test leads (2 pieces 1m each), 2 test terminals, 1 external power supply 230V



#### H35 Function tester for GDT and GDT based spark-gaps

For the testing of spark over voltage of lightning and surge voltage arresters based on expulsion-type spark gap. Mobile, easy-to-handle digital meter with a large LCD display for maintenance.

#### H45 Function tester for MOV and overvoltage protection diodes.

For testing of the spark-over voltage of lightning- and surge voltage arresters. Digital measuring device with large LCD display. Mobile and easy-to-handle, usable for the service area.

#### H65 Universal function tester for GDT, MOV and diodes as well as mixed circuits

For the testing of spark over voltage of lightning and surge voltage arresters, e.g. metal oxide varistors (MOV) and gas-filled surge arrester (GDT) or individually MOV and GDT. It is a mobile, easy-to-handle and microprocessor operated digital meter with a large LCD display for maintenance.

#### Technical Data



Product name	H35	H45	H65
Article No.	87 00 10	16 02 00	87 01 50
Measured value display	LCD, digital [V]	LCD, digital [V]	LCD, digital [V]
Measuring range	40 - 1000 V	40 - 1100 V	40 - 1100 V
Max. testing voltage	1200 V	1200 V	1200 V
Test current	0,1 mA	0,8-1,1 mA	0,8 - 1,1 mA
Display division	1 V	1 V	1 V
Testing period	min. 1s up to measuring value is seen	min. 1s up to measuring value is seen	min. 1s up to measuring value is seen
Rate-of-Rise (voltage)	1000 V /s	k. A.	1000 V/s
Batterie	9 V IEC 6F22/NEMA-1604-A	9 V IEC 6F22/NEMA-1604-A	9 V IEC 6F22/NEMA-1604-A
External AC/DC adapter	8 - 11 V DC/300 mA	230V AC / 8 -12 V DC / 200 mA	8 - 11 V DC / 200 mA
Typical current consumption in stand-by position	0,2 mA	0,2 mA	-
Typical current consumption during measuring activity	35 mA	20 - 200 mA	20 - 200 mA
Typical current consumption display	-	200 mA	ca. 1 mA
Test terminals (4mm banana jack)	Minus pole: black / Plus pole: red	Minus pole: black / Plus pole: red	Minus pole: black / Plus pole: red
Operating temperature range	-10 - +35 °C	-10 - +35 °C	-10 - +35 °C
Dimensions (L x W x H)	180 x 90 x 30 mm	180 x 90 x 30 mm	180 x 90 x 30 mm
Enclosure material / colour	self-extinguishing plastic / black	self-extinguishing plastic / black	self-extinguishing plastic / black
Net weight / pc	600 g	630 g	630 g

#### Calibration on request:

	H35 / H45 / H65
Article No.	87 01 40

#### Accessories

	Measuring adapter ADE/FGH:	Measuring adapter ADE/E :
Article No.	87 00 60	87 00 70

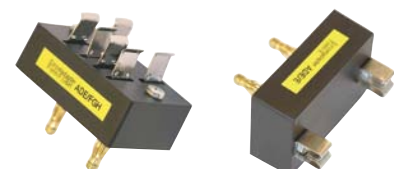

Measuring adapter ADE/FGH for 2 pole GDT, 8x8 mm, 8x6 mm und 8x20 mm  
 Measuring adapter ADE/E : Für Gas Discharge Tube of form E



## Portable test equipment for GDT in LSA magazines

### A46

- PC connection
- Individual tester can be stored in a PC or printed via included software
- Other test adapters are available on request
- Mobile device in aluminium protection case



For testing of LSA arrester magazines equipped with GDT. The whole test equipment is fixed in a portable case with place for a lot of accessories (e.g. AC- adapter, test adapter for different kind of GDT magazines).

At each test cycle each GDT arrester inserted in a magazine, the spark-over voltage in both polarities is analysed and compared with the tolerance values, adjusted in the test program.

For the testing of GDT equipped LSA magazines. The test equipment is embedded in a metal case

which has additional space for accessories like network adapters and test adapters for different arrester magazines.

Each GDT in the magazine is tested on both polarities, and the static dc sparkover voltage is compared with the tolerance values.

The A46 allows for an accurate measuring of the dc sparkover voltage, by detecting the first sparkover with a linear ramp. It is important to measure on both polarities in order to prevent damages to the gas-filled surge arrester.

The whole testing of the magazine takes place automatically, including the comparison of the measured values with the tolerance values and the fault detection. The test of a complete magazine filled with 20 GDTs takes about 13 seconds.

A quality assessment system can be set up with the software PRO-TEST.

The A46 can operate entirely remote controlled from a PC via its serial interface. A special optocoupler-based cable is necessary to provide an interference protection for the PC.



#### Technical Data

Product name	A46
Article No.	87 01 00
Slow ramp (CCITT/VDE)	100 V/s
Fast ramp	1000 V/s
Measuring range	5-800 V
Test current	50 mA
Resolution, internal	12 bit = 0,2 V
Display resolution	1 V
Accuracy	+/- 1 V +1 % rel.
Resolution	0,2
Batterie	9 V IEC 22
External AC/DC adapter	8-5 V / 50 mA
Typical current consumption in stand-by position	5 mA
Typical current consumption during measuring activity	30 mA
Max. usable positions	30 pos
Net weight / pc	5000 g



## MC6000

### Introduction

The MC6000 arrester tester is designed to measure:

- 1) the static break down voltage of gas discharge tubes
- 2) the 1mA-voltage of varistors, Z and TAZ diodes.

The tester automatically detects whether a varistor or a gas tube is connected.

### Operating principle

The tester generates a saw tooth voltage with a rise time of 8s. If the current through the test device exceeds 1 mA the voltage value is stored and displayed with the indicator „Varistor - Diode“. The ramp voltage drops to zero.

A small capacitor is connected parallel to the ramp voltage and acts as a low impedance to force a starting glow discharge of a gas tube into break down. The current exceeds 1 A for less than 1µs, is detected and displayed as „Gas Tube“ together with the voltage value. The ramp drops to zero.

The tester is operating from a lead acid battery: 12 V - 4.5 Ah. The power consumption is 0.12 A in standby - going up to 1.2 A when testing a 6 kV varistor at 1 mA. So battery time depends on the kind of measurements made. 5h to 8h continuous operation should be possible.

The tester has an internal charger. The mains input (L, N, PE) is highly isolated from the tester circuit - 5 kV AC - so the charger may be running during tests. Normal charging current is 0.22 A, automatically decreasing to zero if the battery is above 13.5 V.

### Electrical safety considerations

The MC6000-tester generates high voltages and charges internal capacitors. Even if the tester is switched off when the output current exceeds 1 mA, the capacitor delivers pulse current (< 1µs; > 1 A) . In the lower range the stored energy is < 0.7 J and considered as safe. In the high range the stored energy is < 0.45 J and dangerous.



The following rules must be obeyed:

- 1) the test device must be free and not connected to any other circuitry.
- 2) the test leads and clamps must be securely fastened to the test device - an adaptor is highly recommended. It is not allowed to hold or handle the test device during the test.
- 3) The test device must be placed on an isolating sheet like Teflon, silicon rubber, glas. A 6 kV a wooden desk top is not sufficient.



### Technical Data

Product name	MC6000	
Article No.	87 01 60	
	Range 1:	10 V up to 800 V
Ramp		100 V/s
Parallel capacitor		22 nF
Stored energy		7 mJ max.
Static output current		1 mA max.
Resolution		1 V
	Range 2:	100 V up to 6 kV
Ramp		800 V/s
Parallel capacitor		25 nF
Stored energy		0,45 J max.
Static output current		1 mA max.
Resolution		3 V

### Display detail shots





## Mobile Surge Generator M10

Surges are caused by direct or indirect lightning strokes into an electric circuit or transient overvoltages due to short-circuits or switching operations of inductive loads. This leads to currents or electromagnetic fields which generate strong voltage or current transients. Over-voltages and currents can reach several thousand volt and several thousand ampere.

The mobile and easy to transport surge generator is perfectly suited for application at customer trainings and presentations as well as life-demonstrations and fast and simple tests of gas-filled surge arresters and surge arresters with isolating spark gaps and varistors.

Due to its robust flightcase with a heavy-duty pull-out handle, two casters and two recessed flip handles the mobile surge generator is perfectly protected and easy to transport.

- Easy and safe to operate with remote triggering via cable
- Compact and lightweight design with all functions aboard

The device is especially suitable to underline your presentation with the right sound effect.

### Technical data of the case

External dimensions approx.:	(W x D x H) 550 x 354 x 270 mm
Internal dimensions incl. top:	(W x D x H) 476 x 280 x 196 mm
Volume:	26 litre
Weight of the case:	11 kg
Total weight:	38 kg
Panel material:	7 mm birch plywood with black PVC coating, 20 mm aluminium edge linings
Base frame height outside:	approx. 145 mm
Demountable hood	

### Equipment

2x recessed flip handle, half height  
 2x rubber pads 38 x 30 mm  
 1x pull-out handle, steel, heavy duty  
 1x pair casters with a diameter of 75 mm; load approx. 80 kg/pair  
 2x slide foot for 75 mm rolls  
 4x medial, recessed butterfly latches (on request lockable)  
 Small stackable ball corners  
 Inner surfaces coated with 20 mm thick foamed material  
 Height of the lower part 120 mm



### Order data

Product name	M10 Stoßstromgenerator
Article No.	87 01 10



## Technical data of the surge generator

1. Charging voltage: 10 kV
2. Stored energy E: 500 J
3. Charge Q: 0.1 As
4. Pulse shape: 5/15  $\mu$ s
5. Peake current: 8 kA
6. Remote triggering via cable
7. Ignition of the isolating spark gap is visible through a glass tube

Suited for the testing of gas discharge tubes (GDT), isolating spark gaps and varistors.

## Shipment includes:

- Power supply cable 1.5 m
- Lock and key

## Quick reference guide for mobile surge generators

1. Connect the specimen via the cables
2. Red connector: ground
3. Blue connector: voltage  
**Warning:** The mobile surge generator must not be switched on if no specimen is connected!
4. The LOCAL switch points downwards. This is valid for manual operation without REMOTE CONTROL.
5. Insert power cable and connect to mains.
6. Switch the device on with the key. Turn the key clockwise to ON.
7. Charge: Switch the toggle switch CHARGE to the right. Charging takes approx. 10 seconds. The green LED is lit when the charging process is completed.
8. Wait another 10 seconds, and then switch the toggle switch CHARGE back to the left.
9. To discharge press the red button "DISCHARGE"  
**Warning:** Do not discharge the surge generator if no specimen is connected!

If the device does not trigger when the red button is pressed, turn the key counterclockwise to switch off the power.

The capacitors need at least 20 minutes to discharge themselves.

Afterwards the generator has to be bridged for security reasons. Do not touch the device beforehand.

**The mobile surge generator may only be handled by especially trained personnel.**

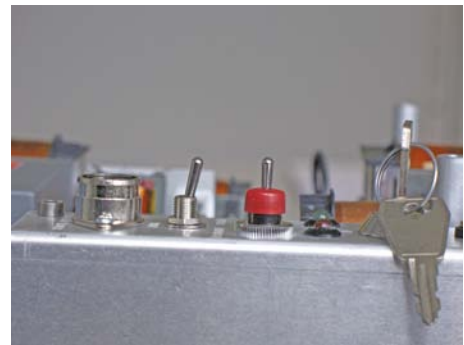

## THE STRENGTHS OF LEUTRON SINCE 1947

The long experience and, therefore, the lead in research and development makes Leutron one of the leading manufacturers of isolation spark gaps. Intelligently designed components, compact constructions and an ideal choice of rare-gas fillings are only some elements that, in their totality, provide an optimal protection for various applications in the areas of electronics and electrical engineering.

**Robust and powerful protection against direct lightning strikes – Leutron's isolation spark gaps.**



## GAS-FILLED ISOLATING SPARK GAPS FOR MORE SAFETY:

- Low DC and AC voltage protection level
- Very high ignition constancy even in demanding environments
- Maintenance-free due to automatic signalization in case of an overload
- Ideally suited for application in explosion-hazard environments
- Improved operator protection due to low sparkover voltage





Secure application  
even in explosion-hazard environments

## ISOLATING SPARK GAPS FILLED WITH RARE-GAS

Hermetically closed, gas-filled isolation spark gap

Fail-safe characteristic: The double fail-safe limits the surface temperature in case of a fault

Optional remote signalling on request

EAC certified







**ISOLATION SPARK GAPS  
FOR AREAS IN DANGER OF EXPLOSION: ATEX**

- High discharge capacity up to 100 kA (10/350  $\mu$ s), class H
- Low sparkover voltage

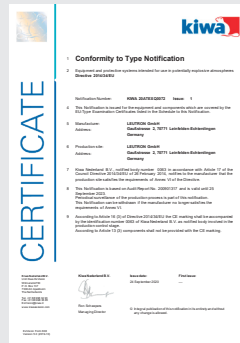

Fail-safe characteristic: The double fail-safe limits the surface temperature in case of a fault

Hermetically closed, gas-filled isolation spark gap

Degree of protection IP 67 (according to IEC EN 60529), suited for outdoor application



Atex certified  
EAC certified



# RARE-GAS-FILLED INSULATION SPARK GAPS

## TABLE OF CONTENTS

Rare-gas-filled insulation spark gaps		Page
<b>Flexible mounting</b>		<b>209</b>
TSF series	Insulation of electrically separated parts and the bridging of insulating flanges of gas pipelines	209
TA 100 C / TA 500 C	Protection of dc control für ac railways	210
SGO 70 / SGO 350	Protection of power supply of dc railways	211
SGO 70QA / SGO 350QA	Waterproof isolating spark-gap for underground installation (soil)	212
HSCS	For internal or similar applications.	213
<b>ATEX certificated for explosion hazardous zones</b>		<b>214</b>
TC 100 A / TC 500 A	ATEX approved Ex-protection category. Lightning protective equipotential bonding in hazardous areas, e.g. insulating flanges at gas pipelines, at cathodic corrosion protection and protection of pressure transmitters.	214
TC 100 A / TC 500 A	Safety requirements of TC 100 A and TC 500 A	216
Accessories of TC / TA	Connectors, diverse executions	218
<b>DIN rail mounting</b>		<b>219</b>
TSF for DIN rail mounting	Rare-gas-filled spark gap for the lightning protection equipotential bonding, the insulation of electrically separated parts and the bridging of insulating flanges of gas pipelines.	219
TF for DIN rail mounting	Protects measuring transformers; lightning and surge voltage protector for 1A respectively 5A cores in current transformers.	220
	Protection of current and voltage transformers	221



## TSF series

Rare-gas-filled spark gap for the lightning protection equipotential bonding, the insulation of electrically separated parts and the bridging of insulating flanges of gas pipelines.



example image

- High-quality industrial ceramics
- Rare-gas filled, hermetically sealed
- Free from radioactive substances
- High lightning current discharge capacity of 100 kA (10/350  $\mu$ s) (class H)
- High reliability, robust
- Stable performance, long service life
- Fail-safe characteristic
- Test standard DIN EN 62561-3
- EAC certificated

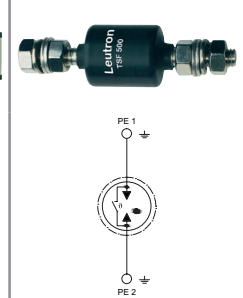
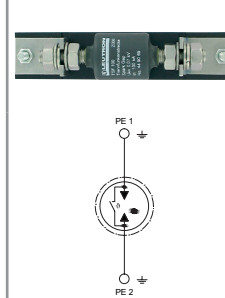
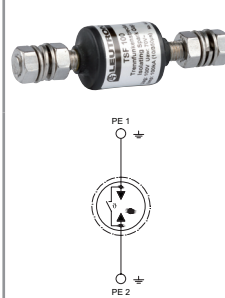
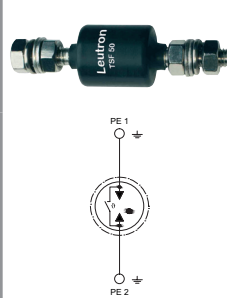
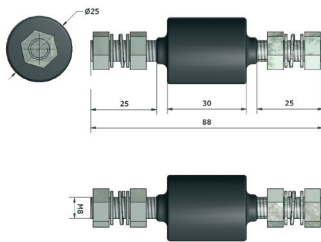

### Technical Data

Product name	TSF 50	TSF 100	TSF 100 H1	TSF 500
Article-No.	44 90 60	44 90 69	44 91 50	48 78 01
IEC category	Class 1L	Class H	Class H	Class H
Nominal AC sparkover voltage (50 Hz)	$U_{aw}$ 50 $\pm 15\%$ V	70 $\pm 20\%$ V	70 $\pm 20\%$ V	350 $\pm 15\%$ V
Lightning impulse current (10/350 $\mu$ s) total	$I_{total}$ 25 kA	100 kA	100 kA	100 kA
Insulation resistance at 10V, 100V	$\geq 1$ G $\Omega$	$\geq 1$ G $\Omega$	$\geq 1$ G $\Omega$	$> 1$ G $\Omega$ $\geq 1$ G $\Omega$
Self-capacitance at 1 kHz	typ. 6 pF	6 pF	6 pF	4 pF
Test category/climatic category	DN IEC 60068-1 / 40/90/21	DIN IEC 60068-1 / 40/90/21	DIN IEC 60068-1 / 40/90/21	DIN IEC 60068-1 / 40/90/21
Relative humidity	10% - 95% rh	10%...95% rh	10%...95% rh	10%...95% rh
Degree of protection (IEC EN 60529)	IP 67	IP 67	IP 67	IP 67
Operating temperature range	TU -40 - +70 °C	-40 - +70 °C	-40 - +70 °C	-40 - +70 °C
Type of connection	M8 bolt/nut (NIROSTA stainless steel)		M8 bolt/nut (NIROSTA stainless steel)	
Dimensions ( $\varnothing \times L$ )	25 x 87,5 mm	25 x 88 mm	25 x 88 mm	25 x 88 mm
Nominal DC sparkover voltage at 100V/s	$U_{agN}$ -	100 $\pm 20\%$ V=	100 $\pm 20\%$ V=	500 $\pm 15\%$ V=
Typ. Impulse sparkover voltage	$U_{as}$ -	650 V	650 V	950 V
Max. Impulse sparkover voltage	$U_{as}$ -	950 V	950 V	1300 V
Nominal impulse discharge current (10 x 8/20 $\mu$ s)	$I_n$ -	100 kA	100 kA	100 kA
5x Nominal alternating discharge current at 50Hz, 1s, 3min pause	$I_{wn}$ -	100/1 Aeff/s	100/1 Aeff/s	100/1 Aeff/s
3x lightning impulse current (10/350 $\mu$ s), long-duration current (CENELEC/BTTF 62-2)	-	75 kA/ 38 As/ 1,45 MJ/ $\Omega$ + 150A / 0,5s / 75 As		

### Accessories

Article-No.	TSF-H1 44 91 75
-------------	--------------------

For solid fixation of isolation spark gaps TSF 100 and TSF 500 at the installation. Easy replace is possible.

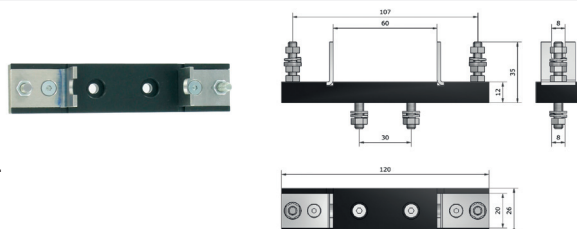



## TA 100 C / TA 500 C

Rare-gas-filled spark gap for the lightning protection equipotential bonding, the insulation of electrically separated parts and the bridging of insulating flanges of gas pipelines. The product is for outdoor use where a high level of protection against lightning and other climatic influences as well as mechanical stress is needed.



example image

- High-quality industrial ceramics
- Rare-gas filled, hermetically sealed
- Free from radioactive substances
- High discharge capacity up to 100 kA
- Highly reliable, robust and waterproof
- Extremely low sparkover voltage
- Stable performance, long service life
- Fail-safe characteristic
- Test standard DIN EN 62561-3
- EAC certificated

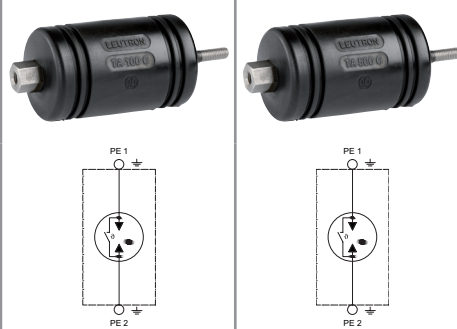
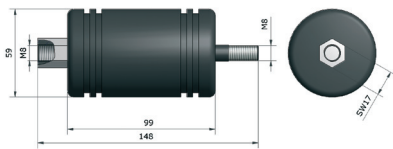

### Technical Data

Product name	TA 100C	TA 500C
Article-No.	48 78 14	48 78 27
IEC category	Class H	Class H
Nominal DC sparkover voltage at 100V/s	UagN 100 ±20% V=	500 ±15% V=
Nominal AC sparkover voltage (50 Hz)	Uaw 70 ±20% V	350 ±15% V
Typ. Impulse sparkover voltage	Uas 650 V	950 V
Max. Impulse sparkover voltage	Uas 950 V	1300 V
Lightning impulse current (10/350 µs) total	I <sub>total</sub> 100 kA	100 kA
Nominal impulse discharge current (10 x 8/20 µs)	I <sub>n</sub> 100 kA	100 kA
5x Nominal alternating discharge current at 50Hz, 1s, 3min pause	100/1 Aeff/s	100/1 Aeff/s
Nominal alternating discharge current (50 Hz)	200 / 0,5 A/s	200 / 0,5 A/s
Alternating current critical load (50 Hz) (1x 0.3s)	I <sub>wgr</sub> 4.000 / 0,25 Aeff/s	4.000 / 0,25 Aeff/s
Spark-gap extinguishing conditions	V <sub>i0</sub> <70 V/<20 A	< 230 V/<100 A
Insulation resistance at 10V, 100V	>1 GΩ	>1 GΩ
Self-capacitance at 1 kHz	9 pF	7 pF
Test category/climatic category	DIN IEC 60068-1 / 40/90/21	DIN IEC 60068-1 / 40/90/21
Relative humidity	10%...95% rh	10%...95% rh
Degree of protection (IEC EN 60529)	IP 67	IP 67
Operating temperature range	TU -40 - + 80 °C	-40 - + 80 °C

### Accessories

	IF1-10-W	IF3-22-F	IF1-22-W	IF3-18-F
Article-No.	82 30 10	82 30 16	82 30 11	82 30 15



Connectors are made of hot-dip galvanized steel, with 10, 18 and 22 mm drill hole. More executions on page 228.



## SGO 70 / 350

Rare-gas-filled spark gap for the lightning protection equipotential bonding, the insulation of electrically separated parts and the bridging of insulating flanges of gas pipelines. Weather resistant, moulded metal/ceramic isolating spark gap with terminal lugs for M8 screw connection. Waterproof moulded in polyurethan diecast.



example image

- High-quality industrial ceramics
- Rare-gas filled, hermetically sealed
- Free from radioactive substances
- High lightning current discharge capacity of 100 kA (10/350  $\mu$ s) (class H)
- Extremely low sparkover voltage
- Highly reliable, robust and waterproof
- Fail-safe characteristic
- Stable performance, long service life
- Test standard DIN EN 62561-3
- EAC certificated

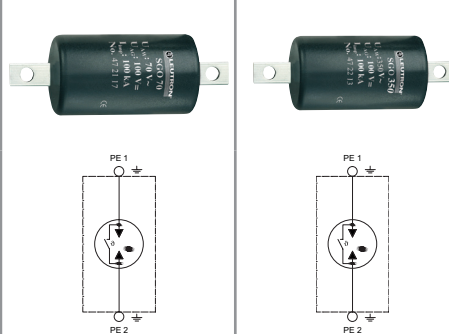
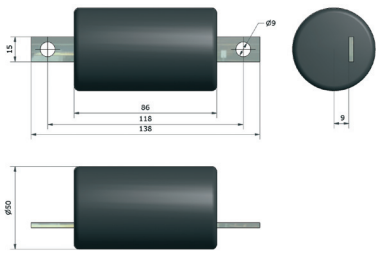

### Technical Data

Product name	SGO 70	SGO 350
Article-No.	47 21 17	47 22 13
IEC category	Class H	Class H
Nominal DC sparkover voltage at 100V/s	UagN 100 $\pm$ 20% V=	500 $\pm$ 15% V=
Nominal AC sparkover voltage (50 Hz)	Uaw 70 $\pm$ 20% V	350 $\pm$ 15% V
Typ. Impulse sparkover voltage	Uas 650 V	950 V
Max. Impulse sparkover voltage	Uas 950 V	1300 V
Lightning impulse current (10/350 $\mu$ s) total	Itotal 100 kA	100 kA
Nominal impulse discharge current (10 x 8/20 $\mu$ s)	In 100 kA	100 kA
5x Nominal alternating discharge current at 50Hz, 1s, 3min pause	100/1 Aeff Iwn	100/1 Aeff
3x lightning impulse current (10/350 $\mu$ s), long-duration current (CENELEC/BTTF 62-2)	limp 75kA / 38As / 1,45 MJ/ $\Omega$ + 150A / 0,5s / 75 As	75kA / 38As/1,45MJ/ $\Omega$ + 150A / 0,5s / 75As
20x lightning impulse current (10/45 $\mu$ s) half-wave (DIN 48810)	60kA/10As/0,1MJ/ $\Omega$	60kA/10As/0,1MJ/ $\Omega$
Nominal alternating discharge current (50 Hz)	200 / 0,5 A/s	200 / 0,5 A/s
Alternating current critical load (50 Hz) (1x 0.3s)	Iwgr 4.000 / 0,25 Aeff/s	4.000 / 0,25 Aeff/s
Insulation resistance at 10V, 100V	>1 G $\Omega$	>1 G $\Omega$
Spark-gap extinguishing conditions	Vlö <70 V / <20 A	< 230 V / < 100 A
Self-capacitance at 1 kHz	9 pF	7 pF
Test category/climatic category	DIN IEC 60068-1 / 40/90/21	DIN IEC 60068-1 / 40/90/21
Relative humidity	10%...95% rh	10%...95% rh



## SGO 70QA / SGO 350QA

Rare-gas-filled spark gap for the lightning protection equipotential bonding, the insulation of electrically separated parts and the bridging of insulating flanges of gas pipelines. Waterproof isolating spark-gap for underground installation (soil). Moulded in PU diecast, with cables.



example image

- High-quality industrial ceramics
- Rare-gas filled, hermetically sealed
- Free from radioactive substances
- High discharge capacity up to 100 kA (class H)
- Extremely low sparkover voltage
- Highly reliable, stable functioning
- Fail-safe behaviour
- SNAM-execution
- Test standard DIN EN 62561-3
- Including 2.0 m connection cables with 25mm<sup>2</sup>
- EAC certificated

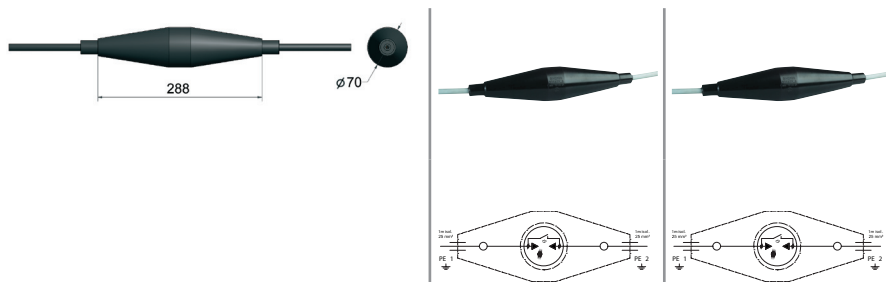

### Technical Data

Product name	SGO 70 QA	SGO 350 QA
Article-No.	47 21 04	47 21 11
IEC category	Class H	Class H
Nominal DC sparkover voltage at 100V/s	UagN 100 ±20% V=	500 ±15% V=
Nominal AC sparkover voltage (50 Hz)	Uaw 70 ±20% V	350 ±15% V
Typ. Impulse sparkover voltage	Uas 650 V	950 V
Max. Impulse sparkover voltage	Uas 950 V	1300 V
Nominal impulse discharge current (10 x 8/20 µs)	In 100 kA	100 kA
Lightning impulse current (10/350 µs) total	Itotal 100 kA	100 kA
3x lightning impulse current (10/350 µs), long-duration current (CENELEC/BTTF 62-2)	Iimp 75 kA/38 As/1,45 MJ/Ω plus 150 A / 0,5s /75As	75 kA/38 As/ 1,45 MJ/Ω plus 150A/ 0,5s, 75 As
20x lightning impulse current (10/45 µs) half-wave (DIN 48810)	60 kA/10As/0,1 MJ/Ω	60kA /10As / 0,1 MJ/Ω
5x Nominal alternating discharge current at 50Hz, 1s, 3min pause	Iwn 100/1 Aeff/s	100/1 Aeff/s
Nominal alternating discharge current (50 Hz)	200 / 0,5 A/s	200 / 0,5 A/s
Alternating current critical load (50 Hz) (1x 0.3s)	Iwgr 4.000 / 0,25 Aeff/s	4.000 / 0,25 Aeff/s
Spark-gap extinguishing conditions	Vi0 < 70 V / <20 A	< 230 V / < 100 A
Insulation resistance at 10V, 100V	>1 GΩ	>1 GΩ
Self-capacitance at 1 kHz	9 pF	7 pF
Test category/climatic category	DIN IEC 60068-1 / 40/90/21	DIN IEC 60068-1 / 40/90/21
Relative humidity	10%...95% rh	10%...95% rh
Terminals	cable 2 m/ 25 mm <sup>2</sup>	cable 2 m/ 25 mm <sup>2</sup>



## HSCS

Rare-gas-filled spark gap for the lightning protection equipotential bonding, the insulation of electrically separated parts and the bridging of insulating flanges of gas pipelines. For internal or similar applications.

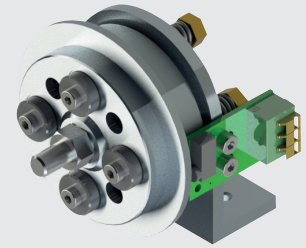

example image

- High-quality industrial ceramics
- Rare-gas filled, hermetically sealed
- Free from radioactive substances
- High lightning current discharge capacity of 100 kA (10/350  $\mu$ s) (class H)
- High reliability, robust
- Stable performance, long service life
- Fail-safe characteristic
- With remote signalling contact (FM)
- Test standard DIN EN 62561-3

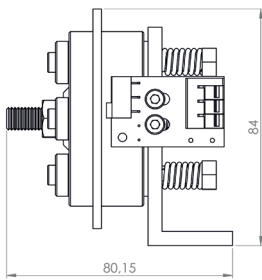

### Technical Data

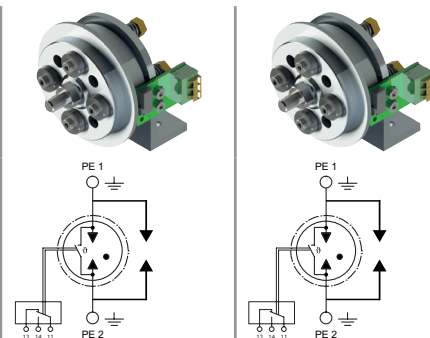

Product name	HSCS-100-FM	HSCS-500-FM
Article-No.	48 78 07	48 78 08
IEC category	Class H	Class H
Nominal DC sparkover voltage at 100V/s	UagN 100 $\pm$ 20% V=	500 $\pm$ 15% V=
Nominal AC sparkover voltage (50 Hz)	Uaw 70 $\pm$ 20% V	350 $\pm$ 15% V
Typ. Impulse sparkover voltage	Uas 650 V	950 V
Max. Impulse sparkover voltage	Uas 950 V	1300 V
Lightning impulse current (10/350 $\mu$ s) total	I <sub>total</sub> 100 kA	100 kA
Nominal impulse discharge current (10 x 8/20 $\mu$ s)	I <sub>n</sub> 100 kA	100 kA
5x Nominal alternating discharge current at 50 Hz, 1s, 3min pause	100/1 Aeff/s	100/1 Aeff/s
Nominal alternating discharge current (50 Hz)	200 / 0,5 A/s	200 / 0,5 A/s
Spark-gap extinguishing conditions	V <sub>li</sub> <70 V / <20 A	<230 V / <100 A
Insulation resistance at 10V, 100V	> 1 G $\Omega$	>1 G $\Omega$
Short-circuit current rating	ISCCR 7,2 kA r.m.s./300 ms	7,2 kA r.m.s./300 ms
Self-capacitance at 1 kHz	6 pF	4 pF
Test category/climatic category	DIN IEC 60068-1 / 40/90/21	DIN IEC 60068-1 / 40/90/21
Relative humidity	10%...95% rh	10%...95% rh
Degree of protection (IEC EN 60529) (IEC EN 60529)	IP 20	IP 20
Operating temperature range	TU -40 - +80 °C	-40 - +80 °C



# RARE-GAS-FILLED INSULATION SPARK GAPS ATEX CERTIFICATED FOR EXPLOSION HAZARDOUS ZONES

## TC 100 A / TC 500 A

ATEX approved Ex-protection category. Lightning protective equipotential bonding in hazardous areas, e.g. insulating flanges at gas pipelines, at cathodic corrosion protection and protection of pressure transmitters.



example image

- High-quality industrial ceramics
- Rare-gas filled, hermetically sealed
- Free from radioactive substances
- Extremely low sparkover voltage
- High discharge capacity up to 100 kA
- High reliability, robust
- Stable performance, long service life
- Fail-safe behaviour (twofold)
- Patented product
- Test standard DIN EN 62561-3
- EAC certificated
- ATEX Degree of protection (IEC EN 60529): II 2 G Ex mb IIC T4 Gb (ZELM 02 ATEX 0095X)
- Pre-assembled TC 100 A with cable connectors of 300/500 mm

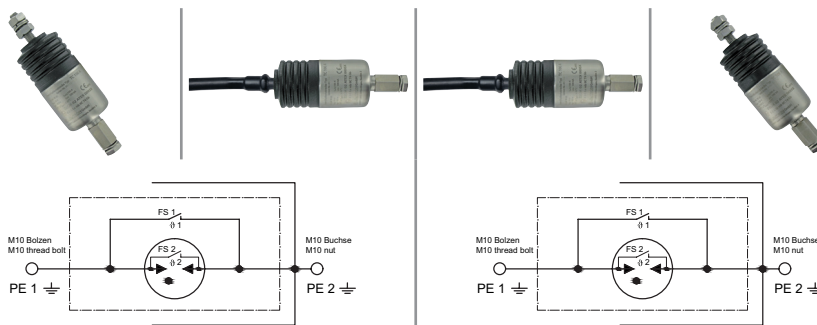
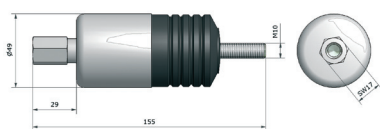

### Technical Data

Product name	TC 100 A	TC 100 A-K1/300	TC 100 A-K1/500	TC 500 A
Article-No.	48 78 30	49 51 07	49 51 00	48 78 50
IEC category	Class H	Class H	Class H	Class H
Nominal DC sparkover voltage at 100V/s	U <sub>agN</sub> 100 ±20% V=	100 ±20% V=	100 ±20% V=	500 ±15% V=
Nominal AC sparkover voltage (50 Hz)	U <sub>aw</sub> 70 ±20% V	70 ±20% V	70 ±20% V	350 ±15% V
Typ. Impulse sparkover voltage	U <sub>as</sub> 650 V	650 V	650 V	950 V
Max. Impulse sparkover voltage	U <sub>as</sub> 950 V	950 V	950 V	1300 V
Lightning impulse current (10/350 µs) total	I <sub>total</sub> 100 kA	100 kA	100 kA	100 kA
Nominal impulse discharge current (10 x 8/20 µs)	I <sub>n</sub> 10x 100 kA	10x 100 kA	10x 100 kA	100 kA
5x Nominal alternating discharge current at 50Hz, 1s, 3min pause	100/1 Aeff/s	100/1 Aeff/s	100/1 Aeff/s	100/1 Aeff/s
Nominal alternating discharge current (50 Hz)	200 / 0,5 A/s	200 / 0,5 A/s	200 / 0,5 A/s	200 / 0,5 A/s
Spark-gap extinguishing conditions	V <sub>i0</sub> < 70 V / < 20 A	< 70 V / < 20 A	< 70 V / < 20 A	< 230 V / 100 A
Insulation resistance at 10V, 100V	>1 GΩ	>1 GΩ	>1 GΩ	>1 GΩ
Self-capacitance at 1 kHz	20 pF	20 pF	20 pF	20 pF
Test category/climatic category	DIN IEC 60068-1 / 40/90/21	DIN IEC 60068-1 / 40/90/21	DIN IEC 60068-1 / 40/90/21	DIN IEC 60068-1 / 40/90/21
Relative humidity	10%...95% rh	10%...95% rh	10%...95% rh	10%...95% rh
Operating temperature range	TU -40°C ≤ T amb ≤ 80°C	-40°C ≤ T amb ≤ 80°C	-40°C ≤ T amb ≤ 80°C	-40°C ≤ T amb ≤ 80°C
Degree of protection (IEC EN 60529)	IP 67	IP 67	IP 67	IP 67
length of cable	-	300 mm	500 mm	-

### Accessories

	IF1-10-W	IF3-22-F	IF1-22-W	IF3-18-F
Article-No.	82 30 10	82 30 16	82 30 11	82 30 15



### Accessories

	K1/150	K1/300	K1/600
Article-No.	49 51 06	49 51 08	49 51 11

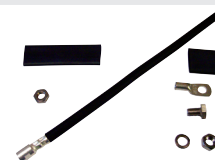

Connectors are made of hot-dip galvanized steel, with 10, 18 and 22 mm drill hole. More executions on page 218.

Connecting cable set for TC xxxA spark gaps / cable length (150, 300, 600 mm)





## Mounting: to bridge insulating flanges

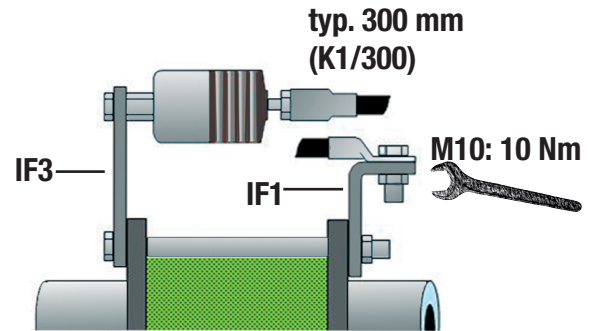
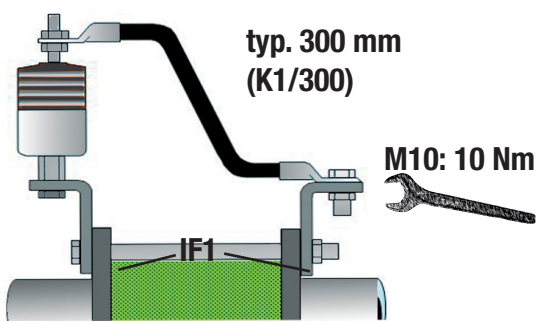

Use only tinned cable shoes or zinc plated connection parts (corrosion protection). All connections has to be safed by spring washer against shock and vibrations. For insulation parts, joint and flanges, as well as the GDT-Spark Gaps, it should not be able to be bridged by metal tools, metal parts, dirt, wast water or any current leading material.

## Application examples

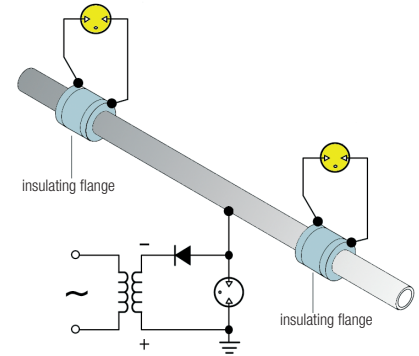
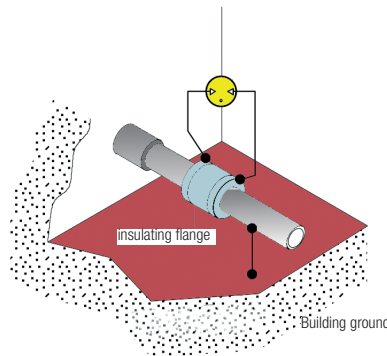
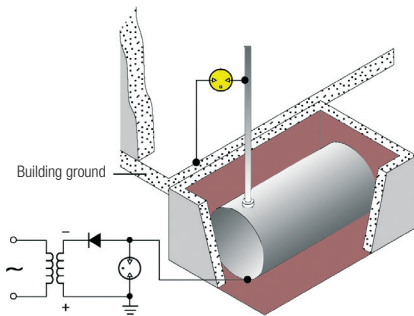

## Description

Gasfilled spark gap for using in Ex areas.

- Filled with inert gas and hermetically sealed spark gap for Lightning protection equipotential bonding acc. to DIN EN 62305/VDE 0185 in Ex areas
- For indirect lightning protective connection / grounding, of separate grounded electrical systems
- To bridge insulation joints and parts, insulation flanges etc . in cathodic protected pipe-line sections
- For safe use in Ex-zones 1+2 (ex-hazardous gases up to temperature class T4)

### Accessories for TC 100 A / TC 500 A

Article-No.	TC Acrylic hood 49 50 80
-------------	-----------------------------

Crystal clear acrylic hood for TC 100 A and TC 500 A, protects against dirt and rain outdoors.  
(Figure on the right with spark gap)





# RARE-GAS-FILLED INSULATION SPARK GAPS

## SAFETY REQUIREMENTS OF TC 100 A AND TC 500 A

### 1. Design and function of isolating spark gaps

When an overvoltage occurs, e.g. caused by lightning stroke, isolating spark gaps form a connection between earthing installations and parts of the equipment, which normally are galvanically separated. This equipotential bonding (lightning equipotential bonding, IEC/DIN EN 62305-3) reduces the potential differences caused by the lightning current.

#### 1.1 Design of isolating spark gap TC 100 A and TC 500 A

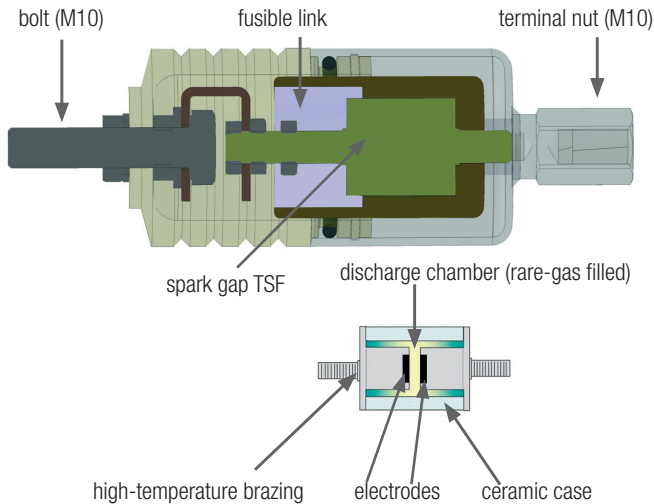

Leutron isolation spark gaps consist of intelligently designed components built from quality materials. They are manufactured with the help of vacuum technology and other special procedures. A thoroughly monitored compliance with the narrow tolerances of the metal and ceramic construction parts are essential for always stable characteristics of all Leutron products.

#### 1.2 Function

An isolation spark gap is a gas- or air-filled room enabling a discharge between two conductors (electrodes). When the potential difference between the two electrodes increases, the tension finally reaches the break-through voltage where the resulting electrical field causes the ionization of the gas within the gap. The gas becomes electrically conductive and the gap is bridged by a spark for fractions of a microsecond due to collision ionization.

The optimal choice of the rare-gas filling for the discharge chamber and the use of a well-suited expansion alloy for the electrodes are other important factors for reliability and quality.

### 2. Special features of Leutron isolating spark gaps

Rare-gas filled isolation spark gaps have properties superior to spark gaps in air. Some of the advantages are:

- Low DC and AC voltage protection level
- Significant improvement of operator protection
- Very high ignition constancy, even after stress events with impulse and AC currents
- Sparkover voltage totally independent of atmospheric air pressure and ambient humidity
- Sparkover voltage totally independent of atmospheric air pressure and ambient humidity
- Low mounting space requirements because no security distance is required

- No influence of corrosion on discharge characteristics due to rare-gas filling and high-temperature brazing
- Extremely high impulse and AC current carrying capacity
- Long service life with stable characteristics
- Double fail-safe (short-circuit) at overload and therefore continuity of protection for the installation against subsequent lightning strikes

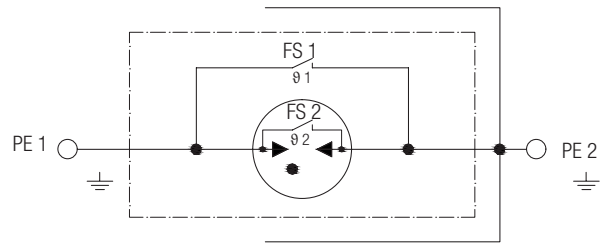

Fig.: Fail-safe 1 (FS 1) and Fail-safe 2 (FS 2) internal short-circuit

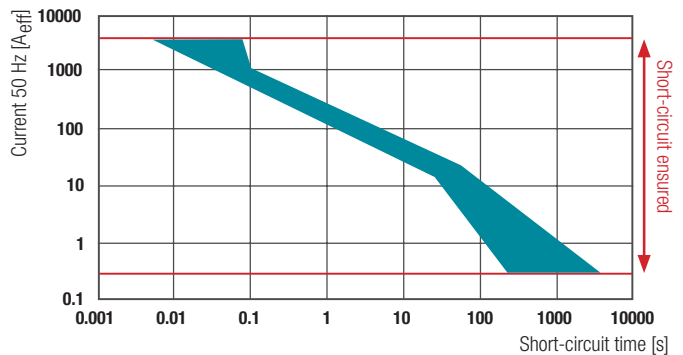

Fig.: Fail-safe temperature profile of the fusible element plotted over current/time

After triggering of the fail-safe the isolation spark gap has to be replaced.

### 3. Technical specification

#### 3.1 Mechanical properties

- Degree of protection IP 67 (dust-proof, with defined immersion)
- Dimensions (Ø x L): approx. 49 x 127 (total 160) mm
- Terminal connection: M10 bolt/nut (NIROSTA stainless steel)
- Casting compound: ARATHANE® CW 5631

#### 3.2 Electrical properties

- Lightning impulse current (10/350 µs): 75 kA
- Lightning current carrying capacity class according to EN 62561-3:2013-02
- Nominal discharge current (8/20 µs) I<sub>n</sub>: 100 kA
- 100% lightning impulse sparkover voltage: < 950 V (TC 100 A) / < 1300 V (TC 500 A)
- AC sparkover voltage (50Hz) U<sub>aw</sub>: < 70V (TC 100 A) / < 350V (TC 500 A)



### 3.3 Environment

- Operating temperature range:  $-40^{\circ}\text{C} \leq T_{\text{amb}} \leq 80^{\circ}\text{C}$
- Relative humidity: 10% ... 95% rh

### 3.4 Applied standards

- DIN EN 60079-0:2012 + A11:2013 Explosionsgefährdete Bereiche: Betriebsmittel - Allgemeine Anforderungen  
Explosive atmospheres: equipment – general requirements
- DIN EN 60079-18:2015 Explosionsgefährdete Bereiche: Geräteschutz durch Vergusskapselung „m“  
Explosive atmospheres: equipment protection by encapsulation „m“
- DIN EN 62561-3: 2013-02; VDE 0185-561-3: 2013-02 Blitzschutzsystembauteile (LPSC): Anforderungen an Trennfunkstrecken  
Lightning Protection System Components (LPSC): requirements concerning isolation spark gaps
- DIN EN 61643-11:2013-04; VDE 0675-6-11:2013-04 Überspannungsschutzgeräte für Niederspannung: Überspannungsschutzgeräte für den Einsatz in Niederspannungsanlagen - Anforderungen und Prüfungen  
Surge protective devices for low voltages: surge protective devices for application in low-voltage systems – requirements and testing

### 4. Routine tests

The isolation spark gaps TC 100 A und TC 500 A undergo a 100% electrical final testing. For the testing an automatic inspection and test unit E55B224 with a test adapter TC is used. The test unit is regularly calibrated and the calibration certifications are available.

### 5. Identification

Nameplate TC 100 A and TC 500 A:

**Trennfunkstrecke Typ TC 100 A**  
Serien-Nr. 12345-01  
Nr: 48 78 30  
U<sub>aw</sub>: 70 V I<sub>wN</sub>: 100 A  
U<sub>as</sub>: 650 V I<sub>sN</sub>: 100 kA  
 $-20^{\circ}\text{C} \leq T_{\text{amb}} \leq 80^{\circ}\text{C}$

**ZELM 02 ATEX 0095X**  
II 2 G Ex mb IIC T4 Gb

**LEUTRON GmbH**  
D-70771 Leinf.-Echterdingen, Gaußstr. 2

**Trennfunkstrecke Typ TC 500 A**  
Serien-Nr. 12345-01  
Nr: 48 78 50  
U<sub>aw</sub>: 350 V I<sub>wN</sub>: 100 A  
U<sub>as</sub>: 950 V I<sub>sN</sub>: 100 kA  
 $-20^{\circ}\text{C} \leq T_{\text{amb}} \leq 80^{\circ}\text{C}$

**ZELM 02 ATEX 0095X**  
II 2 G Ex mb IIC T4 Gb

**LEUTRON GmbH**  
D-70771 Leinf.-Echterdingen, Gaußstr. 2

### 6. Protection against explosion

#### 6.1 Zone categorization for gases and vapours (dusts):

- Zone 0 (20): Constantly over long periods or often
- Zone 1 (21): Occasional occurrence
- Zone 2 (22): normally not; otherwise, for short periods only

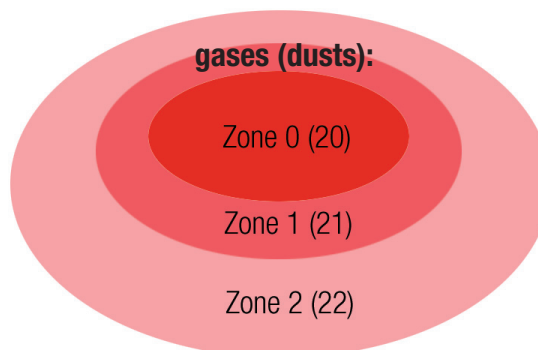

#### 6.2 Ignition protection type (gas)

Degree of protection	Sign	Zone	Device category	EN-standard
increased safety	e	1 o. 2	2 o. 3	60079-7
intrinsic safety	ia, ib, ic	0*, 1** o. 3	1*, 2**, o. 3	60079-11
over-pressure encapsulation	p	1 o. 2	2 o. 3	60079-2
oil immersion	o	1 o. 2	2 o. 3	50015
powder filling	q	1 o. 2	2 o. 3	50017
explosion-proof enclosure	d	1 o. 2	2 o. 3	60079-1
<b>casting encapsulation</b>	<b>mb</b>	<b>1 o. 2</b>	<b>2 o. 3</b>	<b>60079-18</b>
protection against ignition	n	2	3	60079-15

\* only ia, \*\* only ia and ib

#### 6.3 Encapsulation „m“ (according to IEC) for TC 100 A and TC 500 A

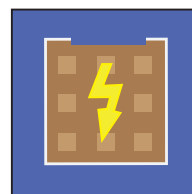

Parts which could ignite an explosive atmosphere are encapsulated in a casting compound, which prevents an ignition of the explosive atmosphere. Electrical equipment can not ignite the surrounding explosive atmosphere (neither in normal operation nor under defined abnormal operation conditions).

Main application: mb = application in zone 1 or 2

#### 6.4 Labelling according to ATEX directives of EN 60079: Gases



**II 2 G Ex mb IIC T4 Gb**

1 2 3 4 5 6 7 8

- Product group: II, according to 94/9/EG (European ATEX directive)
- Product category: 2, gases, mists, and vapours occur infrequently and for short periods only
- Gas (G)  
Part 2+3 (2 G): high protection level
- Labelling for explosion proof equipment: Ex
- Encapsulated (moulding) zone 1 or 2
- Explosion group (gas)
- Temperature class (= 135°C)
- Equipment protection level Gb (EPL gas: high)



## Connectors IF-W and IF-F

Connectors IF3 and IF1 are made of hot-dip galvanized steel, elongate (-F) or angulate (-W) with different drill hole cross section dimension.

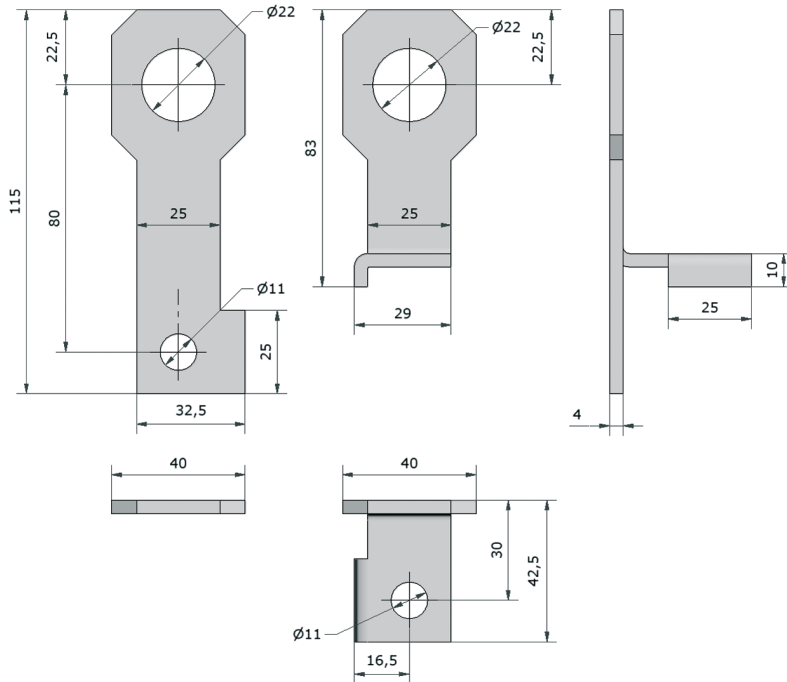
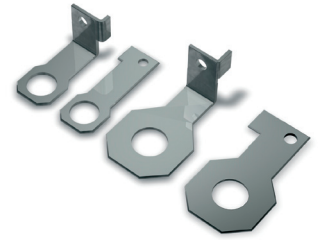

Dimension IF1-22-W and IF3-22-F

Article-No.	Product name	Description
49 51 18	IF3-30-F	Connectors are made of hot-dip galvanized steel, elongate with 30 mm Drill hole
49 51 19	IF1-30-W	Connectors are made of hot-dip galvanized steel, angulate with 30 mm Drill hole
82 30 10	IF1-10-W	Connectors are made of hot-dip galvanized steel, angulate with 10 mm Drill hole
82 30 11	IF1-22-W	Connectors are made of hot-dip galvanized steel, angulate with 22 mm Drill hole
82 30 12	IF1-16-W	Connectors are made of hot-dip galvanized steel, angulate with 16 mm Drill hole
82 30 15	IF3-18-F	Connectors are made of hot-dip galvanized steel, elongate with 18 mm Drill hole
82 30 16	IF3-22-F	Connectors are made of hot-dip galvanized steel, elongate with 22 mm Drill hole
82 30 17	IF3-16-F	Connectors are made of hot-dip galvanized steel, elongate with 16 mm Drill hole
82 30 18	IF3-25-F	Connectors are made of hot-dip galvanized steel, elongate with 25 mm Drill hole
82 30 19	IF1-23-W	Connectors are made of hot-dip galvanized steel, angulate with 23 mm Drill hole
82 30 20	IF1-18-W	Connectors are made of hot-dip galvanized steel, angulate with 18 mm Drill hole
82 30 21	IF1-42-W	Connectors are made of hot-dip galvanized steel, angulate with 42 mm Drill hole
82 30 22	IF1-52-W	Connectors are made of hot-dip galvanized steel, angulate with 52 mm Drill hole
82 30 24	IF1-19.8-W	Connectors are made of hot-dip galvanized steel, angulate with 19,8 mm Drill hole
82 30 25	IF1-22.2-W	Connectors are made of hot-dip galvanized steel, angulate with 22,2 mm Drill hole
82 30 26	IF1-28.6-W	Connectors are made of hot-dip galvanized steel, angulate with 28,6 mm Drill hole
82 30 27	IF1-32-W	Connectors are made of hot-dip galvanized steel, angulate with 32 mm Drill hole
82 30 28	IF1-39-W	Connectors are made of hot-dip galvanized steel, angulate with 39 mm Drill hole

## TSF for DIN rail

Rare-gas-filled spark gap for the lightning protection equipotential bonding, the insulation of electrically separated parts and the bridging of insulating flanges of gas pipelines.



example image

- AC spark-over voltage : 70 V
- DC spark-over voltage : 100 V bzw. 500 V
- DC-Impulse sparkover voltage (1 kV/μs): 650 V
- Light. imp. current resistance (10/350 μs): 100 kA
- Mounting on 35 mm DIN rail (EN 60715)
- Test standard DIN EN 62561-3
- Degree of protection (IEC EN 60529): IP 20
- Inflammability class according to UL 94 V0
- EAC certificated

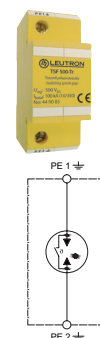
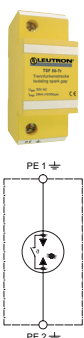
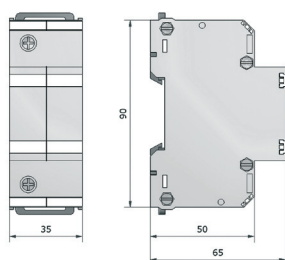

### Technical Data

Product name	TSF 50-Tr	TSF 100-Tr	TSF 500-Tr
Article-No.	44 90 76	44 90 80	44 90 85
IEC category	Class 1L	Class H	Class H
Nominal DC sparkover voltage at 100V/s	U <sub>agN</sub> -	100 ±20% V=	500 ±20% V=
Nominal AC sparkover voltage (50 Hz)	U <sub>aw</sub> 50 ±20% V	70 ±20% V	350 ±20% V
Typ. Impulse sparkover voltage	U <sub>as</sub> -	650 V	950 V
Max. Impulse sparkover voltage	U <sub>as</sub> -	950 V	1300 V
Lightning impulse current (10/350 μs) total	I <sub>total</sub> 25 kA	100 kA	100 kA
Nominal impulse discharge current (10 x 8/20 μs)	I <sub>n</sub> 25 kA	100 kA	100 kA
5x Nominal alternating discharge current at 50Hz, 1s, 3min pause	I <sub>wn</sub> -	100/1 Aeff/s	100/1 Aeff/s
Nominal alternating discharge current (50 Hz)	-	200 / 0,5 A/s	200 / 0,5 A/s
Alternating current critical load (50 Hz) (1x 0.3s)	I <sub>wgr</sub> -	4.000 / 0,25 Aeff/s	4.000 / 0,25 Aeff/s
Spark-gap extinguishing conditions	V <sub>lö</sub> -	<70 V / < 20A	< 230 V / < 100 A
Insulation resistance at 10V, 100V	≥ 1 GΩ	≥ 1 GΩ	≥ 1 GΩ
Self-capacitance at 1 kHz	6 pF	6 pF	4 pF
Test category/climatic category	DIN IEC 60068-1 / 40/90/21	DIN IEC 60068-1 / 40/90/21	DIN IEC 60068-1 / 40/90/21
Relative humidity	10%...95% rh	10%...95% rh	10%-95% rh
Operating temperature range	TU -40 - +80 °C	-40 - +80 °C	-40 - +80 °C
Max. conductor cross section	50mm <sup>2</sup> stranded/35mm <sup>2</sup> flexible	50mm <sup>2</sup> stranded/35mm <sup>2</sup> flexible	50mm <sup>2</sup> stranded/35mm <sup>2</sup> flexible



# RARE-GAS-FILLED INSULATION SPARK GAPS DIN RAIL MOUNTING

## TF for DIN rail

Protects measuring transformers; lightning and surge voltage protector for 1A respectively 5A cores in current transformers.



example image

- Very high impulse and AC current resistivity
- No blow-out vents, thus, not requiring any safety clearance to other installations
- High insulation resistance Risol: > 1 GΩ
- Very long service life
- Test standard DIN EN 62561-3
- Remote signal contact (PK): closer
- Inflammability class according to UL 94 V0
- EAC certificated

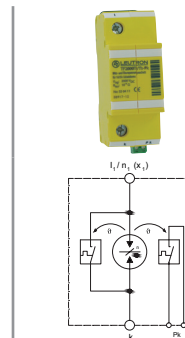
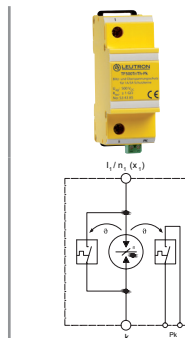
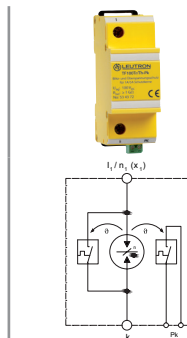
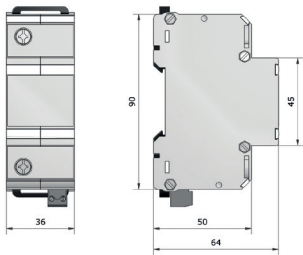

### Technical Data

Product name		TF 100Tr/Th-Pk	TF 500Tr/Th-Pk	TF 2000Tr/Th-Pk
Article-No.		53 43 72	53 43 85	55 04 11
DC spark-over voltage (100V/s)	U <sub>ag</sub>	100 ±20% V=	500 ±20% V=	2000 (-10% / +20%) V=
AC spark-over voltage (100V/s) (50/60Hz)	U <sub>aw</sub>	70 ±20% V~	350 ±20% V~	1414 (-10%/ +20%) V~
Impulse sparkover voltage typ. at 1 kV/μs	U <sub>as</sub>	typ. 650 / max. 900 V=	typ. 1000 / max. 1300 V=	< 3.000 V=
Impulse sparkover voltage at 1 kV/ns (100 MHz)	U <sub>as</sub>	typ. 1600 / max. 1900 V	typ. 2800 / max. 3000 V	-
Capacitance	C	≤ 18 pF	≤ 16 pF	≤ 16 pF
Insulation resistance at 10 V	R <sub>is</sub>	≥ 1 GΩ	≥ 1 GΩ	≥ 1 GΩ
Nominal impulse discharge current (8/20 μs)	I <sub>n</sub>	10x 100 kA	10x 100 kA	10 x 60 kA
Lightning impulse current (10/350 μs) (I <sub>imp</sub> ) + long-time current 200 A/0.5 s/100 As	I <sub>peak</sub> / Q / W/R	1x 100 kA / 50 As / 2500 kJ/Ω	1x 100 kA / 50 As / 2500 kJ/Ω	1x 60 kA / 30 As / 900 kJ/Ω
Lightning impulse current I <sub>imp</sub> (10/45 μs)+half-wave 1.6 kA (DIN 48810)	I <sub>peak</sub> / Q / W/R	20x 60 kA /10 As /100 kJ/Ω	20x 60 kA /10 As /100 kJ/Ω	20x 60 kA /10 As /100 kJ/Ω
5x Nominal alternating discharge current at 50Hz, 1s, 3min pause	I <sub>wn</sub>	100 A <sub>eff</sub>	100 A <sub>eff</sub>	100 A <sub>eff</sub>
Operating temperature range	TU	-40 - +75 °C	-40 - +75 °C	-40 - +75 °C
Recommended conductor cross section		25 mm <sup>2</sup>	25 mm <sup>2</sup>	25 mm <sup>2</sup>
Max. conductor cross section		50mm <sup>2</sup> stranded/35mm <sup>2</sup> flexible	50mm <sup>2</sup> stranded/35mm <sup>2</sup> flexible	50mm <sup>2</sup> stranded/35mm <sup>2</sup> flexible
Max. connection torque for terminals		4,0 Nm	4,0 Nm	4,0 Nm
Max. conductor cross section Pk		1,5 mm <sup>2</sup>	1,5 mm <sup>2</sup>	1,5 mm <sup>2</sup>
Switching capacity Pk		250 V/2 A	250 V/2 A	250 V/2 A
Degree of protection (IEC EN 60529)		IP 20	IP 20	IP 20

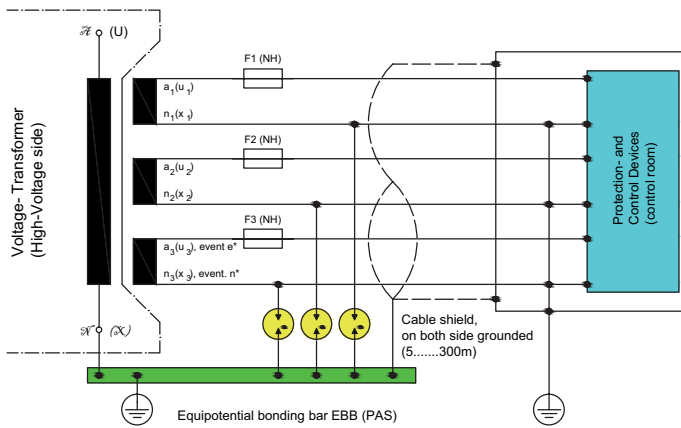

## High-Voltage (HV) – Voltage-Transformer

The earth of voltage transformers, separated from the secondary coils must be bridged by isolating spark saps, to guarantee the equipotential bonding in case of lightning strokes. By that a danger spark-over at the isolation of the measuring circuit and a destroy of the measuring circuit is avoided.

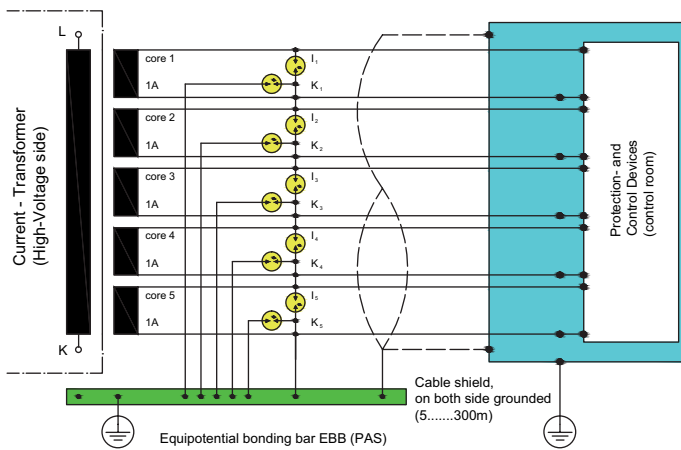

## High-Voltage (HV) and Medium-Voltage (MV) Current-Transformer

At current transformers the protection against lightning as well as the protection of the cores in case of an unexpected no-load working condition must be guaranteed. The suitable type of the isolating spark saps must be selected according to the size of the current transformer. LEUTRON has three kind of hermetical sealed spark gaps filled with inert-gas available which suit to transformers of different size.

These gas-filled and hermetically-sealed spark gaps protect the cores of current transformers in the event of overvoltages caused by open secondary circuit, lightning and switching operations in HV and MV networks. The overvoltages are restricted to a non-dangerous level and impulse currents discharged. This provides reliable protection without disturbing the normal operation of the transformer.

## SMALLER, MORE COMPACT AND MOST EFFICIENT

Extended metal structures like gas pipelines are endangered by induced AC voltages from high-voltage overhead lines and suchlike. These voltages can cause corrosion and pitting and, therefore, have to be diverted. Leutron's PLPro is the most compact and, at the same time, most robust solution available for such problems.

**The application of Leutron's worldwide tried and tested technology saves time and money.**



## PROTECTION OF OUTDOOR INSTALLATIONS:

- Monitoring possible by remote measurement of the current flow
- Lightning current carrying capacity up to lightning protection level LPL 1
- No interference with detection signals on pipelines
- Cascadable, i.e., adaptable to the value of the current to divert
- Reliable diversion of harmful AC voltages in metal structures







Leutron's protective devices are maintenance-free due to enclosed arresters

## **PIPELINE PROTECTION DEVICES FOR AC APPLICATION**

# AC CURRENT DIVERTER FOR 80 A FOR THE PROTECTION OF CATHODIC CORROSION PROTECTION SYSTEMS (CCPS) OF PIPELINES

- High discharge capacity up to 100 kA (10/350  $\mu$ s), class H
- Low sparkover voltage

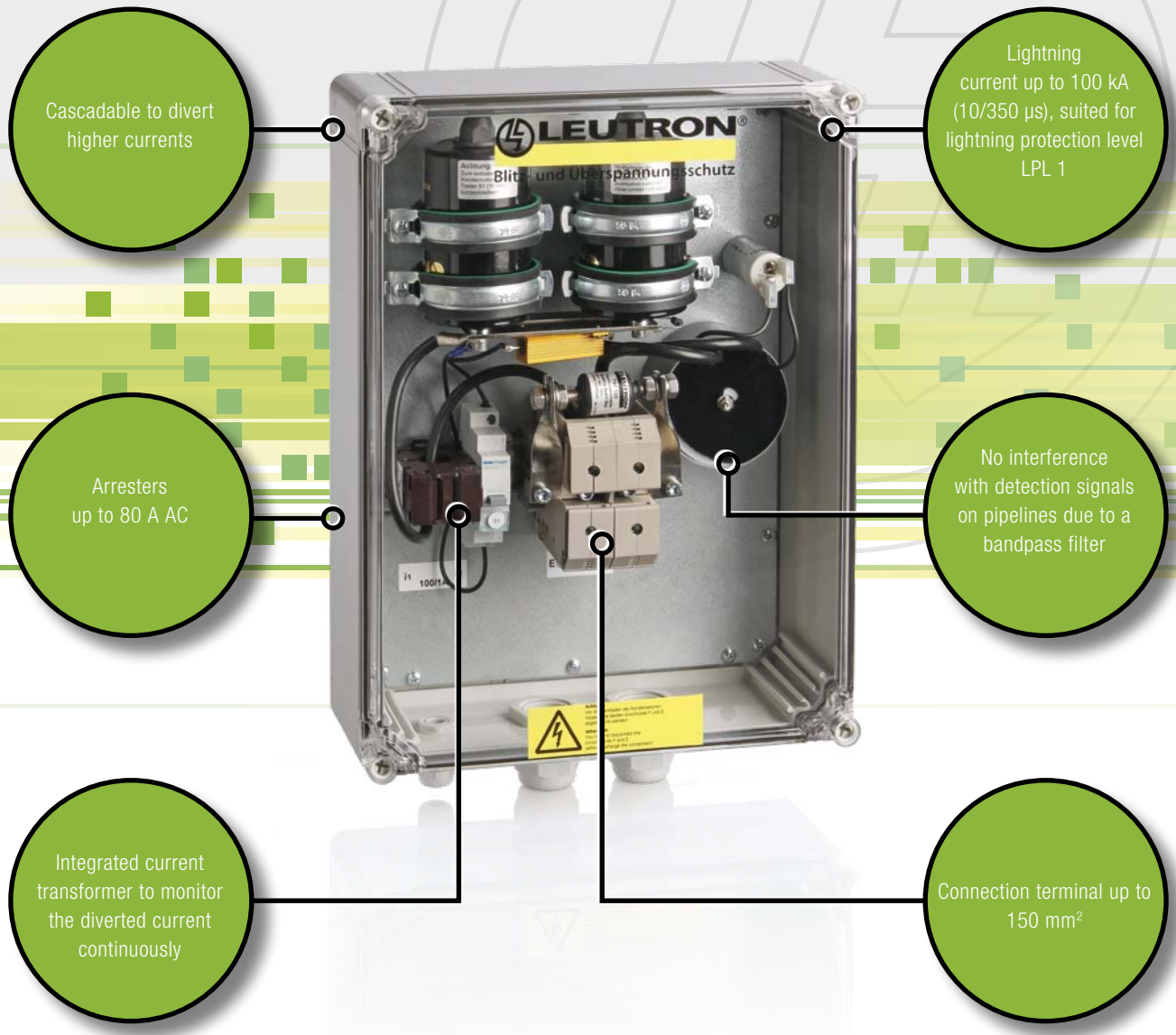

Cascadable to divert higher currents

Arresters up to 80 A AC

Integrated current transformer to monitor the diverted current continuously

Lightning current up to 100 kA (10/350  $\mu$ s), suited for lightning protection level LPL 1

No interference with detection signals on pipelines due to a bandpass filter

Connection terminal up to 150 mm<sup>2</sup>



**REFERENCE: V&C KATHODISCHER  
KORROSIONSSCHUTZ GES.M.B.H., AUSTRIA**

»For a number of years we now use Leutron's PLPro system to divert alternating currents. The systems installed so far operate smoothly, and we never received any complaints from customers. At the insulating flanges of our cathodic corrosion protection systems we very often apply ATEX certified isolation spark gaps TC 100 A. They too work to the satisfaction of our customers. So far no malfunction or break-down occurred.«





### Total Package for Pipeline Protection

In order to protect CCP systems against the effects of lightning strokes and overloads by induced ac currents it is necessary to provide an effective protection. This is possible by installing an combined arrester type 1+2+3 (e.g. CT-T1+2+3/3+1-350-FM) at the ac power supply side of the CCPS and the EnerPro 65V/12A-Tr plus a DataPro2x1-RLC/50V-Tr on the dc side.

The pipeline has to be divided into sections by applying insulating flanges (joints) or insulating parts at pipelines with a narrow diameter. These sections limit the range of influence of the CCPS.

In case of a lightning stroke to the area, the insulating flange has to be bridged to prevent a potential difference that may result in an electrical flashover and, thus, damage to the inside or outside pipeline insulation. This equipotential bonding is achieved by applying special lightning current resistant, hermetically sealed high-performance isolating spark gaps (100 kA, 10/350 µs) filled with rare gas. Their fail-safe behaviour impedes mechanical damage at overloads.

Due to the bridged insulating flanges the pipeline, at a lightning stroke, acts like an earthing conductor. At certain distances an earthing point has to be set up, either at a pumping station or between them. In the latter case two isolation spark gaps are mandatory at the insulating flange, as mentioned above (5).

If the pipeline runs in parallel with overhead lines or ac cable systems, alternating currents are induced in the pipeline impeding the proper function of the CCPS and causing ac cathodic corrosion. The ac current diverter PLPro 40A-iV prevents this by diverting the induced alternating currents to ground while blocking the direct currents of the CCPS. Therefore, the CCPS continues to stay in effect.



Buried natural gas pipelines as well as drinking-water pipeline are protected with CCP systems.

Leutron makes sure that cathodic corrosion protection systems work properly and, thus, corrosion is given no chance.



The PLPro 40A-IV is effectively and steadily protected against direct lightning strokes by an isolation spark gap TSF 100 (or TC 100 A in hazardous areas) with 100 kA (10/350 µs). An integrated current transformer measures the diverted alternating current.

Pipelines that transport hazardous mediums like natural gas and run in a duct above or below ground have to be protected with ATEX-certified spark gaps with a low sparkover voltage (70 V ac / 100 V dc) (4) and fail-safe function. In case of direct-buried pipelines no ATEX certification of the isolation spark gap is necessary. Hence, the waterproof isolation spark gap SGO 70/100 QA is the preferred choice.

An HF filter, included as well, ensures an efficient operation and blocks the 10 kHz detection signal of HF leakage detectors. The amply dimensioned long-life power capacitors are additionally protected by fine-protection diodes.



Protection of a rectifier substation (LAF Brachwitz)

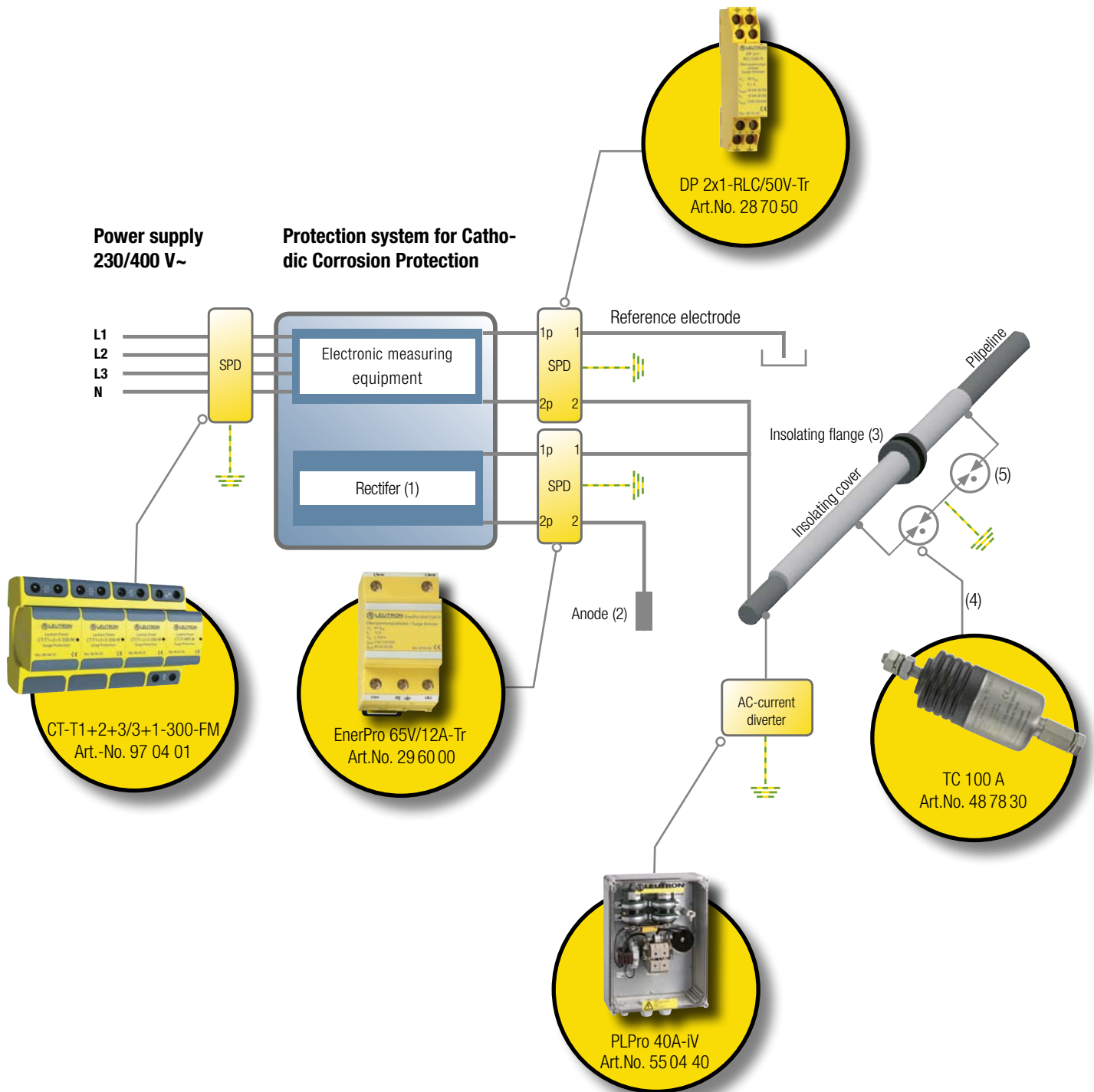

#### Properties of PLPro:

- Integrated lightning and surge current protection up to 100 kA (10/350  $\mu$ s)
- High impulse discharge current
- Safety switch for discharging the capacitors
- Does not have to be disconnected during leakage detection with HF detector (10 kHz)
- Can be mounted in a weather-proof outdoor cabinet or box without further protection measures
- Built-in measuring circuit with analogue display for ac discharge current
- No danger for operating personnel
- Maintenance-free

#### In general, PLPro consists of five components:

- AC discharge unit, consisting of high-performance capacities (2 pieces per 40 A)
- Surge protection device (fine protection) for the capacitors
- Measurement of the discharge current 100/1 A, AC current transformer, indicating instrument (on request)
- 10 kHz band-elimination filter which prevents the diversion of the 10 kHz search frequency of the leakage detectors against earth
- Lightning protection (coarse protection) by rare-gas-filled isolating spark gap 100 kA (10/350  $\mu$ s) with low sparkover voltage



# PROTECTIVE DEVICES FOR AC APPLICATION

## TABLE OF CONTENTS

Protective devices for AC application		Page
<b>AC-current diverter up to AC 80A</b>		<b>229</b>
PLPro-iV	Protection against the electrochemical process of corrosion	229
<b>Arresters for Cathodic Corrosion Protection Systems</b>		<b>230</b>
EnerPro CV 2P xxV/63A-(LED)	2 pole arrester 63 A, variations 35V and 100 V, partially with LED control	230
EnerPro 65V/12A-Tr	2 pole SPD for operating current up to 12 A	231
EnerPro 65V/20A-Tr	2 pole SPD for operating current up to 20 A	231



### PLPro-iV

With an active cathodic corrosion protection the installation is permanently protected against the electrochemical process of corrosion. For that matter a grid supplied rectifier is inserted between the installation (e.g. a pipeline) and an anode that serves as earth electrode.



- AC discharge current: 40 or 80 A
- Several PLPro devices can be connected in parallel to raise the total discharge current
- Maintenance-free
- No disturbance of search signals
- Monitoring of discharge current with integrated current transformer possible
- Integrated lightning and surge current protection up to 100 kA (10/350  $\mu$ s)
- Safety switch for discharging the capacitors
- execution with HSCS-500-FM: PLPro-40A-iV HSCS-500-FM, with remote signalling contact; Technical data of HSCS see page 213

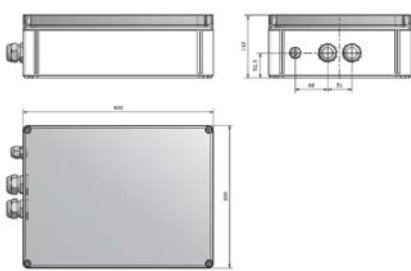

1)



2)



3)

#### Technical Data

Product name	PLPro-40A-iV	PLPro-80A-iV	PLPro-40A-iV HSCS-500-FM
Artical-No.	55 04 40	55 04 41	55 04 39
Rated voltage (P-E)	U <sub>max</sub> 25 V=	25 V=	25 V=
Max. continuous diverting current 50Hz (P-E)	I <sub>A</sub> 40 A~	80 A~	40 A~
Short-time discharge current for 1s/50Hz (P-E)	I <sub>max</sub> 400 A~	400 A~	400 A~
Leakage current (P-E)	≤ 1 mA	≤ 1 mA	≤ 1 mA
Nominal discharge current (8/20 $\mu$ s) (P-E)	I <sub>n</sub> 10x 100 kA	10x 100 kA	10x 100 kA
Lightning impulse current (10/350 $\mu$ s)	I <sub>imp</sub> 100 kA	100 kA	100 kA
Operating temperature range	T <sub>U</sub> -40 - +80 °C	-40 - +80 °C	-40 - +80 °C
Terminals (P/E)	min. 16 / max. 150 mm <sup>2</sup>	min. 16/max. 150 mm <sup>2</sup>	min. 16 / max. 150 mm <sup>2</sup>
Current transformer	100:1 A	100:1 A	100:1 A
Terminals (Current transformer i1, i2)	25 mm <sup>2</sup>	max. 2,5 mm <sup>2</sup>	25 mm <sup>2</sup>
Mounting	Wall mounting	Wall mounting	Wall mounting
Dimensions (L x W x H)	400 x 300 x 132 mm	600 x 400 x 132 mm	400 x 300 x 132 mm
Degree of protection (IEC EN 60529)	IP 65	IP 65	IP 65
Capacitance	C 2x 100.000 $\mu$ F	2x 200.000 $\mu$ F	2x 100.000 $\mu$ F

#### Basic circuit diagram:

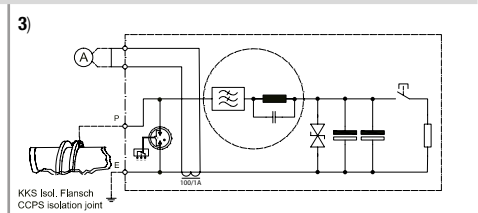
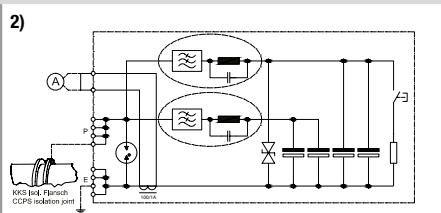
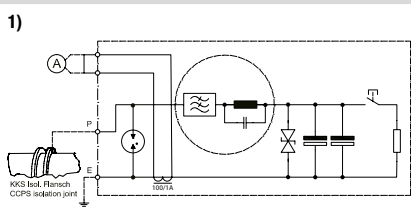



# PROTECTIVE DEVICES FOR AC APPLICATION

## ARRESTERS FOR CATHODIC CORROSION PROTECTION SYSTEMS

### EnerPro CV 2P xxV/63A-(LED)

These devices are predominantly used for cathodic corrosion protection systems at gas and oil pipelines with bitumen insulation layer.



- Mounting directly on DIN rail
- Operating current up to 63 A
- Version with and without LED available
- Leakage current-free

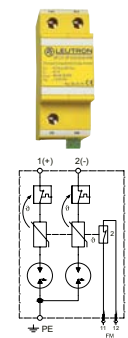
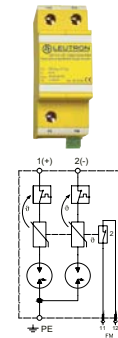
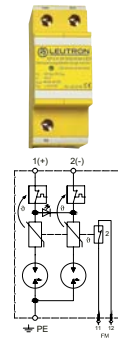
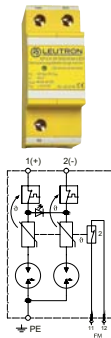
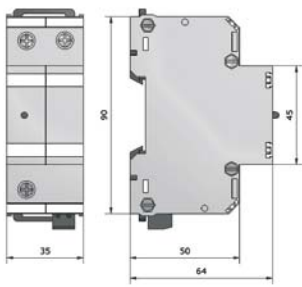

#### Technical Data

Product name	EP CV 2P 65V/63A/FM-LED	EP CV 2P 100V/63A-FM-LED	EP CV 2P 100V/63A/FM	EP CV 2P 65V/63A/FM
Artical-No.	38 20 83	38 20 87	38 20 89	38 20 79
IEC category	Type 2 / class II	Type 2 / class II	Type 2 / class II	Type 2 / class II
Nominal voltage DC	UN 36 V=	100 V=	100 V=	36 V=
Nominal voltage AC	UN 30 V~	75 V~	75 V~	30 V~
Max. continuous operating voltage DC	Uc 65 V=	125 V=	125 V=	65 V=
Max. continuous operating voltage AC	Uc 45 V~	95 V~	95 V~	45 V~
Max. acceptable fuse or back-up fuse	63 A gL/gG	63 A gL/gG	63 A gL/gG	63 A gL/gG
Protection level (1kV/μs)	Up ≤ 0,55 kV	≤ 0,6 kV	≤ 0,6 kV	≤ 0,55 kV
Protection level at 1kV/μs (1,2-PE)	Uas ≤ 0,55 kV	≤ 0,6 kV	≤ 0,6 kV	≤ 0,55 kV
Response time	tA 50 ns	50 ns	50 ns	50 ns
Nominal discharge current (8/20 μs)	In 20 kA	20 kA	20 kA	20 kA
Max. impulse discharge current (8/20 μs)	Imax 40 kA	25 kA	25 kA	40 kA
Lightning impulse current (10/350 μs) per pole	Iimp 5 (2,5 As) kA	5 kA	5 kA	5 (2,5 As) kA
Operating temperature range	TU -40 - +80 °C	-40 - +80 °C	-40 - +80 °C	-40 - +80 °C
Max. conductor cross section	50mm <sup>2</sup> stranded/35mm <sup>2</sup> flexible	50mm <sup>2</sup> stranded/35mm <sup>2</sup> flexible	50mm <sup>2</sup> stranded/35mm <sup>2</sup> flexible	50mm <sup>2</sup> stranded/35mm <sup>2</sup> flexible
Max. connection torque for terminals	4,0 Nm	4,0 Nm	4,0 Nm	4,0 Nm
Enclosure material / colour	polycarbonate UL 94-V0 / yellow	polycarbonate UL 94-V0 / yellow	polycarbonate UL 94-V0 / yellow	polycarbonate UL 94-V0 / yellow
Degree of protection (IEC EN 60529)	IP 20	IP 20	IP 20	IP 20
Switching capacity	250 V/2 A	250 V/2 A	250 V/2 A	250 V/2 A
Max. conductor cross section FM	1,5 mm <sup>2</sup>	1,5 mm <sup>2</sup>	1,5 mm <sup>2</sup>	1,5 mm <sup>2</sup>



## EnerPro 65V/12A-Tr

Two-pole surge arrester for operating currents up to 12 A and a nominal impulse discharge current of 20 kA (8/20  $\mu$ s) for sensitive electronic devices.

- Two-stage design
- High performance surge protector
- Rated load current 12 A
- Maximum acceptable DC continuous operating voltage of 65 V DC
- With filter
- With remote signalling contact (FM)

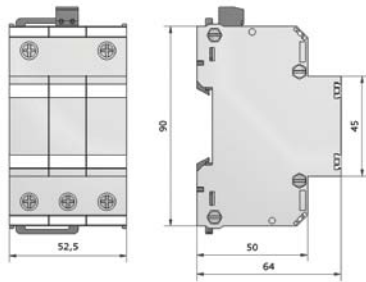
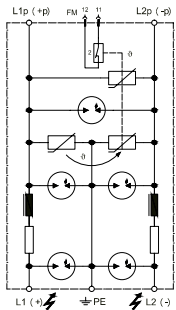

### Technical Data

Product name		EnerPro 65V/12A-Tr/FM
Artical-No.		29 60 02
Max. continuous operating voltage DC	Uc	65 V=
Rated load current	IL	12 A
Protection level at 1kV/ $\mu$ s	Up	$\leq$ 350 V
Nominal discharge current (8/20 $\mu$ s)	In	20 kA
Max. impulse discharge current (8/20 $\mu$ s)	I <sub>max</sub>	40 kA
Lightning impulse current (10/350 $\mu$ s)	I <sub>imp</sub>	5 (2,5 As) kA
Nominal alternating discharge current (50 Hz)		20 (5x1s, 50Hz, 3min. Pause) A
Response time	tA	$\leq$ 25 ns
Max. conductor cross section		stranded 35/fine stranded 25 mm <sup>2</sup>
Max. connection torque for terminals		4,0 Nm
Operating temperature range	TU	-40 - +80 °C
Enclosure material / colour		polycarbonate UL 94-V0 / yellow
Degree of protection (IEC EN 60529)		IP 20
Mounting on		35 mm DIN rail (EN 60715)
FM contact / contact type		break contact
Switching capacity		250 V/2 A
Max. conductor cross section FM		1,5 mm <sup>2</sup>

## EnerPro 65V/20A-Tr

Two-pole surge arrester for operating currents up to 20 A and a nominal impulse discharge current of 20 kA (8/20  $\mu$ s) for sensitive electronic devices.

- Two-stage design
- High performance surge protector
- Rated load current 20 A
- Maximum acceptable DC continuous operating voltage of 65 V DC
- With filter
- With remote signalling contact (FM)

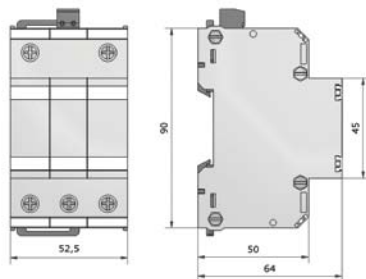
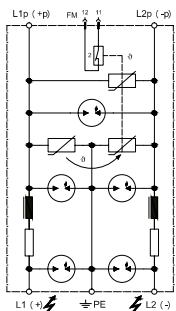

### Technical Data

Product name		EnerPro 65V/20A-Tr/FM
Artical-No.		29 60 11
Max. continuous operating voltage DC	Uc	65 V=
Rated load current	IL	20 A
Protection level at 1kV/ $\mu$ s	Up	$\leq$ 350 V
Nominal discharge current (8/20 $\mu$ s)	In	20 kA
Response time	tA	$\leq$ 25 ns
Max. impulse discharge current (8/20 $\mu$ s)	I <sub>max</sub>	40 kA
Lightning impulse current (10/350 $\mu$ s)	I <sub>imp</sub>	5 (2,5 As) kA
Nominal alternating discharge current (50 Hz)		20 (5x1s, 50Hz, 3min Pause) A
Operating temperature range	TU	-40 - +80 °C
Max. conductor cross section		stranded 35/fine stranded 25 mm <sup>2</sup>
Max. connection torque for terminals		4,0 Nm
Enclosure material / colour		polycarbonate UL 94-V0 / yellow
Degree of protection (IEC EN 60529)		IP 20
Mounting on		35 mm DIN rail (EN 60715)
FM contact / contact type		break contact
Switching capacity		250 V/2 A
Max. conductor cross section FM		1,5 mm <sup>2</sup>

## LEUTRON PROTECTS THE FUTURE

Because photovoltaic systems (among other things) are the future. Whether for new buildings or for renovations, for private residences or for office buildings: these systems are being installed on more and more roofs across the world.

In addition to the modules, the photovoltaic system is also integrated into the building's electrical systems, which are necessarily vulnerable to direct or indirect lightning strikes.

Lightning strikes and power surges have serious consequences: aside from production losses, there are also high repair costs - Costs that Leutron can keep down.



## LEUTRON PROTECTS PHOTOVOLTAIC SYSTEMS UP TO 1000 V DC

- External lightning protection
- Use und dimensioning of Surge Protective Devices

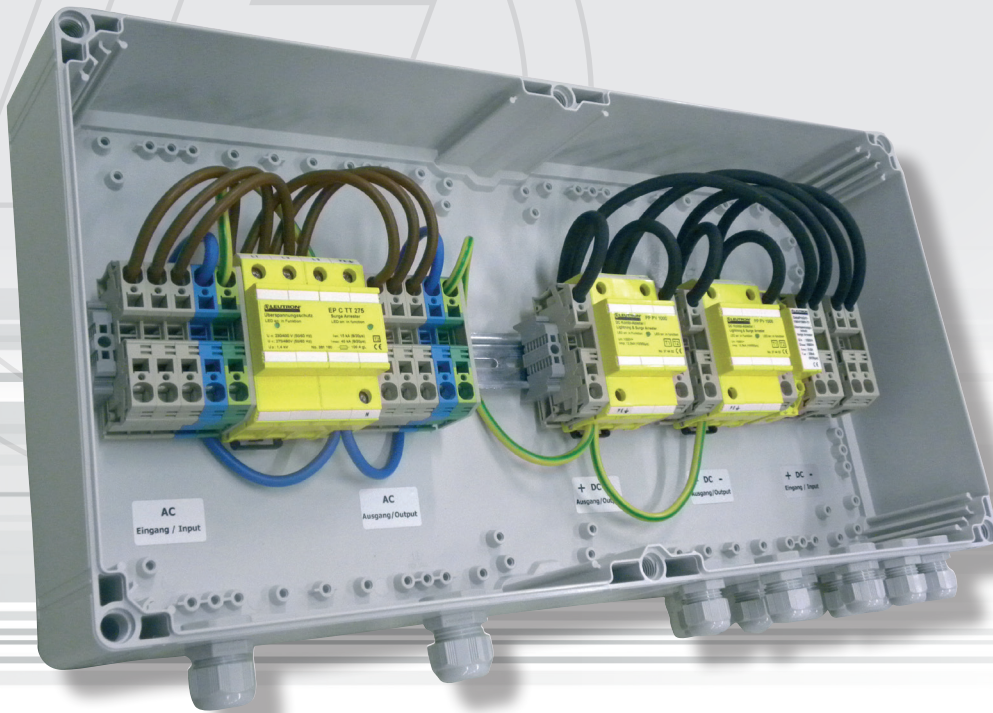

High-quality protection devices for Photovoltaic systems:  
Generator Connection Box with Surge Protection Devices

## **SURGE PROTECTION OF PV SYSTEMS**

## ALL-ROUND PROTECTION WITH GENERATOR CONNECTION BOXES

- Efficient installation: Several strings of the PV arrangement are brought together in one point
- Cable installation without effort
- Realization of projects are flexible, safe and economical
- Thanks of SPD type 1+2 (class I+II) effective surge protection is real
- EAC certificated

High-quality  
Components

Through terminals  
max. 16 mm<sup>2</sup>

Cables inlet bottom

EAC certificated

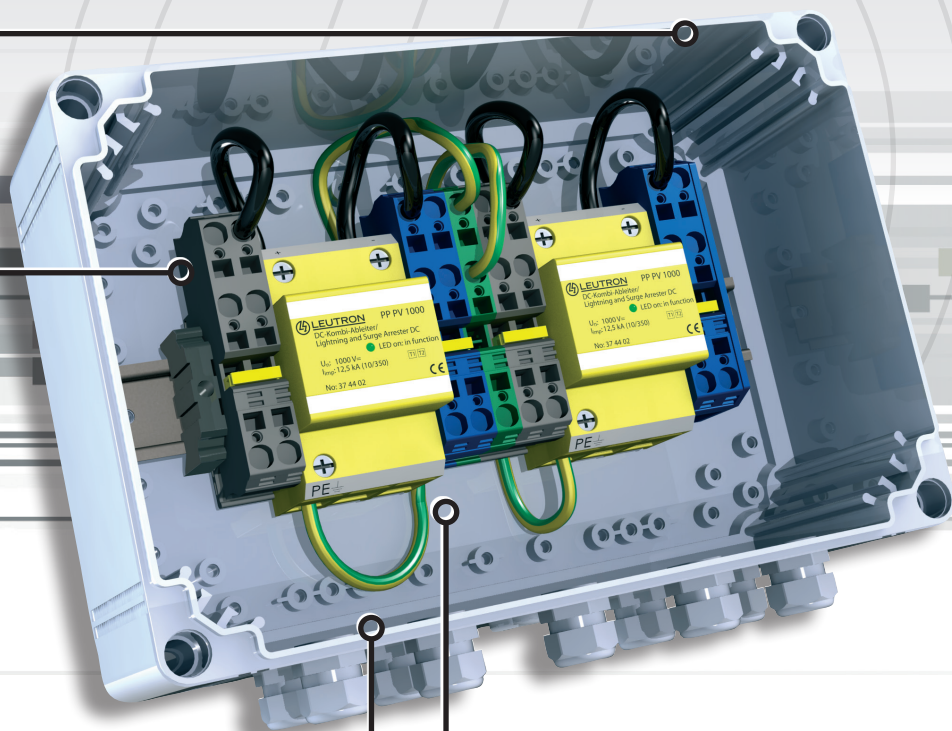

## SELECTION GENERATOR CONNECTION BOXES

- Open-circuit voltage of the strings
- Number of the strings
- Number of the MPP tracker



## CHARACTERISTICS OF GENERATOR CONNECTION BOXES

- For DC or DC/AC installations
- With or without remote monitoring
- For the use with string fuses and string diodes
- For outdoor installation
- UV resistance
- Protection class II

DC and AC side  
protected in only one  
stable housing

AC-SPD

DC-SPD Type 1+2

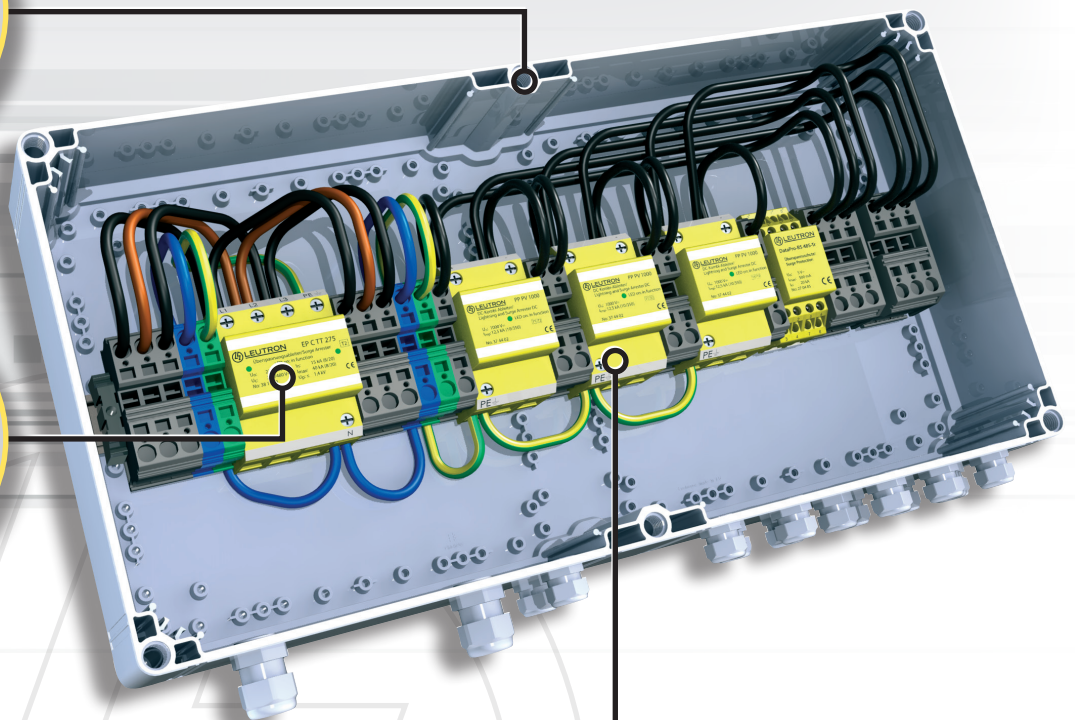



# GENERATOR CONNECTION BOXES

## TABLE OF CONTENTS

<b>Generator Connection Box (GAK)</b>		<b>Page</b>
<b>Generator Connection Box without strand fuses</b>		<b>237</b>
GAK 2+2	GAK with each 2 SPDs type 2 or type 1+2, 800 or 1000 V PV voltage	237
GAK 3x1 / GAK 6x1 / GAK 8x2 / GAK 9x1	GAK with 3 up to 9 SPD type 2 or type 1+2, 800 or 1000 V PV voltage	238
<b>Generator Connection Box with reverse current fuse</b>		<b>239</b>
GAK x2 T1+T2 1000V-DSK	per arrester on both side each 2 fuse holder for minus- and pluspole	239
GAK x3 T1+T2 1000V-DSK	per arrester on both side each 3 fuse holder for minus- and pluspole	240
GAK 2x5 T1+T2 1000V-DSK	Input / Output: parallel circuit 5 Strings in, 5 Strings out	241
GAK 5x1 T1+T2 1000V	GAK with five DC combined arrester type 1+2 with 1000 Volt, for five MPP tracker	241
GAK 1x T1+T2 1000V	GAK with one DC combined arrester type 1+2 with 1000 Volt, for one MPP tracker	242
GAK 2x T1+T2 1000V	GAK with two DC combined arrester type 1+2 with 1000 Volt, for two MPP tracker	243
<b>Complete protection of inverter</b>		<b>244</b>
PV AC-DC	For one or more strings, with one or three phase AC systems	244
<b>Protection of inverter rectifier AC-side</b>		<b>245</b>
GAK AC	GAK for three phase TNS systems, e. g. at PV systems to protect the AC part of the inverter	245
<b>Special executions of GAK</b>		<b>245</b>
PV DC 1/1	To protect the inverter with one MPP tracker	245
Fuse Combiner Box	Protection of battery systems in PV systems	246
GAK 2x2 Zw	To take strings together on their way to the inverter rectifier	246
PV Connection Boxes	With SPD type 2 in IP 65 housing	247
<b>Accessories GAK</b>		<b>248</b>
String fuses	String fuses with rated current of 2 up to 20 Ampere	248
DAK 2x 16	Double connection for looped-in wiring	248
E-Membran M12	Air-rating plug with membran for ventilation	248



## GAK 2+2



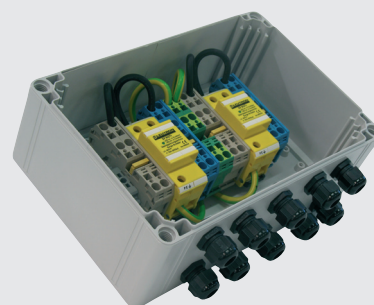

Generator connection box for maximum 2x five terminal points for two MPP tracker. Application: to protect inverter with two MPP trackers or two inverter with each one MPP tracker.

The technical connection conditions of the inverter manufacturer are to be observed! If several module strings are connected in parallel, the instructions of the module manufacturer regarding reverse current resistance must be observed.



example image

- Housing of surface mounting (300 x 200 x 132 mm) is UV resistant
- 2x 5 terminal points (e. g. 2x 2 input terminals and 2x 2 output terminals)
- Two surge arrester included
- Terminals can be used as points of measurement
- EAC certification
- With remote signalling contact (FM)
- Degree of protection (IEC EN 60529): IP66

Technical Data					
<b>Product name</b>		<b>GAK 2+2/2+2/2xT2 800V-FM</b>	<b>GAK 2+2/2+2/2xT2 1000V-FM</b>	<b>GAK 2+2/2+2/2xT1+T2 800V-FM</b>	<b>GAK 2+2/2+2/2xT1+T2 1000V-FM</b>
Article-No.		80 01 21	80 01 23	80 01 31	80 01 54
Max. system voltage	UocSTC	800 V=	1000 V=	800 V=	1000 V=
Max. current per input terminal (+)		57 A DC	57 A DC	57 A DC	57 A DC
Max. current per output terminal		57 A DC	57 A DC	57 A DC	57 A DC
Operating temperature range	TU	-40 - +80 °C	-40 - +80 °C	-40 - +80 °C	-40 - +80 °C
Cross section for E-terminals (entry)		16 mm <sup>2</sup>	16 mm <sup>2</sup>	16 mm <sup>2</sup>	16 mm <sup>2</sup>
Cross section for A-terminals (exit)		16 mm <sup>2</sup> single wire / stranded	16 mm <sup>2</sup> single wire / stranded	16 mm <sup>2</sup> single wire / stranded	16 mm <sup>2</sup> single wire / stranded
Cable feedthrough		10x M20	9x M20	9x M20	9x M20
Degree of protection (IEC EN 60529)		IP 66	IP 66	IP 66	IP 66
Dimensions (L x W x H)		300 x 200 x 132 mm	300 x 200 x 132 mm	300 x 200 x 132 mm	300 x 200 x 132 mm
SPD acc. to EN 61643-11		Type 2 / class II	Type 2 / class II	Type 1 + 2 / class I + II	Type 1 + 2 / class I + II



Technical Data		
<b>Product name</b>		<b>PV DC 2.800-2-FM</b>
Article-No.		80 01 41
Max. system voltage	UocSTC	800 V=
Max. current per input terminal (+)		57 A DC
Max. current per output terminal		57 A DC
Operating temperature range	TU	-40 - +80 °C
Cross section for E-terminals (entry)		16 mm <sup>2</sup>
Cross section for A-terminals (exit)		16 mm <sup>2</sup> single wire / stranded
Cable feedthrough		9x M16
Degree of protection (IEC EN 60529)		IP 66
Dimensions (L x W x H)		300 x 200 x 132 mm
SPD acc. to EN 61643-11		Type 1 + 2 / class I + II



# GENERATOR CONNECTION BOXES WITHOUT STRAND FUSES

## GAK 3x1 / GAK 6x1 / GAK 8x2 / GAK 9x1

Generator Connection Boxes for middle or big sized PV systems. They are free combinable and for high generator power. The technical connection conditions of the inverter manufacturer are to be observed! If several module strings are connected in parallel, the instructions of the module manufacturer regarding reverse current resistance must be observed.



example image

- Housing of surface mounting is UV resistant
- double cable feedthrough
- Terminals can be used as points of measurement
- With remote signalling contact (FM)
- EAC certification
- Degree of protection (IEC EN 60529): IP66

### Technical Data

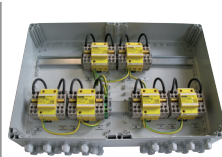

Product name	GAK 3x1/3x1/3xT1+T2 1000V-FM	GAK 6x1/6x1/6xT1+T2 1000V-FM	PV DC 3.800-3-S2-FM	PV DC 3.800-3-FM
Article-No.	80 01 33	80 01 35	80 01 77	80 01 76
Max. system voltage	UocSTC 1000 V=	1000 V=	800 V=	800 V=
Max. current per input terminal (+)	76 A DC	76 A DC	76 A DC	76 A DC
Max. current per output terminal	76 A DC	76 A DC	76 A DC	76 A DC
Operating temperature range	TU -40 - +80 °C	-40 - +80 °C	-40 - +80 °C	-40 - +80 °C
Cross section for E-terminals (entry)	16 mm <sup>2</sup>	16 mm <sup>2</sup>	16 mm <sup>2</sup>	16 mm <sup>2</sup>
Cross section for A-terminals (exit)	16 mm <sup>2</sup> single wire / stranded	16 mm <sup>2</sup> single wire / stranded	16 mm <sup>2</sup> single wire / stranded	16 mm <sup>2</sup> single wire / stranded
Cable feedthrough	13x M16	25x M16	13x M16	13x M16
Degree of protection (IEC EN 60529)	IP 66	IP 66	IP 66	IP 66
Dimensions (L x W x H)	400 x 200 x 132 mm	600 x 400 x 132 mm	400 x 200 x 132 mm	400 x 200 x 132 mm
SPD acc. to EN 61643-11	Type 1 + 2 / class I + II	Type 1 + 2 / class I + II	Type 1 + 2 / class I + II	Type 2 / class II

### Technical Data

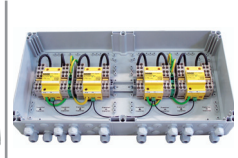
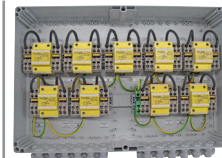
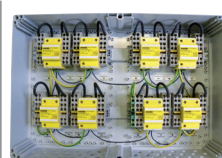
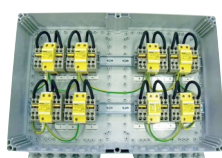

Product name	PV DC 8.800-8-FM	GAK 8x2/8x2/8xT1+T2 1000V-FM	GAK 9x1/9x1/9xT1+T2 1000V-FM	GAK 4x3/4xT1+T2 1000V-FM
Article-No.	80 01 78	80 01 56	80 01 80	80 01 64
Max. system voltage	UocSTC 800 V=	1000 V=	1000 V=	1000 V=
Max. current per input terminal (+)	76 A DC	57 A DC	76 A DC	57 A DC
Max. current per output terminal	76 A DC	57 A DC	76 A DC	57 A DC
Operating temperature range	TU -40 - +80 °C	-40 - +80 °C	-40 - +80 °C	-40 - +80 °C
Cross section for E-terminals (entry)	16 mm <sup>2</sup>	16 mm <sup>2</sup>	16 mm <sup>2</sup>	16 mm <sup>2</sup>
Cross section for A-terminals (exit)	16 mm <sup>2</sup> flex.	16 mm <sup>2</sup> flex.	16 mm <sup>2</sup> flex.	16 mm <sup>2</sup> flex.
Cable feedthrough	33x M16	36x M16	37x M16	17x M20
Degree of protection (IEC EN 60529)	IP 66	IP 66	IP 66	IP 66
Dimensions (L x W x H)	600 x 400 x 132 mm	600 x 400 x 132 mm	600 x 400 x 132 mm	600 x 300 x 132 mm
SPD acc. to EN 61643-11	Type 1 + 2 / class I + II	Type 1 + 2 / class I + II	Type 1 + 2 / class I + II	Type 1 + 2 / class I + II





## GAK 1x2 / GAK 2x2 / GAK 3x2 / GAK 4x2 / GAK 6x2-DSK

Generator connection box with fuse holders to take dc string fuses on plus or minus side. For PV systems to protect the inverter rectifier.

The technical connection conditions of the inverter manufacturer are to be observed! If several module strings are connected in parallel, the instructions of the module manufacturer regarding reverse current resistance must be observed.

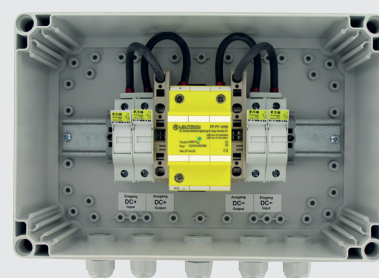

example image

- Housing of surface mounting is UV resistant
- Per arrester on both sides: each two fuse holder for minus pole and plus pole
- Terminals can be used as points of measurement
- With remote signalling contact (FM)
- EAC certification
- Degree of protection (IEC EN 60529): IP66

### Technical Data

Product name	GAK 1x2 T1+T2 1000V-DSK-FM	GAK 2x2 T1+T2 1000V-DSK-FM	GAK 3x2 T1+T2 1000V-DSK-FM	GAK 4x2 T1+T2 1000V-DSK-FM
Article-No.	80 04 44	80 04 43	80 04 42	80 04 41
Max. system voltage	UocSTC 1000 V=	1000 V=	1000 V=	1000 V=
Max. current per input terminal (+)	30 A DC	30 A DC	30 A DC	30 A DC
Max. current per output terminal	57 A DC	57 A DC	57 A DC	57 A DC
Operating temperature range	TU -40 - +80 °C	-40 - +80 °C	-40 - +80 °C	-40 - +80 °C
Cross section for E-terminals (entry)	16 mm <sup>2</sup>	16 mm <sup>2</sup>	16 mm <sup>2</sup>	16 mm <sup>2</sup>
Cross section for A-terminals (exit)	16 mm <sup>2</sup> single wire / stranded	16 mm <sup>2</sup> single wire / stranded	16 mm <sup>2</sup> single wire / stranded	16 mm <sup>2</sup> single wire / stranded
Cable feedthrough	5x M20	9x M20	13x M20	17x M20
Degree of protection (IEC EN 60529)	IP 66	IP 66	IP 66	IP 66
Dimensions of housing (H x W x D)	300 x 200 x 132 mm	400 x 200 x 132 mm	600 x 300 x 132 mm	600 x 400 x 132 mm
Net weight / pc	1600 g	2500 g	6000 g	6500 g
SPD acc. to EN 61643-11	Type 1 + 2 / class I + II	Type 1 + 2 / class I + II	Type 1 + 2 / class I + II	Type 1 + 2 / class I + II



### Technical Data

Product name	GAK 6x2 T1+T2 1000V-DSK-FM
Article-No.	80 04 40
Max. system voltage	UocSTC 1000 V=
Max. current per input terminal (+)	30 A DC
Max. current per output terminal	57 A DC
Operating temperature range	TU -40 - +80 °C
Cross section for E-terminals (entry)	16 mm <sup>2</sup>
Cross section for A-terminals (exit)	16 mm <sup>2</sup> single wire / stranded
Cable feedthrough	25x M20
Degree of protection (IEC EN 60529)	IP 66
Dimensions of housing (H x W x D)	600 x 400 x 132 mm
Net weight / pc	7000 g
SPD acc. to EN 61643-11	Type 1 + 2 / class I + II



# GENERATOR CONNECTION BOXES WITH REVERSE CURRENT FUSE

## GAK 1x3 / GAK 2x3 / GAK 4x3-DSK

Generator connection box with fuse holders to take dc string fuses on plus or minus side. For PV systems to protect the inverter rectifier. The technical connection conditions of the inverter manufacturer are to be observed! If several module strings are connected in parallel, the instructions of the module manufacturer regarding reverse current resistance must be observed.



example image

- Housing of surface mounting are UV resistant / IP 66
- Per arrester on both sides: each three fuse holder for minus pole and plus pole
- Terminals can be used as points of measurement
- With remote signalling contact (FM)
- EAC certification

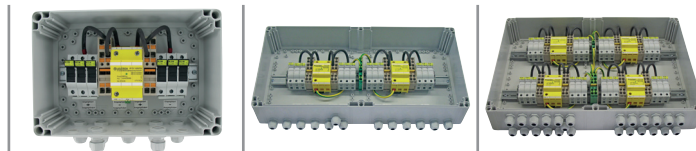

### Technical Data

Product name		GAK 1x3 T1+T2 1000V-DSK-FM	GAK 2x3 T1+T2 1000V-DSK-FM	GAK 4x3 T1+T2 1000V-DSK-FM
Article-No.		80 04 47	80 04 48	80 04 49
Max. system voltage	UocSTC	1000 V=	1000 V=	1000 V=
Max. current per input terminal (+)		30 A DC	30 A DC	30 A DC
Max. current per output terminal		57 A DC	57 A DC	57 A DC
Operating temperature range	TU	-40 - +80 °C	-40 - +80 °C	-40 - +80 °C
Cross section for E-terminals (entry)		16 mm <sup>2</sup>	16 mm <sup>2</sup>	16 mm <sup>2</sup>
Cross section for A-terminals (exit)		16 mm <sup>2</sup> single wire / stranded	16 mm <sup>2</sup> single wire / stranded	16 mm <sup>2</sup> single wire / stranded
Cable feedthrough		7x M20	13x M20	25x M20
Degree of protection (IEC EN 60529)		IP 66	IP 66	IP 66
Dimensions of housing (H x W x D)		300 x 200 x 132 mm	600 x 300 x 132 mm	600 x 400 x 132 mm
Net weight / pc		2600 g	6500 g	7000 g
SPD acc. to EN 61643-11		Type 1 + 2 / class I + II	Type 1 + 2 / class I + II	Type 1 + 2 / class I + II



## GAK 2x5 T1+T2 1000V-DSK

Generator connection box with fuse holders to take dc string fuses on plus or minus side. For PV systems to protect the inverter rectifier with two MPP trackers.

The technical connection conditions of the inverter manufacturer are to be observed! If several module strings are connected in parallel, the instructions of the module manufacturer regarding reverse current resistance must be observed.

- Housing of surface mounting (600 x 300 x 132 mm) / IP66
- Input / Output: five strings in for plus and five strings out for minus
- Two combined arrester Type 1+ 2 with 1000 V dc
- For two MPP trackers
- With remote signalling contact (FM)
- EAC certification

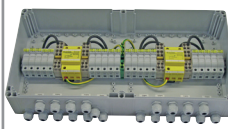
	
<b>Technical Data</b>	
<b>Product name</b>	<b>GAK 2x5 T1+T2 1000V-DSK-FM</b>
Article-No.	80 04 50
Max. system voltage	UocSTC 1000 V=
Max. current per input terminal (+)	30 A DC
Max. current per output terminal	57 A DC
Operating temperature range	TU -40 - +80 °C
Cross section for E-terminals (entry)	16 mm <sup>2</sup>
Cross section for A-terminals (exit)	16 mm <sup>2</sup> single wire / stranded
Cable feedthrough	21x M20
Degree of protection (IEC EN 60529)	IP 66
Dimensions of housing (H x W x D)	600 x 300 x 132 mm
Net weight / pc	7000 g
SPD acc. to EN 61643-11	Type 1 + 2 / class I + II

## GAK 5x1 T1+T2 1000V

Generator connection box with fuse holders to take dc string fuses on plus or minus side. For PV systems to protect the inverter with five MPP trackers.

The technical connection conditions of the inverter manufacturer are to be observed! If several module strings are connected in parallel, the instructions of the module manufacturer regarding reverse current resistance must be observed.

- Housing of surface mounting are UV resistant / IP 66
- Input / Output: parallel circuit of each one string
- Five DC combined arrester Type 1 + Type 2 / class II with 1000V
- For five MPP tracker
- With remote signalling contact (FM)
- EAC certification

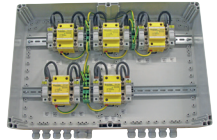
	
<b>Technical Data</b>	
<b>Product name</b>	<b>GAK 5x1 T1+T2 1000V-FM</b>
Article-No.	80 04 55
Max. system voltage	UocSTC 100 V=
Max. current per input terminal (+)	30 A DC
Max. current per output terminal	76 A DC
Operating temperature range	TU -40 - +80 °C
Cross section for E-terminals (entry)	16 mm <sup>2</sup>
Cross section for A-terminals (exit)	16 mm <sup>2</sup> single wire / stranded
Cable feedthrough	11x M20
Degree of protection (IEC EN 60529)	IP 66
Dimensions of housing (H x W x D)	600 x 400 x 132 mm
net weight	6500 g
SPD acc. to EN 61643-11	Type 1 + 2 / class I + II



# GENERATOR CONNECTION BOXES WITH REVERSE CURRENT FUSE

## GAK 1x1 / GAK 1x6 / GAK 1x12 /GAK 1x9

Generator connection box with fuse holders to take dc string fuses on plus or minus side. For PV systems to protect the inverter with one MPP tracker. The technical connection conditions of the inverter manufacturer are to be observed! If several module strings are connected in parallel, the instructions of the module manufacturer regarding reverse current resistance must be observed.

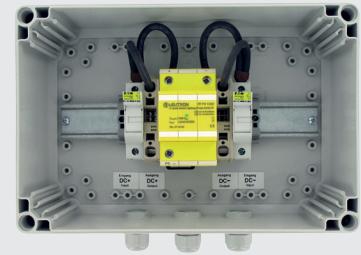

example image

- One combined arrester Type 1+ 2 with 1000 V dc
- For one MPP tracker
- With remote signalling contact (FM)
- EAC certification

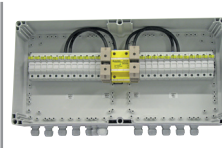
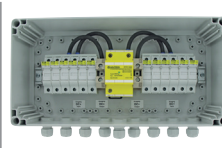
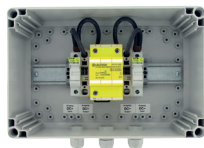

without image

### Technical Data

Product name	GAK 1x1 T1+T2 1000V-FM	GAK 1x6 T1+T2 1000V-FM	GAK 1x12 T1+T2 1000V-FM	GAK 1x9 T1+T2 1000V-FM
Article-No.	80 04 45	80 04 51	80 04 54	<b>80 04 59</b>
Max. system voltage	UocSTC 1000 V=	1000 V=	100 V=	1000 V=
Max. current per input terminal (+)	30 A DC	30 A DC	30 A DC	30 A DC
Max. current per output terminal	76 A DC	125 A DC	220 A DC	125 A DC
Operating temperature range	TU -40 - +80 °C	-40 - +80 °C	-40- +80 °C	-40- +80 °C
Cross section for E-terminals (entry)	16 mm <sup>2</sup>	16 mm <sup>2</sup>	16 mm <sup>2</sup>	16 mm <sup>2</sup>
Cross section for A-terminals (exit)	16 mm <sup>2</sup> single wire / stranded	35 mm <sup>2</sup>	95 mm <sup>2</sup> single wire / 120 mm <sup>2</sup> stranded	35 mm <sup>2</sup>
Cable feedthrough	3x M20	7x M20 / 2x M25	13x M20 / 2x M25	12x M20
Degree of protection (IEC EN 60529)	IP 66	IP 66	IP 66	IP 66
Dimensions of housing (H x W x D)	300 x 200 x 132 mm	400 x 200 x 132 mm	600 x 300 x 132 mm	600 x 300 x 132 mm
Net weight / pc	1500 g	3500 g	7000 g	n. i.
SPD acc. to EN 61643-11	Type 1 + 2 / class I + II	Type 1 + 2 / class I + II	Type 1 + 2 / class I + II	Type 1 + 2 / class I + II



## GAK 2x1 / GAK 2x3 / GAK 2x4

Generator connection box with fuse holders to take dc string fuses on plus or minus side. For PV systems to protect the inverter with two MPP trackers. The technical connection conditions of the inverter manufacturer are to be observed! If several module strings are connected in parallel, the instructions of the module manufacturer regarding reverse current resistance must be observed.



example image

- Two combined arrester Type 1+ 2 with 1000 V dc
- For two MPP tracker
- With remote signalling contact (FM)
- EAC certification

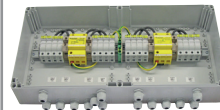
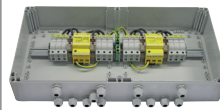

### Technical Data

Product name		GAK 2x1 T1+T2 1000V-FM	GAK 2x3 T1+T2 1000V-FM	GAK 2x4 T1+T2 1000V-FM
Article-No.		80 04 46	80 04 52	80 04 53
Max. system voltage	UocSTC	1000 V=	1000 V=	1000 V=
Max. current per input terminal (+)		30 A DC	30 A DC	30 A DC
Max. current per output terminal		76 A DC	125 A DC	125 A DC
Operating temperature range	TU	-40 - +80 °C	-40 - +80 °C	-40 - +80 °C
Cross section for E-terminals (entry)		16 mm <sup>2</sup>	16 mm <sup>2</sup>	16 mm <sup>2</sup>
Cross section for A-terminals (exit)		16 mm <sup>2</sup> single wire / stranded	35 mm <sup>2</sup>	35 mm <sup>2</sup>
Cable feedthrough		5x M20	9x M20 / 4x M25	11x M20 / 4x M25
Degree of protection (IEC EN 60529)		IP 66	IP 66	IP 66
Dimensions of housing (H x W x D)		300 x 200 x 132 mm	600 x 300 x 132 mm	600 x 300 x 132 mm
Net weight		2500 g	6500 g	6000 g
SPD acc. to EN 61643-11		Type 1 + 2 / class I + II	Type 1 + 2 / class I + II	Type 1 + 2 / class I + II



## Complete protection of inverter

### PV AC-DC

For 1 or more strings in 1 or 3 phase AC systems. Complete overvoltage protection for inverters. Mounting it directly nearby inverter is advantageous. The technical connection conditions of the inverter manufacturer are to be observed! If several module strings are connected in parallel, the instructions of the module manufacturer regarding reverse current resistance must be observed.

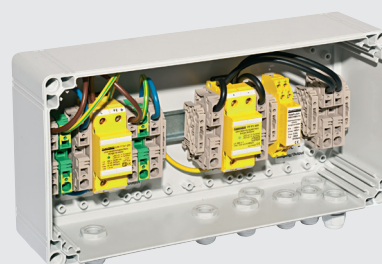

example image

- AC side: surge arrester Type 2 / class II
- DC side: combined arrester Type 1 + Type 2 / class II
- Signal and data line protection: IEC category C1/C2/C3
- With remote signalling contact (FM)
- EAC certification

#### Technical Data

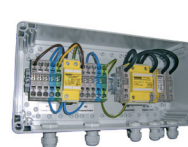
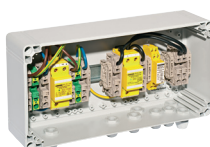

Product name	PV AC-DC 1.1-800-FM	PV AC-DC 3.1-800-FM	PV AC-DC 1.1-1000-FM	PV AC-DC 1.2-800-FM
Article-No.	80 01 43	80 01 45	80 01 81	80 01 82
Max. system voltage	UocSTC 800 V=	800 V=	1000 V=	800 V=
Max. current per input terminal (+)	76 A DC	76 A DC	76 A DC	76 A DC
Max. current per output terminal	30 A DC	30 A DC	30 A DC	30 A DC
Operating temperature range	TU -40 - +80 °C	-40 - +80 °C	-40 - +80 °C	-40 - +80 °C
Cross section for E-terminals (entry)	16 mm <sup>2</sup>	16 mm <sup>2</sup>	16 mm <sup>2</sup>	16 mm <sup>2</sup>
Cross section for A-terminals (exit)	16 mm <sup>2</sup> flex. mm <sup>2</sup>	16 mm <sup>2</sup> flex. mm <sup>2</sup>	16 mm <sup>2</sup> flex. mm <sup>2</sup>	16 mm <sup>2</sup> flex. mm <sup>2</sup>
Cable feedthrough	6x M20 / 2x M25	6x M20 / 2x M25	6x M20/2x M25	10x M20 / 2x M25
Dimensions (L x W x H)	400 x 200 x 132 mm	400 x 200 x 132 mm	400 x 200 x 132 mm	400 x 200 x 132 mm
Degree of protection (IEC EN 60529)	IP 66	IP 66	IP 66	IP 66
SPD acc. to EN 61643-11	Type 1 + 2 / class I + II	Type 1 + 2 / class I + II	Type 1 + 2 / class I + II	Type 1 + 2 / class I + II

#### Technical Data

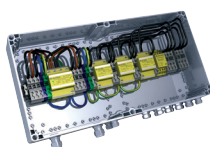

Product name	PV AC-DC 3.3-1000-FM
Article-No.	80 01 83
Max. system voltage	UocSTC 1000 V=
Max. current per input terminal (+)	76 A DC
Max. current per output terminal	30 A DC
Operating temperature range	TU -40 - +80 °C
Cross section for E-terminals (entry)	16 mm <sup>2</sup>
Cross section for A-terminals (exit)	16 mm <sup>2</sup> flex. mm <sup>2</sup>
Cable feedthrough	14x M20 / 2x M25
Dimensions (L x W x H)	600 x 300 x 132 mm
Degree of protection (IEC EN 60529)	IP 66
SPD acc. to EN 61643-11	Type 1 + 2 / class I + II



## Protection of inverter rectifier AC-side

### GAK AC

Generator connection box for 3 phase TNS systems. Application: e. g. at PV systems to protect the AC side of the inverter rectifier.  
The technical connection conditions of the inverter manufacturer are to be observed! If several module strings are connected in parallel, the instructions of the module manufacturer regarding reverse current resistance must be observed.

- Housing of surface mounting (300 x 200 x 132 mm) / IP66
- 4 pole combined arrester PP BC TNS 25/100/FM
- With remote signalling contact (FM)
- EAC certification



Technical Data	
<b>Product name</b>	<b>GAK AC-3 T1+T2-FM</b>
Article-No.	80 01 84
Cross section for E-terminals (entry)	16 mm <sup>2</sup>
Cross section for A-terminals (exit)	16 mm <sup>2</sup> single wire / stranded
Cable feedthrough	2x M25/1x M20
Degree of protection (IEC EN 60529)	IP 66
Dimensions (L x W x H)	300 x 200 x 132 mm
Operating temperature range	TU -40 - +80 °C
SPD acc. to EN 61643-11	Typ Type 1 + 2 / class I + II
Nominal voltage AC	UN 230/400 V~
Max. continuous operating voltage AC (50/60Hz)	Uc 255 V~
Insulation resistance	Risol > 10 GΩ
Protection level at 100% lightn. impulse sparkover voltage (1.2/50µs)	Up ≤ 2,5 kV
Protection level at limp L-PE	Up ≤ 2,5 kV
Lightning impulse current (10/350) L1+L2+L3+N-PE	Itotal 100 kA
Lightning impulse current (10/350) L,N-PE	limp 25 kA
Follow-on current extinguishing capability at Uc (50/60 Hz) Ifi	4 kA
Short-circuit withstand capability at max. back-up fuse	Ik 50 kAeff
Max. acceptable back-up fuse F2 (spur wiring)	250 A gL/gG

## Special edition GAK

### PV DC 1/1

Generator connection box for maximum one string for one MPP tracker. For connection with MC4 connectors.  
The technical connection conditions of the inverter manufacturer are to be observed! If several module strings are connected in parallel, the instructions of the module manufacturer regarding reverse current resistance must be observed.

- Housing of surface mounting (200 x 200 x 132 mm) / IP66
- Input / Output: parallel circuit of each one string
- One combined arrester Type 1+ 2 with 1000 V dc
- With remote signalling contact (FM)
- EAC certification



Technical Data	
<b>Product name</b>	<b>PV DC 1/1 1xT1+2 1000V/ MC4-FM</b>
Article-No.	80 01 79
Max. system voltage	UocSTC 1000 V=
Max. nominal current per MC4 plug socket	30 A
Max. nominal current per MC4 jack	30 A
Operating temperature range	TU -40 - +80 °C
Cable feedthrough	1x M16 / 4x MC4
Degree of protection (IEC EN 60529)	IP 66
Dimensions (L x W x H)	200 x 200 x 132 mm
SPD acc. to EN 61643-11	Type 1 + 2 / class I + II



## Special edition GAK

### Fuse Combiner Box

The technical connection conditions of the inverter manufacturer are to be observed! If several module strings are connected in parallel, the instructions of the module manufacturer regarding reverse current resistance must be observed.

- Housing of surface mounting (200 x 200 x 132 mm) / IP66
- with string fuses of 12A , up to 1000 V DC
- Protection of batteries in PV systems

		
<b>Technical Data</b>		
<b>Product name</b>	<b>Fuse Combiner Box</b>	
Article-No.	80 01 72	
Operating temperature range	TU	-50 - +120 °C
Querschnitt Klemme	16 mm <sup>2</sup> single wire / stranded	
Cable feedthrough	6x M16	
Dimensions (L x W x H)	200 x 200 x 132 mm	
Degree of protection (IEC EN 60529)	IP 66/67	

### GAK 2x2 Zw

Generator connection box without surge protection. Application: in PV systems; Stringbox to protect the inverter with two MPP trackers or four terminals per plus and minus pole each.

The technical connection conditions of the inverter manufacturer are to be observed! If several module strings are connected in parallel, the instructions of the module manufacturer regarding reverse current resistance must be observed.

- Housing of surface mounting (200 x 200 x 132 mm) / IP66
- without surge protective devices

		
<b>Technical Data</b>		
<b>Product name</b>	<b>GAK 2x2 1000V/30A</b>	
Article-No.	80 01 67	
Max. system voltage	UocSTC	1000 V=
Max. current per input terminal (+)	30 A DC	
Max. current per output terminal	30 A DC	
Operating temperature range	TU	-50 - +120 °C
Cross section for E-terminals (entry)	16 mm <sup>2</sup>	
Cross section for A-terminals (exit)	16 flex. mm <sup>2</sup>	
Cable feedthrough	8x M16	
Dimensions (L x W x H)	200 x 200 x 132 mm	
Degree of protection (IEC EN 60529)	IP 66/67	





## PV Connection boxes

Two- and four-pole type 2 surge arrester in IP 65 to protect one MPP input or two MPP inputs.

Simple and quick implementation of the surge protection, as no additional space is required in a separate insulating housing. The function display is mechanical: the status of the surge arrester is displayed optically.

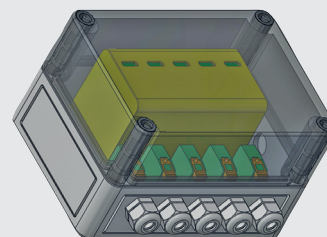

example image



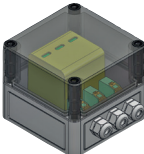
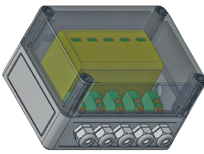

- DC SPD type 2 with 1000 V
- For one or two MPP tracker

			
<b>Technical Data</b>			
<b>Product name</b>	<b>PV AB 1000 1M</b>	<b>PV AB 1000 2M</b>	
Article-No.	80 05 70	80 05 80	
SPD nach EN 61643-11	Typ 2 / class II	Typ 2 / class II	
Max. system voltage	UocSTC 1000 V=	1000 V=	
Total discharge current (8/20 μs)	I <sub>total</sub> 40 kA	40 kA	
Nominal discharge current (8/20 μs)	I <sub>n</sub> 12,5 kA	12,5 kA	
Max. discharge current (8/20 μs)	I <sub>max</sub> 25 kA	25 kA	
Protection level	U <sub>p</sub> ≤ 4 kV	≤ 4 kV	
Protection level at 5 kA	U <sub>p</sub> ≤ 3,5 kV	≤ 3,5 kV	
Response time	t <sub>A</sub> 25 ns	25 ns	
Operating temperature range	TU -35 - +80 °C	-35 - +80 °C	
Min. conductor cross section at terminals	2.5 mm <sup>2</sup> flexible	2.5 mm <sup>2</sup> flexible	
Max. conductor cross section at terminals	6 mm <sup>2</sup> solid / fine stranded	6 mm <sup>2</sup> solid / fine stranded	
Degree of protection (IEC EN 60529)	IP 65	IP 65	
Cable feedthrough	3x Ø 3-7 mm	5x Ø 3-7 mm	
Dimensions (L x W x H)	94 x 94 x 81 mm	130 x 94 x 81 mm	



## Accessories GAK

### String fuses

String fuses for PV modules:					
<b>Technical Data</b>					
<b>Product name</b>	<b>ST-Si/4A</b>	<b>ST-Si/8A</b>	<b>ST-Si/10A</b>	<b>ST-Si/12A</b>	<b>ST-Si/20A</b>
Article-No.	17 01 51	17 01 52	17 01 53	17 01 54	17 01 56
Rated current	4 A	8 A	10 A	12 A	20 A
Rated voltage	1000 V <sub>AC/DC</sub>	1000 V <sub>AC/DC</sub>	1000 V <sub>AC/DC</sub>	1000 V <sub>AC/DC</sub>	1000 V <sub>AC/DC</sub>
Dimension (Ø x L)	10 x 38 mm	10 x 38 mm	10 x 38 mm	10 x 38 mm	10 x 38 mm
piece/unit	10	10	10	10	10

### DAK 2x 16

Pin-shaped terminal to enable feed-through wiring (V-wiring) for all surge protection modules with only one clamp per phase, such as PP PV 800 and 1000 and other SPDs for power supply systems.

- Looped-in wiring for SPD with only one connection terminal
- Connection of 2 lines at only one terminal possible
- AnConnection of max. 2x 16 mm<sup>2</sup> fine-stranded
- Conformed by standard looped-in wiring (V connected)
- Acc. to DIN VDE 0100-534

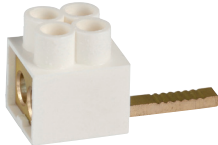
	
<b>Technical Data</b>	
<b>Product name</b>	<b>DAK 2x 16</b>
Article-No.	17 01 10
Type of connection	front: double terminal, back: connection
Conductor cross section	2x 16 mm <sup>2</sup>
Dimensions (L x W x H)	17 x 38,5 x 21 mm

### Air-rating plug M12

Ventilation device, with membran to ventilate the generator connection box in an optimal way.

	
<b>Technical Data</b>	
<b>Product name</b>	<b>E-Membran M12</b>
Article-No.	17 01 40
Dimension (Ø x L)	19 x 17 mm
Degree of protection (IEC EN 60529)	IP 68
Material inhousing	PA6-V2
Recommended tightening torque	0,5-1,0 Nm
Operating temperature range	TU -40 - +105 °C
Membran material	Acrylic-co-polymer on nylon support



**Product Standards****DIN EN 60099-4:2015; VDE 0675-4:2015**

Metal-oxide surge arresters without spark gaps for alternating voltage grids (IEC 60099-4:2014)

**DIN EN 61643-11; VDE 0675-6-11:2019-03**

Low-voltage surge protective devices  
Part 11: Surge protective devices connected to low-voltage power systems  
Requirements and test methods  
(IEC 61643-11:2011, modified);

**DIN EN 61643-21; VDE 0845-3-1:2013-07**

Low voltage surge protective devices  
Part 21: Surge protective devices connected to telecommunications and signaling networks  
Performance requirements and testing methods  
(IEC 61643-21:2012-07 + A1:2008, + A2:2012 modified)

**DIN EN 62561-3 VDE 0185-561-3:2018-02**

Lightning protection system components (LPSC)  
Part 3: Requirements for isolating spark gaps (ISG)  
(IEC 62561-3:2017)

**DIN EN 50539-11:2013-12; VDE 0675-39-11:2013-12**

Low-voltage surge protective devices  
Surge protective devices for specific application including direct current  
Part 11: Requirements and tests for SPDs in photovoltaic applications

**DIN CLC/TS 50539-12:2014-09; VDE V 0675-39-12:2014-09**

Low-voltage surge protective devices  
Surge protective devices for specific application including direct current  
Part 12: Selection and application principles - SPDs connected to photovoltaic installations

**DIN EN 60715:2018-07**

Dimensions of low-voltage switchgear and controlgear  
Standardized mounting on rails for mechanical support of switchgear, controlgear and accessories  
(IEC 60715:2017)

**DIN EN 60529:2014-09; VDE 0470-1:2014-09**

Degrees of protection provided by enclosures (IP Code)  
(IEC 60529:2004)

**DIN EN 60068-2-6:2008-10; VDE 0468-2-6:2008-10**

Environmental testing  
Part 2-6: Tests - Test Fc: Vibration (sinusoidal)  
(IEC 60068-2-6:2007)

**DIN EN 60068-2-27:2010-02; VDE 0468-2-27:2010-02**

Environmental testing  
Part 2-27: Tests - Test Ea and guidance: Shock  
(IEC 60068-2-27:2008)

**DIN EN 60079-0:2014-06; VDE 0170-1:2014-06**

Explosive atmospheres  
Part 0: Equipment, General requirements  
(IEC 60079-0:2011, modified + Corrigendum:2012 + Corrigendum:2013)

**EN 60079-18:2015-10**

Explosive atmospheres  
Part 18: Equipment protection by encapsulation „m“  
(IEC 60079-18:2014)

**Application Standards and Rules****DIN VDE 0100-100:2009-06**

Low-voltage electrical installations  
Part 1: Fundamental principles, assessment of general characteristics, definitions  
(IEC 60364-1:2005, modified); German implementation HD 60364-1:2008

**DIN VDE 0100-410; VDE 0100-410:2018-10**

Low-voltage electrical installations  
Part 4-41: Protection for safety  
Protection against electric shock  
(IEC 60364-4-41:2005, modified + A1:2017, modified);  
German implementation of HD 60364-4-41:2017 + A11:2017

**DIN VDE 0100-443; VDE 0100-443:2016-10**

Low-voltage electrical installations  
Part 4-44: Protection for safety  
Protection against voltage disturbances and electromagnetic disturbances  
Section 443: Protection against transient overvoltage's of atmospheric origin or due to switching  
(IEC 60364-4-44:2007/A1:2015, modified)

**DIN VDE 0100-534; VDE 0100-534:2016-10**

Low-voltage electrical installations  
Part 5-53: Selection and erection of electrical equipment  
Isolation, switching and control  
Section 534: Devices for protection against transient overvoltage  
(IEC 60364-5-53:2001/A2:2015, modified)

**DIN VDE 0100-712; VDE 0100-712:2016-10**

Low-voltage electrical installations  
Part 7-712: Requirements for special installations or locations  
Photovoltaic (PV) systems  
German implementation HD 60364-7-712:2016

**DIN EN 62305-1; VDE 0185-305-1:2011-10**

E DIN EN 62305-1 VDE 0185-305-1:2015-12 (IEC 81/472/CD:2015) Draft standard, valid.  
Protection against lightning  
Part 1: General principles (IEC 62305-1:2010, modified)

**DIN EN 62305-2; VDE 0185-305-2:2013-02**

Protection against lightning  
Part 2: Risk management (IEC 62305-2:2010, modified)

**DIN EN 62305-3; VDE 0185-305-3:2011-10**

E DIN EN 62305-3 VDE 0185-305-3:2016-04 (IEC 81/476/CD:2015) Draft standard, valid.  
Protection against lightning  
Part 3: Physical damage to structures and life hazard (IEC 62305-3:2010, modified)

**DIN EN 62305-4; VDE 0185-305-4:2011-10**

E DIN EN 62305-4 VDE 0185-305-4:2016-04 (IEC 81/478/CD:2015) Draft standard, valid. Protection against lightning  
Part 4: Electrical and electronic systems within structures  
(IEC 62305-4:2010, modified)

**DIN EN 60695-1-20:2017-02; VDE 0471-1-20:2017-02**

Fire hazard testing  
Part 1-20: Guidance for assessing the fire hazard of electro technical products  
Ignitability  
General guidance (IEC 60695-1-20:2016)



**DIN EN 60695-11-10; VDE 0471-11-10:2014-10**

Fire hazard testing  
Part 11-10: Test flames  
50 W horizontal and vertical flame test methods  
(IEC 60695-11-10:2013)

**UL94 der Underwriters Laboratories (UL)**

Tests for Flammability of Plastic Materials for Parts in Devices and Appliances.  
Describes a method for assessing and classifying the flammability of plastics.  
It became the same content in the standards  
IEC / DIN EN 60695-11-10 and -20 and the Canadian CAN / CSA C 22.2  
No.017 taken over.

**VDE-AR-N 4100 Application Rule: 2019-04**

Technical rules for connecting customer systems to the Low-voltage network and its operation (TAR low voltage)

**VDE-AR-N 4105 Application Rule: 2018-11**

Generation plants on the low voltage grid and their operation (TAR medium voltage)

**VDE-AR-N 4110 Application Rule: 2018-11**

Technical rules for connecting customer systems to the Medium-voltage network and its operation (TAR medium voltage)

**VDE-AR-N 4130 Application Rule: 2018-11**

Technical rules for connecting customer systems to the High-voltage network and its operation (TAR high/maximum voltage)

**Do standards and application rules have to be adhered to?**

The simple answer is „no“.  
Norms are created by private law organizations (see above) and do not have the same status as a law.  
The legislature itself occasionally refers to norms (in which case they are binding in any case). It is then always assumed that a standard represents the current state of the art.

**When is there a dispute over compliance with standards?**

If something went wrong and there was a damage.  
If you believe that you do not have to comply with a standard, then you should have good reasons for doing so and be able to represent it safely and competently in the event of a dispute.

On the safe side you are definitely, if you comply with the valid standards.

It is therefore strongly recommended to know the most important standards and to comply with them during planning and construction.

**Organisation of Standards**

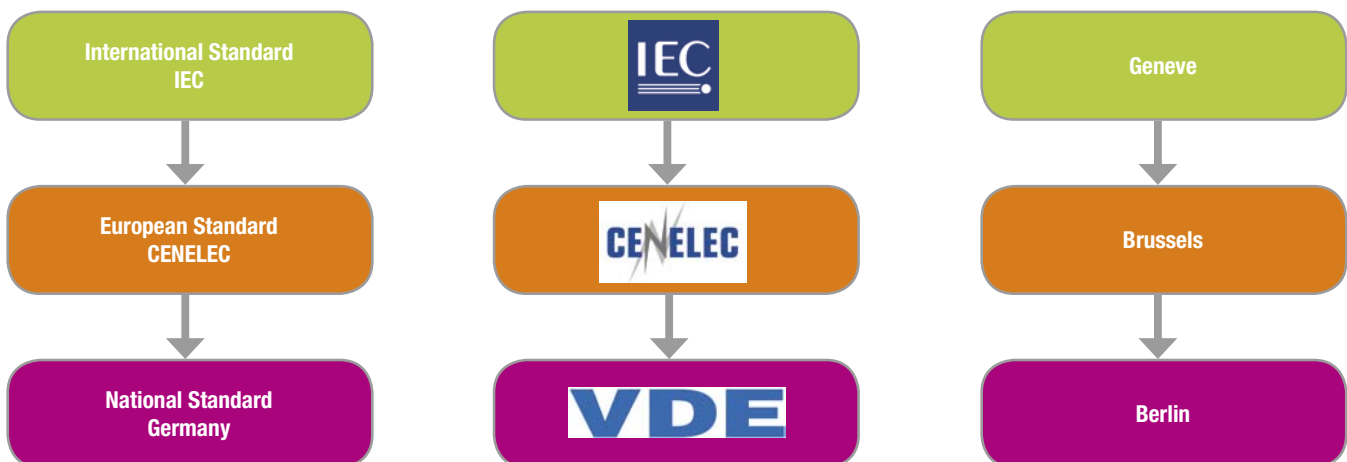



It should be noted that protected and unprotected line are separated.

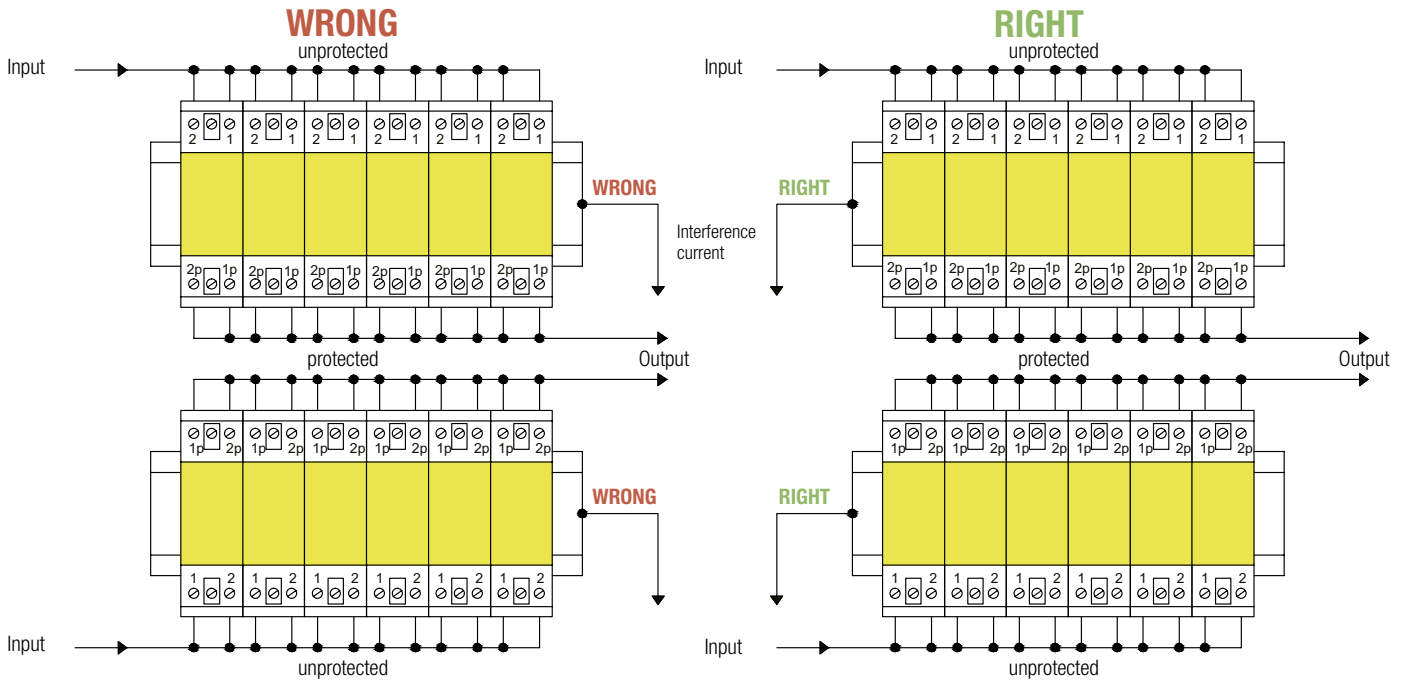

Wiring: Protected and unprotected lines must not be laid side by side in parallel. They are to be separated so that overvoltage input coupling is excluded.

## Installation of cable shields

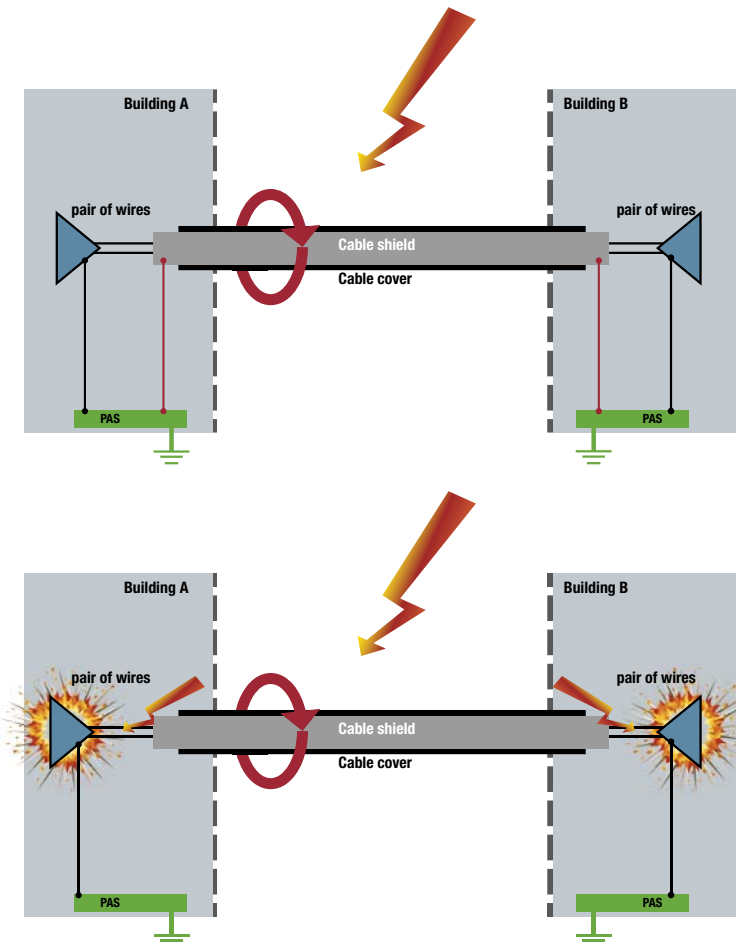

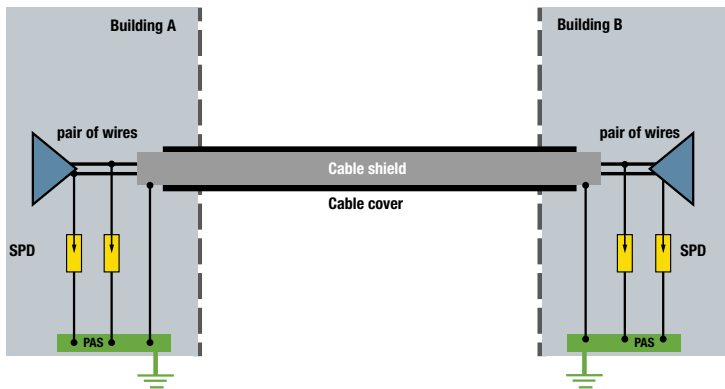

**Bilateral directly shielded connection**

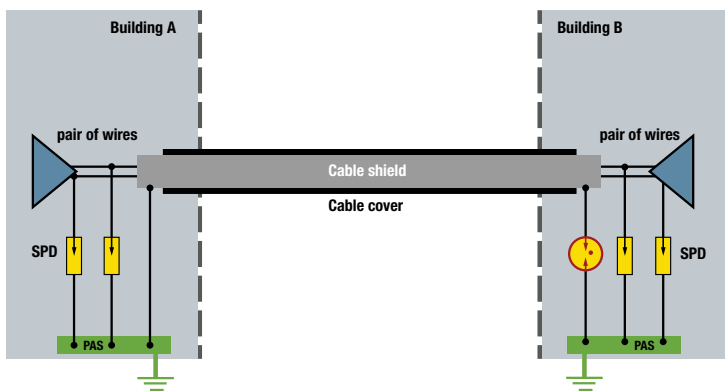

**Indirectly shielded connection – high resistance grounding**

If there is no possibility of earthing the cable shield on both sides because of technological reasons, the non-earthed side has to be connected to the ground via a gas-filled surge arrester (GDT) or an isolation spark gap (up to 100 kA, 10/350 μs).

If a surge occurs, the shield will be connected to the ground via the gas discharge path diverting the energy of the surge. This way, flashovers to the ground, to other cables or installation parts are avoided.

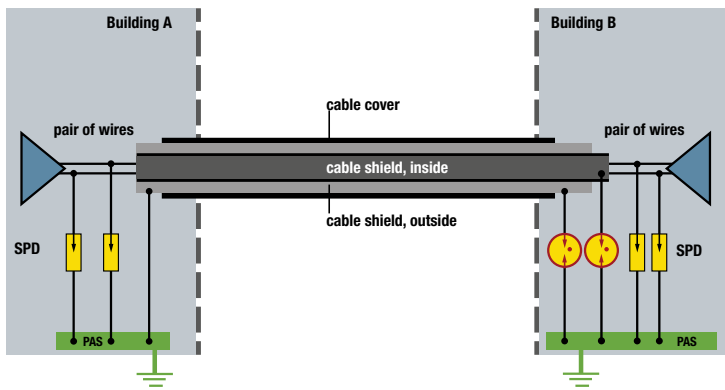

The inner screen is one-sided, the outer screen is connected on both sides. To reduce such disturbing influences in a line screen connected to both sides, a side is often also connected to the reference potential via a capacitor. This interrupts the earth loop at least for direct currents or low-frequency currents.

## Comparison of arrester classification

Surge Protective Device	Power supply	MCR technology*)
Lightning current arrester	DIN EN 61643-11 Type 1 (class I, coarse protection)	DIN EN 61643-21 category D1
Surge protective arrester	Type 2 (class II, middle protection)	category C2
Terminal protection	Type 3 (class III, fine protection)	category C1

\*) test categories by table 3 of DIN EN 61643-21/VDE 0845 3-1:2002



## Overview protection level SPD

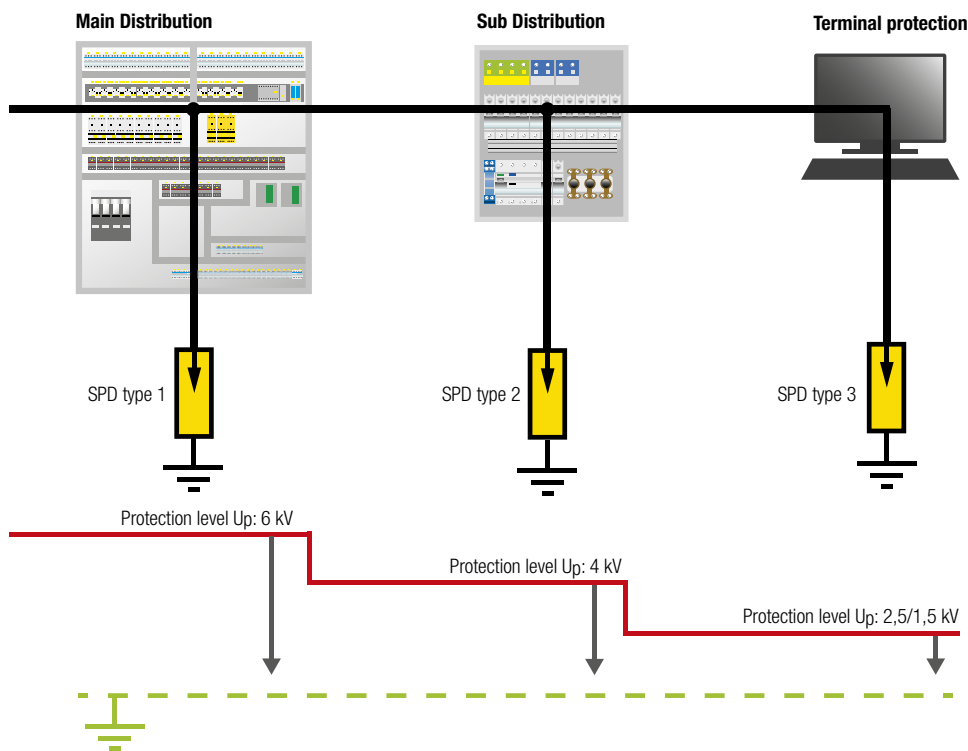

At power supply protection SPDs are always connected parallel to PE, that means: without influence of the lines.

According to the standard, the task of over-voltage arresters is to gradually reduce the lightning currents to an acceptable level.

This means that SPD type 1 must limit the protection level to 4 kV, type 2 to 2.5 kV and type 3 to 1.5 kV.

(acc. to DIN VDE 0100-443, overview table 1)

## Length of lines

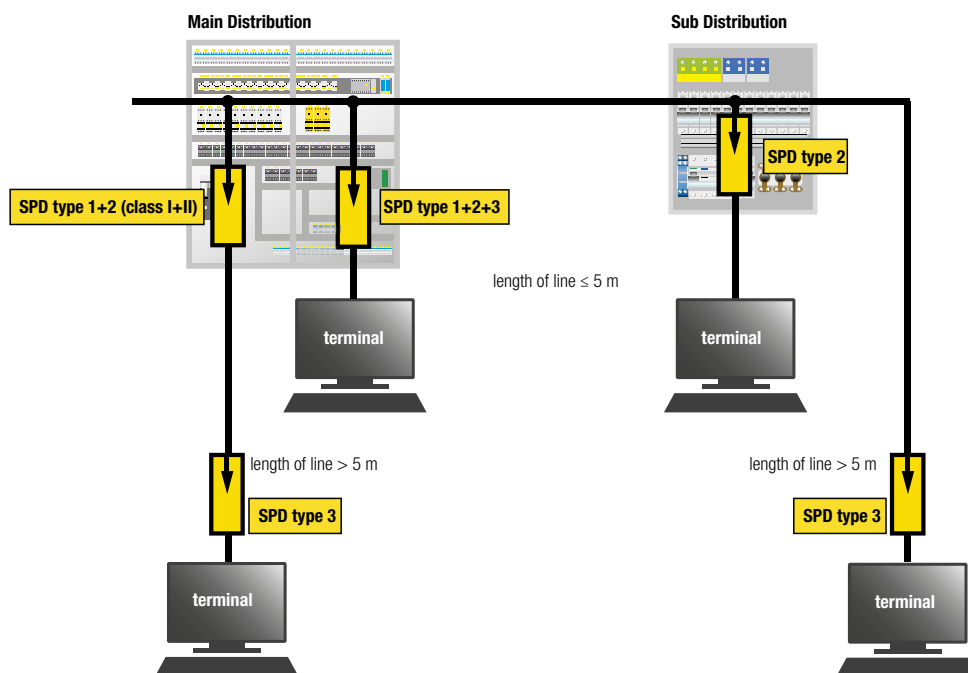





**Active Parts**

Active parts are conductors and conductive parts of equipment that are alive under normal operational conditions.

**Aging**

Aging is the alteration of the original conductivity. It is caused by disturbance pulses, normal operation or unfavourable environmental conditions.

**Approach (today: Separation Distance)**

An approach is a too narrow distance between the lightning protection installation and conductive installations or electrical installations with a risk of a flashover or breakdown at lightning strikes.

**Arc Voltages U<sub>bo</sub>**

The arc voltage is the instantaneous value of the voltage over a discharge path during an arc discharge process.

**Arresters**

Equipment that in general consists of voltage-controlled resistors and/or spark gaps. Both items can be used separately or connected in series or in parallel. Arresters protect other electrical equipment or installations against unacceptable high surge voltages.

**Asymmetrical Interference**

“Asymmetrical” means that the interference source or drain is related to the ground. It exists a capacitive or galvanic connection to the protective conductor.

**Asymmetrical Voltage, Common-Mode Voltage**

Average voltage between every conductor and a specified reference point, usually reference earth or ground.

**Burst**

A burst consists of repeatedly occurring pulses within a certain time period.

**Combined Arrester**

The combined arrester is a surge-voltage protection device consisting of lightning current arrester and surge arrester.

**Combined Impulse**

A combined impulse is generated by a combination wave generator which generates a no-load impulse voltage (1.2/50 µs), respectively, a short-circuit impulse current (8/20 µs). The voltage, the amplitude of the current and the waveforms are determined by the generator and the impedance of the SPD. The ratio of the peak values of the no-load voltage and the short-circuit current is 2 Ohm. This value is called the fictitious impedance Z<sub>f</sub>. The short-circuit current is referred to as I<sub>cs</sub>. U<sub>oc</sub> is the no-load voltage of the generator.

**Critical Discharge Current i<sub>gg</sub>**

The critical discharge current is a current pulse of the waveform 8/20 µs which just about triggers the disconnection device and which does not yet lead to a mechanical damage of the arrester.

**Direct or Close-up Strikes**

Direct and close-up strikes cause surge voltages with an energy content that contains a considerable part of the total energy of a lightning discharge.

**Disconnection Device**

If an arrester fails to operate, the disconnection device separates it from the power grid to avoid a fire hazard and to report the defective arrester. Note: It is not the task of the disconnection device to ensure the protective measure Protection at indirect contact.

**Disturbance Voltage, symmetrical**

The symmetrical disturbance voltage is a disturbance voltage between two wires of a conductor (e.g. at a double-circuit line) or between the terminals of an electrical installation for such a line.

**Earth**

Earth signifies the ground or the soil.

**Earthing (noun)**

Earthing refers to the total of all means and measures for earthing.

**Earthing (verb)**

To earth means to connect a conductive part, e.g. the lightning protection installation, via an earth-termination system to the earth.

**Earthing Conductor**

The earthing conductor connects the installation which has to be earthed with the earthing electrode, as far as the earthing conductor runs above soil or insulated in the soil.

**Earthing Electrode**

An earthing electrode is a conductor buried into the ground with an electrically conductive connection to the earth. Parts of connectors that run to the earthing electrode which are lying non-insulated in the ground are part of the earthing electrode as well.

**Electromagnetic Compatibility (EMC)**

The electromagnetic compatibility of a device or a system is its capability of a satisfactory operation in its electromagnetic environment, without causing unacceptable electromagnetic disturbances to other installations in this environment.

**Electromagnetic Interference**

The electromagnetic interference refers to a quality loss in operational behaviour, a malfunction or the breakdown of an electrical or electronically device caused by an electromagnetic disturbance.

**Electrostatic Discharge (e.s.d.)**

An electrostatic discharge is the transfer of electric charges between objects with different electrostatic potentials, which takes place at approximation or contact.

**Endurance Test**

In an endurance test the surge arrester has to undergo load tests, that simulate loads frequently occurring in practice.

**Equipotential Bonding (Potential Equalization)**

Potential equalization means to remove potential differences (at the operation of consumer’s electrical installations), e.g. between the protective conductor of the electrical power installation and the pipes for the water, gas and heating supply, as well as between the individual pipes.

The equipotential bonding at lightning effects requires measures beyond the specifications of VDE 0190. Therefore, the lightning protection installation is connected to other conductive installations via conductors or isolation spark gaps and, if necessary, to active parts of electrical installations via surge protection devices. These measures are called “lightning protection potential equalization”.

**Equipotential Bonding Bar**

This bar connects protective conductors, potential equalization conductors and, where applicable, functional earthing conductors with the earthing conductor and the earth electrodes.



## Follow-on Current $I_f$

The follow-on current flows through the SPD after the diverting process. It is supplied from the grid and differs fundamentally from the continuous operating current.

## Foundation Earthing Electrode

The foundation earthing electrode is a conductor that is embedded into the concrete foundation of a construction.

## Gas-filled Surge Arrester (GDT)

A gas-filled surge arrester is a discharge path filled with another gas than air, normally rare gas.

## Ground Resistance

The ground resistance is the resistance between the earthing system and the reference earth. The amount of the ground resistance depends on the interaction of the individual earthing electrodes.

## Impulse Current (8/20)

This impulse current has a front time of  $8 \mu\text{s}$  and a time to half-value of  $20 \mu\text{s}$ .

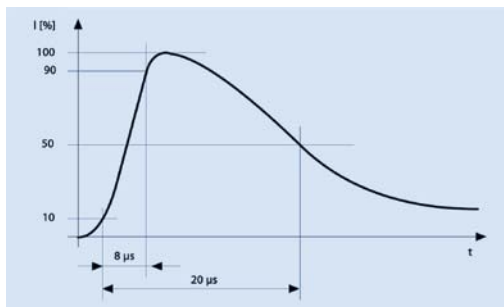

## Impulse Discharge Current

Discharge current that flows through the arrester after it is triggered. It is given as a peak value. The nominal impulse discharge current is the peak value of an impulse current of the pulse form 8/20  $\mu\text{s}$ .

## Impulse Sparkover Voltage of a Surge Protection Device

Highest voltage value between the electrodes of the spark gap of a surge protection device, just before the sparkover occurs.

## Impulse Voltage (1.2/50)

This impulse voltage has a front time (between 10 % and 90 % of its peak value) of  $1,2 \mu\text{s}$  and a time to half-value of  $50 \mu\text{s}$  (at  $U_{oc} = 6 \text{ kV}$ ).

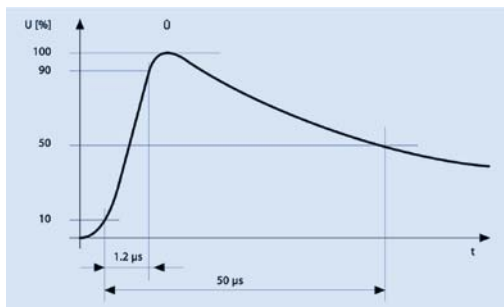

## Impulse Withstand Voltage $U_{St}$

The impulse withstand voltage is the peak value of the highest pulse voltage of a predefined waveform and polarity, which does not result in a breakdown under predefined test conditions. The impulse withstand voltage is equal to or higher as the rated impulse withstand voltage.

## Insertion Loss

The insertion loss of an SPD is, at a given frequency, the ratio of the voltages at a supply network point immediately downstream to the SPD before and after the insertion of this SPD. The value is given in decibel.

## Insulation Resistance $R_{iso}$

The insulation resistance is the resistance of the surge arrester in the non-conductive state.

## Interference Suppression

Interference suppression comprises all measures to abate or avoid electromagnetic interferences.

## Isolation Spark Gap

The isolation spark gap is a spark gap to isolate conductive parts of an installation. When the spark gap is triggered by a lightning strike, the parts are temporarily conducted (lightning-protection equipotential bonding).

## Lightning Current Arrester

The lightning current arrester is a surge-voltage protection device which is capable of carrying direct lightning currents.

## Lightning Impulse Current Discharge (Lightning Impulse Current)

The 10/350  $\mu\text{s}$  lightning impulse current has a front time of  $10 \mu\text{s}$  and a time to half-value of  $350 \mu\text{s}$ .

## Lightning Impulse Current $I_{imp}$

The lightning impulse current  $I_{imp}$  is defined by its peak value  $I_{max}$ , its charge  $Q$  and the specific energy  $W/R$  with a 10/350  $\mu\text{s}$  waveform. The test is carried out according to the test procedure of the operation duty test. It is used to classify the test for class I surge protection devices.

## Lightning Protection Installation

The lightning protection installation is the sum of all equipment for the external and internal lightning protection of the installation to be protected.

## Lightning Surge Voltage

The lightning surge voltage is a surge voltage caused by a lightning discharge.

## Longitudinal Voltage Drop

The longitudinal voltage drop is a means (instead of the insertion loss) to evaluate overvoltage arresters for d.c. voltages or low operating frequencies up to a maximum of 400 Hz. The longitudinal voltage drop is measured along the current path or paths at nominal current and, where applicable, operating frequency.

## Main Supply Short-Circuit Current $I_k$

The main supply short-circuit current is the short-circuit current which results from the impedance of the test network and the connecting cables at the installation point of the test object.

## Measured Limiting Voltage

Maximum voltage that is measured at the terminals of an SPD while pulses with a preset form and amplitude are applied.

## Nominal Alternating Discharge Current $I_{wn}$

The nominal alternating discharge current is the alternating current with frequencies between 15 and 62 Hz (primarily 50 Hz), which the test object is dimensioned for in a specific test procedure.



### Nominal Impulse Discharge Current $I_n$

The nominal impulse discharge current is the peak value of a current with the waveform 8/20 that flows through a surge protection device. It is used to classify the test for class II surge protection devices.

### Nominal Load Current $I_L$

The nominal load current is the maximum continuous, alternating or direct current which can flow from the output of an SPD to the connected load.

### Nominal Voltage $U_N$

The nominal voltage, as a rounded voltage value, specified by the manufacturer of an electrical apparatus to identify it and to specify the voltage range for which it is designed.

### Overvoltage Category

The overvoltage category is the classification of a piece of electrical equipment to the expected overvoltages.

### Potential Equalization Conductor

The potential equalization conductor is a conductive link to achieve potential equalization.

### Potential Equalization Installation

The potential equalization installation is the total of all interconnected potential equalization conductors, including all other conductive parts which work in the same way, e.g. housings or other conductive installations. The potential equalization installation can either be the earth-termination system or part of it.

### Power-Frequency Withstand Voltage

The power-frequency withstand voltage is the r.m.s. value of the highest sinusoidal voltage at system frequency, which does not result in a breakdown under predefined test conditions.

### Protection Level $U_p$

The protection level is a parameter which characterizes the performance of an SPD to limit the voltage between its terminals. The protection level is chosen from a list of standard values and has to exceed the highest value of the measured limiting voltages.

### Protection Path

The parts of an SPD can be connected as “conductor against conductor” or “neutral conductor against earth”, or a combination of these possibilities. These methods of connection are called protection paths.

### Pulse

A pulse is a rapid, temporary change of a physical parameter followed by a fast change back to the original value.

### Rate of Rise

The rate of rise is the average change rate of a parameter between two certain values, e.g. between 10 % and 90 % of the peak value.

### Rated Voltage of an Arrester $U_C$

Maximum acceptable root-mean-square value of the power-frequency a.c. voltage that can be permanently applied to the terminals of the arrester.

### Reference Earth

Reference earth is the reference ground (especially the earth's surface) that is so far apart from the earthing electrodes that, if a current is diverted into the ground, no relevant voltage differences occur between the points of this area.

### Remote Signalling Contact

Remote signalling contacts belong to a circuit which is separated from the main circuit of the SPD. The disconnection device of the SPD and/or an operation indication are part of the same circuit.

### Remote Strikes

Remote strikes cause surges with a considerable smaller energy content compared to close-up strikes.

### Residual Current Protective Device (RCD)

Residual current protective devices disconnect the circuit if the residual current against earth exceeds a certain value.

### Residual Voltage $U_{res}$

The residual voltage is the peak value of the voltage that appears between the terminals of an SPD during the flow of a discharge current or immediately after it.

### SEMP

Switching operations are referred to with the abbreviation SEMP. This stands for switching electromagnetic pulse.

In this context, switching operations mean the switching of powerful machines or short circuits in the power supply network. During such operations, significant current changes occur in the affected cables in a split second.

### Short-circuit Withstand Capability

The short-circuit withstand capability is the highest unaffected short-circuit current the surge protection device can withstand.

### Sparkover Voltage

The sparkover voltage is the highest instantaneous value of the voltage at the terminals of an arrester, just before it is triggered.

### Specialist in Lightning Protection

A specialist in lightning protection has a professional training, knowledge and expertise as well as knowledge of the corresponding regulations that allow him to assess the work assigned to him as well as to identify possible dangers. (To judge the professional training, one can also consider several years of working in the corresponding field.)

### Status Display

The status display indicates the state of operation of an SPD.

### Surge Voltage

A surge voltage is a voltage that puts people and/or technical equipment like conductors and devices at risk. It can permanently (overvoltage) or temporarily (surge voltage) occur between conductor and earth in error-free installations (in disconnected conductors as well).

### Surge Protection Device (SPD)

A surge-voltage protection device limits transient surges and diverts impulse currents. It includes at least one non-linear component.

### Temperature Range

The temperature range describes the lowest and highest temperatures that are allowed at or inside the housing. For devices without self-heating this range refers to the ambient temperature. For devices with self-heating it indicates the maximum operating temperature range.

### TOV Characteristics

The TOV characteristics describe the behaviour of an SPD to which a temporary overvoltage (TOV) is applied for a certain period of time.



## Transient

A transient is a non-periodic and very short positive or negative change of voltage or current between two steady states.

## transient

A transient behaviour describes the behaviour of a phenomenon or value which changes between two consecutive steady states in a very short time in comparison to the considered timescale.

## Transverse Voltage

The transverse voltage is the interference voltage which occurs between two conductors of the same circuit.

## Triggering Current of the Disconnection Device

The triggering current of the disconnection device is the root-mean-square value of the current through the arrester, which causes the disconnection device to operate within 30 seconds.

## Triggering

Triggering is referred to, if either the peak value of the ohmic component of the current through the arrester reaches 5 mA or a voltage drop caused by the rise of the peak value of the current through the arrester exceeds 5 mA.

## Varistors

A varistor is a bipolar non-linear resistor with symmetrical voltage-current characteristics. Its resistance decreases with increasing voltage.

## Withstand Voltage

The withstand voltage is the maximum voltage that can be applied to a current-limiting component of an SPD without affecting it. This voltage can be equal to the highest continuous operating voltage  $U_c$  of the SPD or higher, depending on the components inside the SPD.

## Abbreviations

<b>ATEX</b>	Atmosphères Explosibles
<b>CCP</b>	Cathodic Corrosion Protection
<b>CCPS</b>	Cathodic Corrosion Protection System
<b>EAC</b>	Eurasian Conformity
<b>EBS</b>	Equipotential Bonding Strip
<b>ESD</b>	Electrostatic Discharge
<b>FM</b>	Remote Signalling Contact (Changeover Contact)
<b>FS</b>	Fail-safe
<b>GDT</b>	Gas-Filled Surge Arrester
<b>LEMP</b>	Lightning Electromagnetic Impulse
<b>LPL</b>	Lightning Protection Level
<b>LPMS</b>	LEMP Protection Measures System
<b>LPS</b>	Lightning Protection System
<b>LPZ</b>	Lightning Protection Zone
<b>MOV</b>	Metalloxyd Varistor
<b>Pk</b>	Potential-free Contact (Break Contact)
<b>RCD</b>	Residual Current Device
<b>SEMP</b>	Switching Electromagnetic Pulse
<b>SPD</b>	Surge Protective Device
<b>TAB</b>	Technical Connection Requirements for Electrical Power Installations
<b>TOV</b>	Temporary Overvoltage
<b>VDEW</b>	Vereinigung deutscher Elektrizitätswerke e.V. (German Association for the Power Supply Industry)
<b>VdS</b>	Verband der Sachversicherer (Property Insurer Association)

## Surge voltages can get into circuits in various ways. These are known as coupling types.

### 1. Galvanic coupling

This refers to surge voltages which are directly coupled into a circuit. This can be observed during lightning strikes, for example. In this case, lightning current amplitudes at the grounding resistance of the affected building cause a surge voltage.

This voltage affects all cables that are connected to the central equipotential bonding. A surge voltage also occurs along conductors carrying lightning current. Due to the fast current increase rate, this can mainly be traced back to the inductive component of the cable resistance. Faraday's law of induction is used as the basis for calculating this:  $u_0 = L \times di/dt$ .

### 2. Inductive coupling

This process occurs through the magnetic field of another current-carrying conductor, following the transformer principle. A directly coupled surge voltage causes a surge current with a high rate of increase in the affected conductor.

At the same time, a strong magnetic field is created around this conductor, as is the case in the primary winding of a transformer. The magnetic field induces a surge voltage in other cables in its vicinity, as is the case in the secondary winding of a transformer. The coupled surge voltage is channeled along the cables into the connected device.

### 3. Capacitive coupling

This type of coupling primarily occurs via the electric field between two points with a large potential difference. A high potential occurs via the down conductor of a lightning arrester due to a lightning strike. An electrical field is created between the down conductor and other parts with a low potential.

These may be, for example, cables for power supply and signal transmission or devices inside the building. The charge is transferred through the electrical field. This leads to a voltage increase or ultimately a surge voltage in the affected cables and devices.

---

**Leutron GmbH** is registered in Zentrale Stelle Verpackungsregister (Central Agency Packaging Register) with register number DE5872258993777 since January 1<sup>st</sup> 2019.  
[www.verpackungsregister.org](http://www.verpackungsregister.org)

## CE Marking

CE marking is a certification mark that indicates conformity with health, safety, and environmental protection standards for products sold within the European Economic Area (EEA).



Art.-No.	Product name	Page	Art.-No.	Product name	Page	Art.-No.	Product name	Page
04 00 01	AntPro Koax-GSM-N/230	168	24 00 17	DP 2-2MB-Tr	190	24 01 37	LSA DIN ADAPT	161
04 00 04	AntPro Koax-GSM-N/230(f/f)	168	24 00 18	DataPro 2x1-SDSL-Tr	127	24 01 42	DP 10LSA-PTC-110	160
04 00 10	AntPro 6GHz-N(m/f)	169	24 00 20	DataPro 4x1-SDSL-Tr	127	24 01 54	TelPro LSA-2EL90-20kA	151
04 00 11	AntPro 6GHz-N(f/f)	169	24 00 21	DP 1xRJ45-PoE-Alu	145	24 01 56	TelPro LSA-2EL350-20kA	151
04 58 00	AntPro 5,8GHz-SMA	167	24 00 24	DP 2x1-24V-SDSL-Tr	127	24 12 00	EnerPro 12V-Tr	82
04 58 02	AntPro 5,8GHz-R-SMA	167	24 00 26	DP 10LSA-PTC-12V	160	24 12 02	EnerPro 12V-6A/LED	80
10 10 00	DP Koax 7/16	170	24 00 28	DP 10LSA-PTC-24V	160	24 12 03	EP 12V-20A/LED	81
10 10 01	DP Koax 7/16 (f/f)	170	24 00 31	DP 1LSA-5	154	24 24 00	EnerPro 24V-Tr	82
16 02 00	H45	199	24 00 32	DP 1LSA-12	154	24 24 02	EnerPro 24V-6A/LED	80
16 05 20	DP FME-AD	167	24 00 33	DP 1LSA-15	154	24 24 03	EP 24V-20A/LED	81
17 00 13	KA 1TE-1/3	97	24 00 34	DP 1LSA-24	154	24 36 00	EnerPro 36V-Tr	82
17 00 15	KA 1TE-1/2	97	24 00 38	DP 1LSA-60	155	24 36 02	EnerPro 36V-6A/LED	80
17 00 25	KA 1TE-1/4	97	24 00 39	DP 1LSA-110	155	24 36 03	EP 36V-20A/LED	81
17 00 31	KA 1TE-1/6	97	24 00 40	DP 1LSA-5-PTC	156	24 48 00	EnerPro 48V-Tr	82
17 00 35	KA 2TE-1/3	97	24 00 41	DP 1LSA-12-PTC	156	24 48 03	EP 48V-20A/LED	81
17 00 41	KA 2TE-1/4	97	24 00 43	DP 1LSA-24-PTC	156	24 60 00	EnerPro 60V-Tr	83
17 00 42	KA 1TE-1/8	97	24 00 44	DP 1LSA-48-PTC	157	25 30 09	EPF 230V/16A-Tr2-FM	177
17 00 80	Erdbrücke	127	24 00 45	DP 1LSA-60-PTC	157	25 30 11	EPF 230V/25A-Tr2-FM	177
17 01 00	AK35 GDT230	98	24 00 46	DP 1LSA-110-PTC	157	25 30 19	EPF 48V/16A-S	178
17 01 10	DAK 2x 16	248	24 00 48	DP 1LSA-T110FS-PTC	157	25 30 20	EPF 230V/16A-S	178
17 01 40	E-Membran M12	248	24 00 49	DP 1LSA-TK180FS	159	25 30 22	EPF 60V/16A-S	178
17 01 51	ST-Si/4A	248	24 00 60	DP RS 232/422/485-9P	149	25 30 25	EPF 230V/16A-W	179
17 01 52	ST-Si/8A	248	24 00 61	DP 1LSA-C48FS-PTC	159	25 30 45	EPF 230/400V/16A-W	180
17 01 53	ST-Si/10A	248	24 00 62	DP 1LSA-C60FS-PTC	159	25 30 53	EPF 48V/25A-S	178
17 01 54	ST-Si/12A	248	24 00 63	DP 1LSA-C5FS-PTC	158	25 30 80	EPF 230/400V/25A-W	180
17 01 56	ST-Si/20A	248	24 00 64	DP 1LSA-C12FS-PTC	158	25 30 85	EPF 230V/35A-S	179
17 01 66	MW-AntPro	168	24 00 65	DP 1LSA-C15FS-PTC	158	25 31 00	EPF 230/400V/35A-W	180
17 01 80	DP-SAT-EB5	171	24 00 66	DP 1LSA-C24FS-PTC	158	25 31 30	EPF 230/400V/63A-E	181
19 40 13	DP 1x8RJ45-19"	147	24 01 00	LSA 2/10-AN	161	25 31 40	EPF 230/400V/100A-E	181
19 40 23	DP 2x8RJ45-19"	147	24 01 02	LSA 2/10-TR	161	25 31 60	EPF 230/400V/200A-E	181
19 40 33	DP 3x8RJ45-19"	147	24 01 04	LSA 2/10-ER38-rot	161	26 12 12	DP 2x1-12V/12V-0.3Ω-Tr	187
19 40 43	DP 4x8RJ45-19"	147	24 01 06	TelPro LSA 2/10-2E 8x6	151	26 24 24	DP 2x1-24V/24V-0.3Ω-Tr	187
19 40 50	DP 8xRJ45-6V-WG	146	24 01 08	LSA 2/10 KSR	161	26 30 30	DP 2x1-30V/30V-0.3Ω-Tr	187
19 40 51	DP 8xRJ45-6x6V/2x48V-WG	146	24 01 09	LSA 2/10 AD	161	26 36 36	DP 2x1-36V/36V-0.3Ω -Tr	187
19 40 53	DP 5x8RJ45-19"	148	24 01 10	LSA 2/10-MW/10-25/22	161	26 60 60	DP 2x1-60V/60V-0.3Ω-Tr	188
19 40 63	DP 6x8RJ45-19"	148	24 01 13	TelPro LSA-2EH230-10kA	151	27 00 00	DP 2x1-RLC-Tr	189
21 00 10	DP-SAT-F-5...2500MHz	171	24 01 14	TelPro LSA-2EH230F-10kA	151	27 03 03	IsoProData 150V/150V-Tr	182
22 12 12	DataPro Z-12V/12V	192	24 01 15	TelPro LSA-2EL230-20kA	151	27 04 04-A	DP 2x1-150V/150V-Tr	184
22 15 15	DataPro Z-15V/15V	192	24 01 16	TelPro LSA-2EH350-10kA	151	27 04 85	DP RS485-Tr	126
22 24 24	DataPro Z-24V/24V	192	24 01 17	TelPro LSA-2EH90-10kA	151	27 06 06-A	DP 2x1-6V/6V-Tr	183
22 30 30	DataPro Z-30V/30V	192	24 01 18	TelPro LSA 2/10-3E 8x13	152	27 12 12-A	DP 2x1-12V/12V-Tr	183
22 36 36	DataPro Z-36V/36V	193	24 01 19	TelPro LSA 2/10-3EH230E-10kA	152	27 15 15-A	DP 2x1-15V/15V-Tr	183
22 48 48	DataPro Z-48V/48V	193	24 01 23	TelPro LSA-3EH230F1E-10kA	152	27 24 24-A	DP 2x1-24V/24V-Tr	183
22 60 60	DataPro Z-60V/60V	193	24 01 24	TelPro LSA-3EL230E-20kA	152	27 30 02	IsoProData-Tr	128
23 90 00	DP RJ45-48V-Tr	143	24 01 25	TelPro LSA-3EL230F1E-20kA	152	27 30 30-A	DP 2x1-30V/30V-Tr	184
23 90 06	DP RJ11/RJ12-48V-Tr	144	24 01 26	TelPro LSA-3EH90E-10kA	152	27 36 36-A	DP 2x1-36V/36V-Tr	184
24 00 04	DataPro-TAE/NFN-aP	149	24 01 27	TelPro LSA-3EH90F1E-10kA	152	27 48 48-A	DP 2x1-48V/48V-Tr	184
24 00 05	DP RJ45-CAT6-48V-Tr	143	24 01 33	LSA 2/10-ES	161	27 60 60-A	DP 2x1-60V/60V-Tr	184
24 00 11	DP RJ45 f/f	144	24 01 36	LSA 2/10 KS-120	161	27 80 80-A	DP 2x1-80V/80V-Tr	184



# PRODUCT REGISTER

## NUMERIC

Art.-No.	Product name	Page	Art.-No.	Product name	Page	Art.-No.	Product name	Page
27 90 00	DP 2x8-36V/36V-Tr/GO	191	37 39 72	PP B TNC 50/100/FM	19	38 11 35	PP BCD TT1+1 25/100/FM	28
27 90 01	DP 2x8-36V/36V-Tr/GU	191	37 39 82	PP BC TNC 25/75/FM	23	38 11 41	IP B TNC 60/100/FM	35
28 04 04-A	DP 3x1-150V/150V-Tr	186	37 39 83	PP BC TNC 440/FM	24	38 11 43	IP BC TNC 60/100/FM	39
28 12 12-A	DP 3x1-12V/12V-Tr	185	37 39 85	PP BCD IT-NO 25/75/FM	28	38 11 46	IP B TNS 60/100/FM	34
28 15 15-A	DP 3x1-15V/15V-Tr	185	37 39 92	PP BCD TNC 25/75/FM	27	38 11 48	IP BC TNS 60/100/FM	37
28 24 24-A	DP 3x1-24V/24V-Tr	185	37 41 15	PP B TNC 50/100/FM-350	20	38 11 51	IP B TT 60/100/FM	34
28 30 30-A	DP 3x1-30V/30V-Tr	185	37 41 25	PP B TNS 50/100/FM-350	18	38 11 54	IP BC TT 60/100/FM	38
28 36 36-A	DP 3x1-36V/36V-Tr	186	37 41 35	PP B TT 50/100/FM-350	19	38 11 56	IP B TT1+1 60/100/FM	35
28 48 48-A	DP 3x1-48V/48V-Tr	186	37 44 01	PP PV 800/FM	92	38 11 58	IP BC TT1+1 60/100/FM	40
28 60 60-A	DP 3x1-60V/60V-Tr	186	37 44 03	PP PV 1000/FM	92	38 11 63	IP BC TT 60/100-LED/FM	44
28 70 50	DP 2x1-RLC/50V-Tr	189	37 44 05	PP PV 1000-12,5kA-FM	92	38 11 77	EP C TNC 275/FM	61
29 60 02	EnerPro 65V/12A-Tr/FM	231	37 45 01	PP BC 50-440/FM	25	38 11 79	EP C TNS 275/FM	61
29 60 11	EnerPro 65V/20A-Tr/FM	231	37 45 05	PP BC TNC 50-400/690/FM	25	38 11 81	EP C TT 275/FM	62
32 50 45	CPS-F 230/RJ45/RJ11	77	37 45 21	PP B 25-760/FM	21	38 11 83	EP C TT1+1 275/FM	62
35 10 30	UAS 230-Tr	97	37 70 01	PP B 50-520/FM	21	38 11 91	EP C TT1+1 350/FM	62
36 05 22	NM 220V/5kA	75	38 00 13	CT-T3/24V-16A-FM	67	38 12 09	PP BCD TN 25/50-LED-M/FM	33
36 20 23	NM 220V/20kA/Pk	75	38 00 14	CT-T3/24V-25A-FM	68	38 12 11	PP B TN 50/100/FM	20
36 20 40	EP-T3/230 SDU	77	38 00 16	CT-T3/48V-16A-FM	67	38 12 13	PP BC TN 25/50/FM	24
36 20 41	EP-T3/230 KM-10kA	76	38 00 17	CT-T3/48V-25A-FM	68	38 12 15	PP BCD TN 25/50/FM	27
36 20 42	EP-T3/230 KM-20kA	76	38 00 19	CT-T3/60V-16A-FM	67	38 12 17	IP B TNC 25/75/FM	35
36 20 43	EP-T3/230 KM-10kA-v	76	38 00 20	CT-T3/60V-25A-FM	68	38 12 19	IP BC TNC 25/75/FM	39
36 20 44	EP-T3/230 KM-20kA-v	76	38 00 22	CT-T3/120V-16A-FM	67	38 12 21	IP B TNS 25/100/FM	34
37 12 02	PP BCD TN 25/50/LED/FM	32	38 00 23	CT-T3/120V-25A-FM	68	38 12 23	IP BC TNS 25/100/FM	37
37 38 24	SP BC NPE 100/FM	46	38 00 25	CT-T3/230V-16A-FM	68	38 12 25	IP B TT 25/100/FM	34
37 38 26	IP BC 25/FM	42	38 00 26	CT-T3/230V-25A-FM	68	38 12 27	IP BC TT 25/100/FM	38
37 38 40	PowerPro B-Tr/50kA/Pk	21	38 00 28	CT-T3/275V-16A-FM	68	38 12 29	IP B TT1+1 25/50/FM	35
37 38 49	PP BCD-Tr/25kA-LED/FM	33	38 00 29	CT-T3/275V-25A-FM	68	38 12 31	IP BC TT1+1 25/100/FM	40
37 38 60	PP BCD-Tr/25kA/Pk	29	38 05 25	EP D TNC 275/FM	69	38 12 33	IP B TN 60/100/FM	36
37 38 61	PP BCD-Tr/25kA-VA/FM	31	38 05 31	EP D TNS 275/FM	69	38 12 35	IP BC TN 60/100/FM	41
37 38 62	PP BCD-Tr/25kA/FM-350	29	38 05 36	EP D TT 275/FM	69	38 12 37	IP B TN 25/50/FM	36
37 38 65	PP BCD 27kA/FM	30	38 05 39	EP D TT1+1 275/FM	69	38 12 39	IP BC TN 25/50/FM	41
37 38 68	PP BCD 27kA/FM-350	30	38 05 41	EP D TT2+1 275/FM	70	38 12 48	EP C TN 275/FM	63
37 38 85	PP B 50-350/FM	21	38 05 48	EP D TN 275V/25A-FM	73	38 12 52	EP C TN 275-D	63
37 38 89	PP BCD 25-350/FM	29	38 05 51	EP D TN 24V/16A/FM	71	38 12 55	EP D TN 275/FM	72
37 39 12	PP B TT 50/100/FM	18	38 05 54	EP D TN 48V/16A/FM	71	38 14 05	EP C TN 75/FM	63
37 39 17	PP B TT2+1 50/100/FM	19	38 05 55	EP D TN 24V/25A-FM	72	38 15 01	EP C IT 2P/FM	64
37 39 19	PP B IT 50/100/FM	21	38 05 57	EP D TN 60V/16A/FM	71	38 15 11	EP C IT 3P/FM	64
37 39 22	PP BC TT 25/100/FM	22	38 05 58	EP D TN 48V/25A-FM	72	38 16 81	LT ZP ST T1+2+3/3+1-275-12.5kA	48
37 39 32	PP BCD TT 25/100/FM	26	38 05 60	EP D TN 120V/16A/FM	71	38 16 82	LT ZP ST T1+2+3/3+1-275-7.5kA	48
37 39 36	PP BCD TT2+1 25/100/FM	28	38 05 63	EP D TN 230V/16A/FM	72	38 20 23	EnerPro 220Tr/20kA/PK	74
37 39 42	PP B TNS 50/100/FM	18	38 05 65	EP D TN 60V/25A-FM	73	38 20 25	EnerPro 150Tr/Pk	66
37 39 44	PP B TNS 440/FM	18	38 05 67	EP D TN 120V/25A-FM	73	38 20 29	EnerPro 280Tr/Pk	65
37 39 46	PP B TN 440/FM	20	38 05 69	EP D TN 230V/25A-FM	73	38 20 43	EnerPro 284Tr-M/Pk	66
37 39 52	PP BC TNS 25/100/FM	22	38 05 71	EP D IT 2P/FM	70	38 20 45	EnerPro 282Tr-M/Pk	65
37 39 55	PP BCD IT 2P 25/50-440/FM	29	38 06 11	EP-T2/220VDC-16A-FM	84	38 20 71	EnerPro 48V/100A-Tr/Pk	79
37 39 57	PP BCD TNC 75/LED/FM	32	38 07 01	EPS T1+2/3+1-320-12.5-FM	45	38 20 76	EnerPro 60V/100A-Tr/Pk	79
37 39 59	PP BCD TT 100/LED/FM	32	38 07 03	EPS T1+2/4+0-320-12.5-FM	45	38 20 79	EP CV 2P 65V/63A/FM	230
37 39 62	PP BCD TNS 25/100/FM	26	38 11 31	PP B TT1+1 50/100/FM	19	38 20 83	EP CV 2P 65V/63A/FM-LED	230
37 39 65	PP B TNC 440/FM	20	38 11 33	PP BC TT1+1 25/100/FM	23	38 20 87	EP CV 2P 100V/63A/FM-LED	230



Art.-No.	Product name	Page
38 20 89	EP CV 2P 100V/63A/FM	230
38 50 10	PP BCD TNC 25/75/FM-350	27
38 50 30	PP BCD TNS 25/100/FM-350	26
38 50 50	PP BCD TT 25/100/FM-350	26
38 50 70	PP BCD TN 25/50/FM-350	27
38 50 90	PP BCD TT1+1 25/100/FM-350	28
38 51 10	PP BCD TN 25/50/LED/FM-350	32
38 51 30	PP BC TNC 25/75/FM-350	23
38 51 50	PP BC TNS 25/100/FM-350	22
38 51 70	PP BC TT 25/100/FM-350	22
38 51 90	PP BC TN 25/50/FM-350	24
38 52 10	PP BC TT1+1 25/100/FM-350	23
38 52 90	IP BC TNC 60/100/FM-350	39
38 53 10	IP BC TNC 25/75/FM-350	39
38 53 30	IP BC TNS 60/100/FM-350	37
38 53 50	IP BC TNS 25/100/FM-350	37
38 53 70	IP BC TT 60/100/FM-350	38
38 53 90	IP BC TT 25/100/FM-350	38
38 54 10	IP BC TN 60/100/FM-350	41
38 54 30	IP BC TN 25/50/FM-350	41
38 54 50	IP BC TT1+1 60/100/FM-350	40
38 54 70	IP BC TT1+1 25/100/FM-350	40
38 55 50	EP C TN 350/FM	63
38 55 70	EP C TNC 350/FM	61
38 55 90	EP C TNS 350/FM	61
38 56 10	EP C TT 350/FM	62
38 80 00	EL-T2-75-M	60
38 80 01	EL-T2-130-M	60
38 80 02	EL-T2-275-M	60
38 80 03	EL-T2-350-M	60
38 80 04	EL-T2-440-M	60
38 80 05	EL-T2-550-M	60
38 80 06	EL-T2-750-M	60
38 80 07	EL-T2-NPE-M	60
38 81 01	EL-T2/4+0-130-FM	52
38 81 02	EL-T2/4+0-275-FM	52
38 81 03	EL-T2/4+0-350-FM	52
38 81 04	EL-T2/4+0-440-FM	52
38 81 15	EL-T2/3+1-130-FM	53
38 81 16	EL-T2/3+1-275-FM	53
38 81 17	EL-T2/3+1-350-FM	53
38 81 18	EL-T2/3+1-440-FM	53
38 81 29	EL-T2/3+0-130-FM	54
38 81 30	EL-T2/3+0-275-FM	54
38 81 31	EL-T2/3+0-350-FM	54
38 81 32	EL-T2/3+0-440-FM	54
38 81 42	EL-T2/2+1-75-FM	55
38 81 43	EL-T2/2+1-130-FM	55
38 81 44	EL-T2/2+1-275-FM	55

Art.-No.	Product name	Page
38 81 45	EL-T2/2+1-350-FM	55
38 81 46	EL-T2/2+1-440-FM	56
38 81 47	EL-T2/2+1-550-FM	56
38 81 57	EL-T2/2+0-130-FM	56
38 81 58	EL-T2/2+0-275-FM	56
38 81 59	EL-T2/2+0-350-FM	57
38 81 60	EL-T2/2+0-440-FM	57
38 81 71	EL-T2/1+1-130-FM	57
38 81 72	EL-T2/1+1-275-FM	57
38 81 73	EL-T2/1+1-350-FM	58
38 81 74	EL-T2/1+1-440-FM	58
38 81 84	EL-T2/1+0-75-FM	58
38 81 85	EL-T2/1+0-130-FM	58
38 81 86	EL-T2/1+0-275-FM	59
38 81 87	EL-T2/1+0-350-FM	59
38 81 88	EL-T2/1+0-440-FM	59
38 81 89	EL-T2/1+0-550-FM	59
38 81 90	EL-T2/1+0-750-FM	60
38 81 98	EL-T2/0+1-NPE	60
39 50 02	EnerPro 1002Tr	96
39 50 03	EP 1003Tr	95
39 50 05	EnerPro 802Tr/Pk	96
39 50 14	EP 802/20kA-Tr	96
39 50 16	EP 1002/20kA-Tr	96
39 50 26	EP 803Tr	95
44 90 60	TSF 50	209
44 90 69	TSF 100	209
44 90 76	TSF 50-Tr	219
44 90 80	TSF 100-Tr	219
44 90 85	TSF 500-Tr	219
44 91 50	TSF 100 H1	209
44 91 75	TSF-H1	209
47 21 04	SGO 70 QA	212
47 21 11	SGO 350 QA	212
47 21 17	SGO 70	211
47 22 13	SGO 350	211
48 78 01	TSF 500	209
48 78 07	HSCS-100-FM	213
48 78 08	HSCS-500-FM	213
48 78 14	TA 100C	210
48 78 27	TA 500C	210
48 78 30	TC 100 A	214
48 78 50	TC 500 A	214
49 50 80	TC Acrylic hood	215
49 51 00	TC 100 A-K1/500	214
49 51 06	K1/150	214
49 51 07	TC 100 A-K1/300	214
49 51 08	K1/300	214
49 51 11	K1/600	214

Art.-No.	Product name	Page
53 43 72	TF 100Tr/Th-Pk	220
53 43 85	TF 500Tr/Th-Pk	220
54 43 30	DP Koax BNC 500hm	166
54 43 40	DataPro Koax-8V-BNC-75 Ohm	165
54 43 46	DataPro Koax-8V-BNC	165
54 43 57	DP-SMA-m/f	166
55 04 11	TF 2000Tr/Th-Pk	220
55 04 39	PLPro-40A-IV HSCS-500-FM	229
55 04 40	PLPro-40A-IV	229
55 04 41	PLPro-80A-IV	229
55 04 95	IP B 60/FM	36
55 05 00	IP B 25/FM	36
55 05 18	IP BC 60/FM	42
55 05 21	IP BC 60/FM-350	42
55 05 23	IP BC 60/FM-350 2kV	43
55 05 27	IP BC 25/FM-350 2kV	43
55 05 41	IP BC 60/FM-440	43
79 00 05	AK-T1/3+1-FM	49
79 00 15	AK-T1+2/3+1-FM	50
79 00 25	AK-T1+2+3/3+1-FM	51
79 00 40	AK-T1/3+0-FM	49
79 00 45	AK-T1+2/3+0-FM	50
79 00 50	AK-T1+2+3/3+0-FM	51
80 01 21	GAK 2+2/2+2/2xT2 800V-FM	237
80 01 23	GAK 2+2/2+2/2xT2 1000V-FM	237
80 01 31	GAK 2+2/2+2/2xT1+T2 800V-FM	237
80 01 33	GAK 3x1/3x1/3xT1+T2 1000V-FM	238
80 01 35	GAK 6x1/6x1/6xT1+T2 1000V-FM	238
80 01 41	PV DC 2.800-2-FM	237
80 01 43	PV AC-DC 1.1-800-FM	244
80 01 45	PV AC-DC 3.1-1000-FM	244
80 01 54	GAK 2+2/2+2/2xT1+T2 1000V-FM	244
80 01 56	GAK 8x2/8x2/8xT1+T2 1000V-FM	238
80 01 64	GAK 4x3/4xT1+T2 1000V-FM	238
80 01 67	GAK 2x2 1000V/30A	246
80 01 72	Fuse Combiner Box	246
80 01 76	PV DC 3.800-3-FM	238
80 01 77	PV DC 3.800-3-S2-FM	238
80 01 78	PV DC 8.800-8-FM	238
80 01 79	PV DC 1/1 1xT1+2 1000V/MC4-FM	245
80 01 80	GAK 9x1/9x1/9xT1+T2 1000V-FM	238
80 01 81	PV AC-DC 1.1-1000-FM	244
80 01 82	PV AC-DC 1.2-800-FM	244
80 01 83	PV AC-DC 3.3-1000-FM	244
80 01 84	GAK AC-3 T1+T2-FM	245
80 04 40	GAK 6x2 T1+T2 1000V-DSK-FM	239
80 04 41	GAK 4x2 T1+T2 1000V-DSK-FM	239
80 04 42	GAK 3x2 T1+T2 1000V-DSK-FM	239



# PRODUCT REGISTER

## NUMERIC

Art.-No.	Product name	Page	Art.-No.	Product name	Page	Art.-No.	Product name	Page
80 04 43	GAK 2x2 T1+T2 1000V-DSK-FM	239	96 00 11	CT-T1+2/1+0-350-FM	15	97 00 24	MP 1x2 GDT+170V-Ad-Ad ST	114
80 04 44	GAK 1x2 T1+T2 1000V-DSK-FM	239	96 02 07	CT-T1/3+1-350-FM	12	97 00 25	MP 2x2 GDT+5V-Ad-Pg ST	116
80 04 45	GAK 1x1 T1+T2 1000V-FM	242	96 02 09	CT-T1/3+0-350-FM	12	97 00 26	MP 2x2 GDT+12V-Ad-Pg ST	116
80 04 46	GAK 2x1 T1+T2 1000V-FM	243	96 02 11	CT-T1/2+1-350-FM	12	97 00 27	MP 2x2 GDT+24V-Ad-Pg ST	116
80 04 47	GAK 1x3 T1+T2 1000V-DSK-FM	240	96 02 13	CT-T1/2+0-350-FM	12	97 00 28	MP 2x2 GDT+36V-Ad-Pg ST	116
80 04 48	GAK 2x3 T1+T2 1000V-DSK-FM	240	96 02 15	CT-T1/1+1-350-FM	13	97 00 29	MP 2x2 GDT+48V-Ad-Pg ST	117
80 04 49	GAK 4x3 T1+T2 1000V-DSK-FM	240	96 02 17	CT-T1/1+0-350-FM	13	97 00 30	MP 2x2 GDT+60V-Ad-Pg ST	117
80 04 50	GAK 2x5 T1+T2 1000V-DSK-FM	241	96 02 21	CT PV-T2/2-0/600-FM	93	97 00 31	MP 2x2 GDT+170V-Ad-Pg ST	117
80 04 51	GAK 1x6 T1+T2 1000V-FM	242	96 02 23	CT PV-T2/2-0/1000-FM	93	97 00 32	MP 1x2 GDT+5V-Ad-Pg ST	117
80 04 52	GAK 2x3 T1+T2 1000V-FM	243	96 02 25	CT PV-T2/2+1/600-FM	93	97 00 33	MP 1x2 GDT+12V-Ad-Pg ST	117
80 04 53	GAK 2x4 T1+T2 1000V-FM	243	96 02 27	CT PV-T2/2+1/1000-FM	93	97 00 34	MP 1x2 GDT+24V-Ad-Pg ST	117
80 04 54	GAK 1x12 T1+T2 1000V-FM	242	96 02 29	CT PV-T2/2+GDT/600-FM	94	97 00 35	MP 1x2 GDT+36V-Ad-Pg ST	117
80 04 55	GAK 5x1 T1+T2 1000V-FM	241	96 02 31	CT PV-T2/2+GDT/1000-FM	94	97 00 36	MP 1x2 GDT+48V-Ad-Pg ST	118
80 05 70	PV AB 1000 1M	247	96 02 33	CT-T1/0+1-FS-FM	13	97 00 37	MP 1x2 GDT+60V-Ad-Pg ST	118
80 05 80	PV AB 1000 2M	247	96 02 36	CT-T1+2-350-M	15	97 00 38	MP 1x2 GDT+170V-Ad-Pg ST	118
82 30 10	IF1-10-W	218	96 02 37	CT-T1-350-M	13	97 00 39	MP 2x2 GDT+5V-Ad-Ad-Pg ST	119
82 30 11	IF1-22-W	218	96 02 38	CT-T1-NPE-M	13	97 00 40	MP 2x2 GDT+12V-Ad-Ad-Pg ST	119
82 30 12	IF1-16-W	218	96 02 46	CT PV-T2-600-M	94	97 00 41	MP 2x2 GDT+24V-Ad-Ad-Pg ST	119
82 30 15	IF3-18-F	218	96 02 47	CT PV-T2-1000-M	94	97 00 42	MP 2x2 GDT+36V-Ad-Ad-Pg ST	119
82 30 16	IF3-22-F	218	96 02 48	CT PV-T2-GDT-M	94	97 00 43	MP 2x2 GDT+48V-Ad-Ad-Pg ST	120
82 30 17	IF3-16-F	218	96 02 50	CT PV-T2-1000-MS	94	97 00 44	MP 2x2 GDT+60V-Ad-Ad-Pg ST	120
82 30 18	IF3-25-F	218	96 04 01	CT-T1+2+3/3+1-350-FM	16	97 00 45	MP 2x2 GDT+170V-Ad-Ad-Pg ST	120
82 30 19	IF1-23-W	218	96 04 05	CT-T1+2+3/3+0-350-FM	16	97 00 46	MP 1x2 GDT+5V-Ad-Ad-Pg ST	121
82 30 20	IF1-18-W	218	96 04 09	CT-T1+2+3/2+0-350-FM	16	97 00 47	MP 1x2 GDT+12V-Ad-Ad-Pg ST	121
82 30 21	IF1-42-W	218	96 04 13	CT-T1+2+3/2+1-350-FM	16	97 00 48	MP 1x2 GDT+24V-Ad-Ad-Pg ST	121
82 30 22	IF1-52-W	218	96 04 17	CT-T1+2+3/1+1-350-FM	17	97 00 49	MP 1x2 GDT+36V-Ad-Ad-Pg ST	121
82 30 24	IF1-19.8-W	218	96 04 21	CT-T1+2+3/1+0-350-FM	17	97 00 50	MP 1x2 GDT+48V-Ad-Ad-Pg ST	121
82 30 25	IF1-22.2-W	218	96 04 25	CT-T1+2+3-350-M	17	97 00 51	MP 1x2 GDT+60V-Ad-Ad-Pg ST	121
82 30 26	IF1-28.6-W	218	97 00 00	MP Base 2x2-R	112	97 00 52	MP 1x2 GDT+170V-Ad-Ad-Pg ST	121
82 30 27	IF1-32-W	218	97 00 01	MP Base 2x2-R GDT	112	97 00 57	MP 1x2 GDT+12V-Ad-Ad-FM	115
82 30 28	IF1-39-W	218	97 00 03	MP Base 2x2	111	97 00 58	MP 1x2 GDT+24V-Ad-Ad-FM	115
87 00 05	LC 1	98	97 00 04	MP Base 2x2 GDT	111	97 00 59	MP 1x2 GDT+36V-Ad-Ad-FM	115
87 00 10	H35	199	97 00 06	MP Base 1x2-R-FM	115	97 00 91	MP Base 2x2-R GND	116
87 00 60	GDT Adapter ADE/FGH	199	97 00 07	MP 2x2 GDT ST	111	97 00 92	MP Base 2x2 GND	111
87 00 70	Prüfadapter ADE/E	199	97 00 08	MP 2x2 GDT ST-350	111	97 00 93	MP Base 1x2-R GND	114
87 01 00	A46	200	97 00 10	MP 1x2 GDT ST	111	97 00 94	MP Base 1x2 GND	111
87 01 10	M10-Stoßstromgenerator	202	97 00 11	MP 2x2 GDT+5V-Ad-Ad ST	112	97 00 95	MP Base 1x2-R	114
87 01 40	Kalibrierung H35/H45/H65	199	97 00 12	MP 2x2 GDT+12V-Ad-Ad ST	112	97 00 96	MP Base 1x2-R GDT	114
87 01 50	H65	199	97 00 13	MP 2x2 GDT+24V-Ad-Ad ST	112	97 00 97	MP Base 1x2	111
87 01 60	MC6000	201	97 00 14	MP 2x2 GDT+36V-Ad-Ad ST	112	97 00 98	MP Base 1x2 GDT	111
95 15 00	MTH 90	153	97 00 15	MP 2x2 GDT+48V-Ad-Ad ST	113	97 00 99	MP Base 2x2-R HF	123
95 15 01	MTH 230	153	97 00 16	MP 2x2 GDT+60V-Ad-Ad ST	113	97 01 00	MP Base 2x2-R GDT HF	123
95 15 02	MTL 90	153	97 00 17	MP 2x2 GDT+170V-Ad-Ad ST	113	97 01 01	MP Base 2x2-R GND HF	123
95 15 03	MTL 230	153	97 00 18	MP 1x2 GDT+5V-Ad-Ad ST	113	97 01 02	MP Base 1x2-R HF	123
96 00 01	CT-T1+2/3+1-350-FM	14	97 00 19	MP 1x2 GDT+12V-Ad-Ad ST	113	97 01 03	MP Base 1x2-R GDT HF	123
96 00 03	CT-T1+2/3+0-350-FM	14	97 00 20	MP 1x2 GDT+24V-Ad-Ad ST	113	97 01 04	MP Base 1x2-R GND HF	123
96 00 05	CT-T1+2/2+1-350-FM	14	97 00 21	MP 1x2 GDT+36V-Ad-Ad ST	113	97 10 02	MP RK-AB	132
96 00 07	CT-T1+2/2+0-350-FM	14	97 00 22	MP 1x2 GDT+48V-Ad-Ad ST	114	97 10 03	MP RK GDT	128
96 00 09	CT-T1+2/1+1-350-FM	15	97 00 23	MP 1x2 GDT+60V-Ad-Ad ST	114	97 10 04	MP RK GDT+5V-Ad-Ad	130





Art.-No.	Product name	Page	Art.-No.	Product name	Page
97 10 05	MP RK GDT+12V-Ad-Ad	130	97 10 30	MP RK 60V-Ad-Ad	134
97 10 06	MP RK GDT+24V-Ad-Ad	130	97 10 31	MP RK 170V-Ad-Ad	134
97 10 07	MP RK GDT+36V-Ad-Ad	130	97 10 32	MP RK 5V-Ad-Pg	134
97 10 08	MP RK GDT+48V-Ad-Ad	131	97 10 33	MP RK 12V-Ad-Pg	134
97 10 09	MP RK GDT+60V-Ad-Ad	131	97 10 34	MP RK 24V-Ad-Pg	134
97 10 10	MP RK GDT+170V-Ad-Ad	131	97 10 35	MP RK 36V-Ad-Pg	134
97 10 11	MP RK GDT+5V-Ad-Pg	131	97 10 36	MP RK 48V-Ad-Pg	135
97 10 12	MP RK GDT+12V-Ad-Pg	131	97 10 37	MP RK 60V-Ad-Pg	135
97 10 13	MP RK GDT+24V-Ad-Pg	131	97 10 38	MP RK 170V-Ad-Pg	135
97 10 14	MP RK GDT+36V-Ad-Pg	131	97 10 39	MP RK 5V-Ad-Ad-Pg	135
97 10 15	MP RK GDT+48V-Ad-Pg	132	97 10 40	MP RK 12V-Ad-Ad-Pg	135
97 10 16	MP RK GDT+60V-Ad-Pg	132	97 10 41	MP RK 24V-Ad-Ad-Pg	135
97 10 17	MP RK GDT+170V-Ad-Pg	132	97 10 42	MP RK 36V-Ad-Ad-Pg	135
97 10 18	MP RK GDT+5V-Ad-Ad-Pg	129	97 10 43	MP RK 48V-Ad-Ad-Pg	136
97 10 19	MP RK GDT+12V-Ad-Ad-Pg	129	97 10 44	MP RK 60V-Ad-Ad-Pg	136
97 10 20	MP RK GDT+24V-Ad-Ad-Pg	129	97 10 45	MP RK 170V-Ad-Ad-Pg	136
97 10 21	MP RK GDT+36V-Ad-Ad-Pg	129	97 10 50	MP 2x2 5V-HF ST	123
97 10 22	MP RK GDT+48V-Ad-Ad-Pg	130	97 10 51	MP 2x2 24V-HF ST	123
97 10 23	MP RK GDT+60V-Ad-Ad-Pg	130	97 10 52	MP 1x2 5V-HF ST	123
97 10 24	MP RK GDT+170V-Ad-Ad-Pg	130	97 10 53	MP 1x2 24V-HF ST	123
97 10 25	MP RK 5V-Ad-Ad	133	97 10 54	MP 2x2 5V-170-HF ST	124
97 10 26	MP RK 12V-Ad-Ad	133	97 10 55	MP 2x2 24V-170-HF ST	124
97 10 27	MP RK 24V-Ad-Ad	133	97 10 56	MP 1x2 5V-170-HF ST	124
97 10 28	MP RK 36V-Ad-Ad	133	97 10 57	MP 1x2 24V-170-HF ST	124
97 10 29	MP RK 48V-Ad-Ad	134	97 20 11	MSR-M20-24V	137



# PRODUCT REGISTER

## ALPHABETICAL

Product name	Art.-No.	Page	Product name	Art.-No.	Page	Product name	Art.-No.	Page
A46	87 01 00	200	CT-T3/120V-25A-FM	38 00 23	68	DP 2-2MB-Tr	24 00 17	190
AK35 GDT230	17 01 00	98	CT-T3/230V-16A-FM	38 00 25	68	DP 2x1-12V/12V-0.3Ω-Tr	26 12 12	187
AK-T1/3+0-FM	79 00 40	49	CT-T3/230V-25A-FM	38 00 26	68	DP 2x1-12V/12V-Tr	27 12 12-A	183
AK-T1/3+1-FM	79 00 05	49	CT-T3/24V-16A-FM	38 00 13	67	DP 2x1-150V/150V-Tr	27 04 04-A	184
AK-T1+2/3+0-FM	79 00 45	50	CT-T3/24V-25A-FM	38 00 14	68	DP 2x1-15V/15V-Tr	27 15 15-A	183
AK-T1+2/3+1-FM	79 00 15	50	CT-T3/275V-16A-FM	38 00 28	68	DP 2x1-24V/24V-0.3Ω-Tr	26 24 24	187
AK-T1+2+3/3+0-FM	79 00 50	51	CT-T3/275V-25A-FM	38 00 29	68	DP 2x1-24V/24V-Tr	27 24 24-A	183
AK-T1+2+3/3+1-FM	79 00 25	51	CT-T3/48V-16A-FM	38 00 16	67	DP 2x1-24V-SDSL-Tr	24 00 24	127
AntPro 5,8GHz-R-SMA	04 58 02	167	CT-T3/48V-25A-FM	38 00 17	68	DP 2x1-30V/30V-0.3Ω-Tr	26 30 30	187
AntPro 5,8GHz-SMA	04 58 00	167	CT-T3/60V-16A-FM	38 00 19	67	DP 2x1-30V/30V-Tr	27 30 30-A	184
AntPro 6GHz-N(f/f)	04 00 11	169	CT-T3/60V-25A-FM	38 00 20	68	DP 2x1-36V/36V-0.3Ω-Tr	26 36 36	187
AntPro 6GHz-N(m/f)	04 00 10	169	DAK 2x 16	17 01 10	248	DP 2x1-36V/36V-Tr	27 36 36-A	184
AntPro Koax-GSM-N/230	04 00 01	168	DataPro 2x1-SDSL-Tr	24 00 18	127	DP 2x1-48V/48V-Tr	27 48 48-A	184
AntPro Koax-GSM-N/230(f/f)	04 00 04	168	DataPro 4x1-SDSL-Tr	24 00 20	127	DP 2x1-60V/60V-0.3Ω-Tr	26 60 60	188
CPS-F 230/RJ45/RJ11	32 50 45	77	DataPro Koax-8V-BNC	54 43 46	165	DP 2x1-60V/60V-Tr	27 60 60-A	184
CT PV-T2/2+1/1000-FM	96 02 27	93	DataPro Koax-8V-BNC-75 Ohm	54 43 40	165	DP 2x1-6V/6V-Tr	27 06 06-A	183
CT PV-T2/2+1/600-FM	96 02 25	93	DataPro Z-12V/12V	22 12 12	192	DP 2x1-80V/80V-Tr	27 80 80-A	184
CT PV-T2/2+GDT/1000-FM	96 02 31	94	DataPro Z-15V/15V	22 15 15	192	DP 2x1-RLC/50V-Tr	28 70 50	189
CT PV-T2/2+GDT/600-FM	96 02 29	94	DataPro Z-24V/24V	22 24 24	192	DP 2x1-RLC-Tr	27 00 00	189
CT PV-T2/2-0/1000-FM	96 02 23	93	DataPro Z-30V/30V	22 30 30	192	DP 2x8-36V/36V-Tr/GO	27 90 00	191
CT PV-T2/2-0/600-FM	96 02 21	93	DataPro Z-36V/36V	22 36 36	193	DP 2x8-36V/36V-Tr/GU	27 90 01	191
CT PV-T2-1000-M	96 02 47	94	DataPro Z-48V/48V	22 48 48	193	DP 2x8RJ45-19"	19 40 23	147
CT PV-T2-1000-MS	96 02 50	94	DataPro Z-60V/60V	22 60 60	193	DP 3x1-12V/12V-Tr	28 12 12-A	185
CT PV-T2-600-M	96 02 46	94	DataPro-TAE/NFN-aP	24 00 04	149	DP 3x1-150V/150V-Tr	28 04 04-A	186
CT PV-T2-GDT-M	96 02 48	94	DP 10LSA-PTC-110	24 01 42	160	DP 3x1-15V/15V-Tr	28 15 15-A	185
CT-T1/0+1-FS-FM	96 02 33	13	DP 10LSA-PTC-12V	24 00 26	160	DP 3x1-24V/24V-Tr	28 24 24-A	185
CT-T1/1+0-350-FM	96 02 17	13	DP 10LSA-PTC-24V	24 00 28	160	DP 3x1-30V/30V-Tr	28 30 30-A	185
CT-T1/1+1-350-FM	96 02 15	13	DP 1LSA-110	24 00 39	155	DP 3x1-36V/36V-Tr	28 36 36-A	186
CT-T1/2+0-350-FM	96 02 13	12	DP 1LSA-110-PTC	24 00 46	157	DP 3x1-48V/48V-Tr	28 48 48-A	186
CT-T1/2+1-350-FM	96 02 11	12	DP 1LSA-12	24 00 32	154	DP 3x1-60V/60V-Tr	28 60 60-A	186
CT-T1/3+0-350-FM	96 02 09	12	DP 1LSA-12-PTC	24 00 41	156	DP 3x8RJ45-19"	19 40 33	147
CT-T1/3+1-350-FM	96 02 07	12	DP 1LSA-15	24 00 33	154	DP 4x8RJ45-19"	19 40 43	147
CT-T1+2/1+0-350-FM	96 00 11	15	DP 1LSA-24	24 00 34	154	DP 5x8RJ45-19"	19 40 53	148
CT-T1+2/1+1-350-FM	96 00 09	15	DP 1LSA-24-PTC	24 00 43	156	DP 6x8RJ45-19"	19 40 63	148
CT-T1+2/2+0-350-FM	96 00 07	14	DP 1LSA-48-PTC	24 00 44	157	DP 8xRJ45-6V-WG	19 40 50	146
CT-T1+2/2+1-350-FM	96 00 05	14	DP 1LSA-5	24 00 31	154	DP 8xRJ45-6x6V/2x48V-WG	19 40 51	146
CT-T1+2/3+0-350-FM	96 00 03	14	DP 1LSA-5-PTC	24 00 40	156	DP FME-AD	16 05 20	167
CT-T1+2/3+1-350-FM	96 00 01	14	DP 1LSA-60	24 00 38	155	DP Koax 7/16	10 10 00	170
CT-T1+2+3/1+0-350-FM	96 04 21	17	DP 1LSA-60-PTC	24 00 45	157	DP Koax 7/16 (f/f)	10 10 01	170
CT-T1+2+3/1+1-350-FM	96 04 17	17	DP 1LSA-C12FS-PTC	24 00 64	158	DP Koax BNC 500hm	54 43 30	166
CT-T1+2+3/2+0-350-FM	96 04 09	16	DP 1LSA-C15FS-PTC	24 00 65	158	DP RJ11/RJ12-48V-Tr	23 90 06	144
CT-T1+2+3/2+1-350-FM	96 04 13	16	DP 1LSA-C24FS-PTC	24 00 66	158	DP RJ45 f/f	24 00 11	144
CT-T1+2+3/3+0-350-FM	96 04 05	16	DP 1LSA-C48FS-PTC	24 00 61	159	DP RJ45-48V-Tr	23 90 00	143
CT-T1+2+3/3+1-350-FM	96 04 01	16	DP 1LSA-C5FS-PTC	24 00 63	158	DP RJ45-CAT6-48V-Tr	24 00 05	143
CT-T1+2+3-350-M	96 04 25	17	DP 1LSA-C60FS-PTC	24 00 62	159	DP RS 232/422/485-9P	24 00 60	149
CT-T1+2-350-M	96 02 36	15	DP 1LSA-T110FS-PTC	24 00 48	157	DP RS485-Tr	27 04 85	126
CT-T1-350-M	96 02 37	13	DP 1LSA-TK180FS	24 00 49	159	DP-SAT-EB5	17 01 80	171
CT-T1-NPE-M	96 02 38	13	DP 1x8RJ45-19"	19 40 13	147	DP-SAT-F-5...2500MHz	21 00 10	171
CT-T3/120V-16A-FM	38 00 22	67	DP 1xRJ45-PoE-Alu	24 00 21	145	DP-SMA-m/f	54 43 57	166



Product name	Art.-No.	Page	Product name	Art.-No.	Page	Product name	Art.-No.	Page
EL-T2/0+1-NPE	38 81 98	60	EnerPro 24V-Tr	24 24 00	82	EP D TN 48V/25A-FM	38 05 58	72
EL-T2/1+0-130-FM	38 81 85	58	EnerPro 280Tr/Pk	38 20 29	65	EP D TN 60V/16A/FM	38 05 57	71
EL-T2/1+0-275-FM	38 81 86	59	EnerPro 282Tr-M/Pk	38 20 45	65	EP D TN 60V/25A-FM	38 05 65	73
EL-T2/1+0-350-FM	38 81 87	59	EnerPro 284Tr-M/Pk	38 20 43	66	EP D TNC 275/FM	38 05 25	69
EL-T2/1+0-440-FM	38 81 88	59	EnerPro 36V-6A/LED	24 36 02	80	EP D TNS 275/FM	38 05 31	69
EL-T2/1+0-550-FM	38 81 89	59	EnerPro 36V-Tr	24 36 00	82	EP D TT 275/FM	38 05 36	69
EL-T2/1+0-750-FM	38 81 90	60	EnerPro 48V/100A-Tr/Pk	38 20 71	79	EP D TT1+1 275/FM	38 05 39	69
EL-T2/1+0-75-FM	38 81 84	58	EnerPro 48V-Tr	24 48 00	82	EP D TT2+1 275/FM	38 05 41	70
EL-T2/1+1-130-FM	38 81 71	57	EnerPro 60V/100A-Tr/Pk	38 20 76	79	EPF 230/400V/100A-E	25 31 40	181
EL-T2/1+1-275-FM	38 81 72	57	EnerPro 60V-Tr	24 60 00	83	EPF 230/400V/16A-W	25 30 45	180
EL-T2/1+1-350-FM	38 81 73	58	EnerPro 65V/12A-Tr/FM	29 60 02	231	EPF 230/400V/200A-E	25 31 60	181
EL-T2/1+1-440-FM	38 81 74	58	EnerPro 65V/20A-Tr/FM	29 60 11	231	EPF 230/400V/25A-W	25 30 80	180
EL-T2/2+0-130-FM	38 81 57	56	EnerPro 802Tr/Pk	39 50 05	96	EPF 230/400V/35A-W	25 31 00	180
EL-T2/2+0-275-FM	38 81 58	56	EP 1002/20kA-Tr	39 50 16	96	EPF 230/400V/63A-E	25 31 30	181
EL-T2/2+0-350-FM	38 81 59	57	EP 1003Tr	39 50 03	95	EPF 230V/16A-S	25 30 20	178
EL-T2/2+0-440-FM	38 81 60	57	EP 12V-20A/LED	24 12 03	81	EPF 230V/16A-Tr2-FM	25 30 09	177
EL-T2/2+1-130-FM	38 81 43	55	EP 24V-20A/LED	24 24 03	81	EPF 230V/16A-W	25 30 25	179
EL-T2/2+1-275-FM	38 81 44	55	EP 36V-20A/LED	24 36 03	81	EPF 230V/25A-Tr2-FM	25 30 11	177
EL-T2/2+1-350-FM	38 81 45	55	EP 48V-20A/LED	24 48 03	81	EPF 230V/35A-S	25 30 85	179
EL-T2/2+1-440-FM	38 81 46	56	EP 802/20kA-Tr	39 50 14	96	EPF 48V/16A-S	25 30 19	178
EL-T2/2+1-550-FM	38 81 47	56	EP 803Tr	39 50 26	95	EPF 48V/25A-S	25 30 53	178
EL-T2/2+1-75-FM	38 81 42	55	EP C IT 2P/FM	38 15 01	64	EPF 60V/16A-S	25 30 22	178
EL-T2/3+0-130-FM	38 81 29	54	EP C IT 3P/FM	38 15 11	64	EPS T1+2/3+1-320-12.5-FM	38 07 01	45
EL-T2/3+0-275-FM	38 81 30	54	EP C TN 275/FM	38 12 48	63	EPS T1+2/4+0-320-12.5-FM	38 07 03	45
EL-T2/3+0-350-FM	38 81 31	54	EP C TN 275-D	38 12 52	63	EP-T2/220VDC-16A-FM	38 06 11	84
EL-T2/3+0-440-FM	38 81 32	54	EP C TN 350/FM	38 55 50	63	EP-T3/230 KM-10kA	36 20 41	76
EL-T2/3+1-130-FM	38 81 15	53	EP C TN 75/FM	38 14 05	63	EP-T3/230 KM-10kA-v	36 20 43	76
EL-T2/3+1-275-FM	38 81 16	53	EP C TNC 275/FM	38 11 77	61	EP-T3/230 KM-20kA	36 20 42	76
EL-T2/3+1-350-FM	38 81 17	53	EP C TNC 350/FM	38 55 70	61	EP-T3/230 KM-20kA-v	36 20 44	76
EL-T2/3+1-440-FM	38 81 18	53	EP C TNS 275/FM	38 11 79	61	EP-T3/230 SDU	36 20 40	77
EL-T2/4+0-130-FM	38 81 01	52	EP C TNS 350/FM	38 55 90	61	Erdbrücke	17 00 80	127
EL-T2/4+0-275-FM	38 81 02	52	EP C TT 275/FM	38 11 81	62	Fuse Combiner Box	80 01 72	246
EL-T2/4+0-350-FM	38 81 03	52	EP C TT 350/FM	38 56 10	62	GAK 1x1 T1+T2 1000V-FM	80 04 45	242
EL-T2/4+0-440-FM	38 81 04	52	EP C TT1+1 275/FM	38 11 83	62	GAK 1x12 T1+T2 1000V-FM	80 04 54	242
EL-T2-130-M	38 80 01	60	EP C TT1+1 350/FM	38 11 91	62	GAK 1x2 T1+T2 1000V-DSK-FM	80 04 44	239
EL-T2-275-M	38 80 02	60	EP CV 2P 100V/63A/FM	38 20 89	230	GAK 1x3 T1+T2 1000V-DSK-FM	80 04 47	240
EL-T2-350-M	38 80 03	60	EP CV 2P 100V/63A/FM-LED	38 20 87	230	GAK 1x6 T1+T2 1000V-FM	80 04 51	242
EL-T2-440-M	38 80 04	60	EP CV 2P 65V/63A/FM	38 20 79	230	GAK 2+2/2+2/2xT1+T2 1000V-FM	80 01 54	244
EL-T2-550-M	38 80 05	60	EP CV 2P 65V/63A/FM-LED	38 20 83	230	GAK 2+2/2+2/2xT1+T2 800V-FM	80 01 31	237
EL-T2-750-M	38 80 06	60	EP D IT 2P/FM	38 05 71	70	GAK 2+2/2+2/2xT2 1000V-FM	80 01 23	237
EL-T2-75-M	38 80 00	60	EP D TN 120V/16A/FM	38 05 60	71	GAK 2+2/2+2/2xT2 800V-FM	80 01 21	237
EL-T2-NPE-M	38 80 07	60	EP D TN 120V/25A-FM	38 05 67	73	GAK 2x1 T1+T2 1000V-FM	80 04 46	243
E-Membran M12	17 01 40	248	EP D TN 230V/16A/FM	38 05 63	72	GAK 2x2 1000V/30A	80 01 67	246
EnerPro 1002Tr	39 50 02	96	EP D TN 230V/25A-FM	38 05 69	73	GAK 2x2 T1+T2 1000V-DSK-FM	80 04 43	239
EnerPro 12V-6A/LED	24 12 02	80	EP D TN 24V/16A/FM	38 05 51	71	GAK 2x3 T1+T2 1000V-DSK-FM	80 04 48	240
EnerPro 12V-Tr	24 12 00	82	EP D TN 24V/25A-FM	38 05 55	72	GAK 2x3 T1+T2 1000V-FM	80 04 52	243
EnerPro 150Tr/Pk	38 20 25	66	EP D TN 275/FM	38 12 55	72	GAK 2x4 T1+T2 1000V-FM	80 04 53	243
EnerPro 220Tr/20kA/PK	38 20 23	74	EP D TN 275V/25A-FM	38 05 48	73	GAK 2x5 T1+T2 1000V-DSK-FM	80 04 50	241
EnerPro 24V-6A/LED	24 24 02	80	EP D TN 48V/16A/FM	38 05 54	71			



# PRODUCT REGISTER

## ALPHABETICAL

Product name	Art.-No.	Page	Product name	Art.-No.	Page	Product name	Art.-No.	Page
GAK 3x1/3x1/3xT1+T2 1000V-FM	80 01 33	238	IP BC 60/FM-350 2kV	55 05 23	43	M10-Stoßstromgenerator	87 01 10	202
GAK 3x2 T1+T2 1000V-DSK-FM	80 04 42	239	IP BC 60/FM-440	55 05 41	43	MC6000	87 01 60	201
GAK 4x2 T1+T2 1000V-DSK-FM	80 04 41	239	IP BC TN 25/50/FM	38 12 39	41	MP 1x2 24V-170-HF ST	97 10 57	124
GAK 4x3 T1+T2 1000V-DSK-FM	80 04 49	240	IP BC TN 25/50/FM-350	38 54 30	41	MP 1x2 24V-HF ST	97 10 53	123
GAK 4x3/4xT1+T2 1000V-FM	80 01 64	238	IP BC TN 60/100/FM	38 12 35	41	MP 1x2 5V-170-HF ST	97 10 56	124
GAK 5x1 T1+T2 1000V-FM	80 04 55	241	IP BC TN 60/100/FM-350	38 54 10	41	MP 1x2 5V-HF ST	97 10 52	123
GAK 6x1/6x1/6xT1+T2 1000V-FM	80 01 35	238	IP BC TNC 25/75/FM	38 12 19	39	MP 1x2 GDT ST	97 00 10	111
GAK 6x2 T1+T2 1000V-DSK-FM	80 04 40	239	IP BC TNC 25/75/FM-350	38 53 10	39	MP 1x2 GDT+12V-Ad-Ad ST	97 00 19	113
GAK 8x2/8x2/8xT1+T2 1000V-FM	80 01 56	238	IP BC TNC 60/100/FM	38 11 43	39	MP 1x2 GDT+12V-Ad-Ad-FM	97 00 57	115
GAK 9x1/9x1/9xT1+T2 1000V-FM	80 01 80	238	IP BC TNC 60/100/FM-350	38 52 90	39	MP 1x2 GDT+12V-Ad-Ad-Pg ST	97 00 47	121
GAK AC-3 T1+T2-FM	80 01 84	245	IP BC TNS 25/100/FM	38 12 23	37	MP 1x2 GDT+12V-Ad-Pg ST	97 00 33	117
GDT Adapter ADE/FGH	87 00 60	199	IP BC TNS 25/100/FM-350	38 53 50	37	MP 1x2 GDT+170V-Ad-Ad ST	97 00 24	114
H35	87 00 10	199	IP BC TNS 60/100/FM	38 11 48	37	MP 1x2 GDT+170V-Ad-Ad-Pg ST	97 00 52	121
H45	16 02 00	199	IP BC TNS 60/100/FM-350	38 53 30	37	MP 1x2 GDT+170V-Ad-Pg ST	97 00 38	118
H65	87 01 50	199	IP BC TT 25/100/FM	38 12 27	38	MP 1x2 GDT+24V-Ad-Ad ST	97 00 20	113
HSCS-100-FM	48 78 07	213	IP BC TT 25/100/FM-350	38 53 90	38	MP 1x2 GDT+24V-Ad-Ad-FM	97 00 58	115
HSCS-500-FM	48 78 08	213	IP BC TT 60/100/FM	38 11 54	38	MP 1x2 GDT+24V-Ad-Ad-Pg ST	97 00 48	121
IF1-10-W	82 30 10	218	IP BC TT 60/100/FM-350	38 53 70	38	MP 1x2 GDT+24V-Ad-Pg ST	97 00 34	117
IF1-16-W	82 30 12	218	IP BC TT 60/100-LED/FM	38 11 63	44	MP 1x2 GDT+36V-Ad-Ad ST	97 00 21	113
IF1-18-W	82 30 20	218	IP BC TT1+1 25/100/FM	38 12 31	40	MP 1x2 GDT+36V-Ad-Ad-FM	97 00 59	115
IF1-19.8-W	82 30 24	218	IP BC TT1+1 25/100/FM-350	38 54 70	40	MP 1x2 GDT+36V-Ad-Ad-Pg ST	97 00 49	121
IF1-22.2-W	82 30 25	218	IP BC TT1+1 60/100/FM	38 11 58	40	MP 1x2 GDT+36V-Ad-Pg ST	97 00 35	117
IF1-22-W	82 30 11	218	IP BC TT1+1 60/100/FM-350	38 54 50	40	MP 1x2 GDT+48V-Ad-Ad ST	97 00 22	114
IF1-23-W	82 30 19	218	IsoProData 150V/150V-Tr	27 03 03	182	MP 1x2 GDT+48V-Ad-Ad-Pg ST	97 00 50	121
IF1-28.6-W	82 30 26	218	IsoProData-Tr	27 30 02	128	MP 1x2 GDT+48V-Ad-Pg ST	97 00 36	118
IF1-32-W	82 30 27	218	K1/150	49 51 06	214	MP 1x2 GDT+5V-Ad-Ad ST	97 00 18	113
IF1-39-W	82 30 28	218	K1/300	49 51 08	214	MP 1x2 GDT+5V-Ad-Ad-Pg ST	97 00 46	121
IF1-42-W	82 30 21	218	K1/600	49 51 11	214	MP 1x2 GDT+5V-Ad-Pg ST	97 00 32	117
IF1-52-W	82 30 22	218	KA 1TE-1/2	17 00 15	97	MP 1x2 GDT+60V-Ad-Ad ST	97 00 23	114
IF3-16-F	82 30 17	218	KA 1TE-1/3	17 00 13	97	MP 1x2 GDT+60V-Ad-Ad-Pg ST	97 00 51	121
IF3-18-F	82 30 15	218	KA 1TE-1/4	17 00 25	97	MP 1x2 GDT+60V-Ad-Pg ST	97 00 37	118
IF3-22-F	82 30 16	218	KA 1TE-1/6	17 00 31	97	MP 2x2 24V-170-HF ST	97 10 55	124
IF3-25-F	82 30 18	218	KA 1TE-1/8	17 00 42	97	MP 2x2 24V-HF ST	97 10 51	123
IP B 25/FM	55 05 00	36	KA 2TE-1/3	17 00 35	97	MP 2x2 5V-170-HF ST	97 10 54	124
IP B 60/FM	55 04 95	36	KA 2TE-1/4	17 00 41	97	MP 2x2 5V-HF ST	97 10 50	123
IP B TN 25/50/FM	38 12 37	36	Kalibrierung H35/H45/H65	87 01 40	199	MP 2x2 GDT ST	97 00 07	111
IP B TN 60/100/FM	38 12 33	36	LC 1	87 00 05	98	MP 2x2 GDT ST-350	97 00 08	111
IP B TNC 25/75/FM	38 12 17	35	LSA 2/10 AD	24 01 09	161	MP 2x2 GDT+12V-Ad-Ad ST	97 00 12	112
IP B TNC 60/100/FM	38 11 41	35	LSA 2/10 KS-120	24 01 36	161	MP 2x2 GDT+12V-Ad-Ad-Pg ST	97 00 40	119
IP B TNS 25/100/FM	38 12 21	34	LSA 2/10 KSR	24 01 08	161	MP 2x2 GDT+12V-Ad-Pg ST	97 00 26	116
IP B TNS 60/100/FM	38 11 46	34	LSA 2/10-AN	24 01 00	161	MP 2x2 GDT+170V-Ad-Ad ST	97 00 17	113
IP B TT 25/100/FM	38 12 25	34	LSA 2/10-ER38-rot	24 01 04	161	MP 2x2 GDT+170V-Ad-Ad-Pg ST	97 00 45	120
IP B TT 60/100/FM	38 11 51	34	LSA 2/10-ES	24 01 33	161	MP 2x2 GDT+170V-Ad-Pg ST	97 00 31	117
IP B TT1+1 25/50/FM	38 12 29	35	LSA 2/10-MW10-25/22	24 01 10	161	MP 2x2 GDT+24V-Ad-Ad ST	97 00 13	112
IP B TT1+1 60/100/FM	38 11 56	35	LSA 2/10-TR	24 01 02	161	MP 2x2 GDT+24V-Ad-Ad-Pg ST	97 00 41	119
IP BC 25/FM	37 38 26	42	LSA DIN ADAPT	24 01 37	161	MP 2x2 GDT+24V-Ad-Pg ST	97 00 27	116
IP BC 25/FM-350 2kV	55 05 27	43	LT ZP ST T1+2+3/3+1-275-12.5kA	38 16 81	48	MP 2x2 GDT+36V-Ad-Ad ST	97 00 14	112
IP BC 60/FM	55 05 18	42	LT ZP ST T1+2+3/3+1-275-7.5kA	38 16 82	48	MP 2x2 GDT+36V-Ad-Ad-Pg ST	97 00 42	119
IP BC 60/FM-350	55 05 21	42				MP 2x2 GDT+36V-Ad-Pg ST	97 00 28	116



Product name	Art.-No.	Page	Product name	Art.-No.	Page	Product name	Art.-No.	Page
MP 2x2 GDT+48V-Ad-Ad ST	97 00 15	113	MP RK GDT	97 10 03	128	PP B TT1+1 50/100/FM	38 11 31	19
MP 2x2 GDT+48V-Ad-Ad-Pg ST	97 00 43	120	MP RK GDT+12V-Ad-Ad	97 10 05	130	PP B TT2+1 50/100/FM	37 39 17	19
MP 2x2 GDT+48V-Ad-Pg ST	97 00 29	117	MP RK GDT+12V-Ad-Ad-Pg	97 10 19	129	PP BC 50-440/FM	37 45 01	25
MP 2x2 GDT+5V-Ad-Ad ST	97 00 11	112	MP RK GDT+12V-Ad-Pg	97 10 12	131	PP BC TN 25/50/FM	38 12 13	24
MP 2x2 GDT+5V-Ad-Ad-Pg ST	97 00 39	119	MP RK GDT+170V-Ad-Ad	97 10 10	131	PP BC TN 25/50/FM-350	38 51 90	24
MP 2x2 GDT+5V-Ad-Pg ST	97 00 25	116	MP RK GDT+170V-Ad-Ad-Pg	97 10 24	130	PP BC TNC 25/75/FM	37 39 82	23
MP 2x2 GDT+60V-Ad-Ad ST	97 00 16	113	MP RK GDT+170V-Ad-Pg	97 10 17	132	PP BC TNC 25/75/FM-350	38 51 30	23
MP 2x2 GDT+60V-Ad-Ad-Pg ST	97 00 44	120	MP RK GDT+24V-Ad-Ad	97 10 06	130	PP BC TNC 440/FM	37 39 83	24
MP 2x2 GDT+60V-Ad-Ad-Pg ST	97 00 30	117	MP RK GDT+24V-Ad-Ad-Pg	97 10 20	129	PP BC TNC 50-400/690/FM	37 45 05	25
MP Base 1x2	97 00 97	111	MP RK GDT+24V-Ad-Pg	97 10 13	131	PP BC TNS 25/100/FM	37 39 52	22
MP Base 1x2 GDT	97 00 98	111	MP RK GDT+36V-Ad-Ad	97 10 07	130	PP BC TNS 25/100/FM-350	38 51 50	22
MP Base 1x2 GND	97 00 94	111	MP RK GDT+36V-Ad-Ad-Pg	97 10 21	129	PP BC TT 25/100/FM	37 39 22	22
MP Base 1x2-R	97 00 95	114	MP RK GDT+36V-Ad-Pg	97 10 14	131	PP BC TT 25/100/FM-350	38 51 70	22
MP Base 1x2-R GDT	97 00 96	114	MP RK GDT+48V-Ad-Ad	97 10 08	131	PP BC TT1+1 25/100/FM	38 11 33	23
MP Base 1x2-R GDT HF	97 01 03	123	MP RK GDT+48V-Ad-Ad-Pg	97 10 22	130	PP BC TT1+1 25/100/FM-350	38 52 10	23
MP Base 1x2-R GND	97 00 93	114	MP RK GDT+48V-Ad-Pg	97 10 15	132	PP BCD 25-350/FM	37 38 89	29
MP Base 1x2-R GND HF	97 01 04	123	MP RK GDT+5V-Ad-Ad	97 10 04	130	PP BCD 27kA/FM	37 38 65	30
MP Base 1x2-R HF	97 01 02	123	MP RK GDT+5V-Ad-Ad-Pg	97 10 18	129	PP BCD 27kA/FM-350	37 38 68	30
MP Base 1x2-R-FM	97 00 06	115	MP RK GDT+5V-Ad-Pg	97 10 11	131	PP BCD IT 2P 25/50-440/FM	37 39 55	29
MP Base 2x2	97 00 03	111	MP RK GDT+60V-Ad-Ad	97 10 09	131	PP BCD IT-NO 25/75/FM	37 39 85	28
MP Base 2x2 GDT	97 00 04	111	MP RK GDT+60V-Ad-Ad-Pg	97 10 23	130	PP BCD TN 25/50/FM	38 12 15	27
MP Base 2x2 GND	97 00 92	111	MP RK GDT+60V-Ad-Pg	97 10 16	132	PP BCD TN 25/50/FM-350	38 50 70	27
MP Base 2x2-R	97 00 00	112	MP RK-AB	97 10 02	132	PP BCD TN 25/50/LED/FM	37 12 02	32
MP Base 2x2-R GDT	97 00 01	112	MSR-M20-24V	97 20 11	137	PP BCD TN 25/50/LED/FM-350	38 51 10	32
MP Base 2x2-R GDT HF	97 01 00	123	MTH 230	95 15 01	153	PP BCD TN 25/50-LED-M/FM	38 12 09	33
MP Base 2x2-R GND	97 00 91	116	MTH 90	95 15 00	153	PP BCD TNC 25/75/FM	37 39 92	27
MP Base 2x2-R GND HF	97 01 01	123	MTL 230	95 15 03	153	PP BCD TNC 25/75/FM-350	38 50 10	27
MP Base 2x2-R HF	97 00 99	123	MTL 90	95 15 02	153	PP BCD TNC 75/LED/FM	37 39 57	32
MP RK 12V-Ad-Ad	97 10 26	133	MW-AntPro	17 01 66	168	PP BCD TNS 25/100/FM	37 39 62	26
MP RK 12V-Ad-Ad-Pg	97 10 40	135	NM 220V/20kA/Pk	36 20 23	75	PP BCD TNS 25/100/FM-350	38 50 30	26
MP RK 12V-Ad-Pg	97 10 33	134	NM 220V/5kA	36 05 22	75	PP BCD TT 100/LED/FM	37 39 59	32
MP RK 170V-Ad-Ad	97 10 31	134	PLPro-40A-iV	55 04 40	229	PP BCD TT 25/100/FM	37 39 32	26
MP RK 170V-Ad-Ad-Pg	97 10 45	136	PLPro-40A-iV HSCS-500-FM	55 04 39	229	PP BCD TT 25/100/FM-350	38 50 50	26
MP RK 170V-Ad-Pg	97 10 38	135	PLPro-80A-iV	55 04 41	229	PP BCD TT1+1 25/100/FM	38 11 35	28
MP RK 24V-Ad-Ad	97 10 27	133	PowerPro B-Tr/50kA/Pk	37 38 40	21	PP BCD TT1+1 25/100/FM-350	38 50 90	28
MP RK 24V-Ad-Ad-Pg	97 10 41	135	PP B 25-760/FM	37 45 21	21	PP BCD TT2+1 25/100/FM	37 39 36	28
MP RK 24V-Ad-Pg	97 10 34	134	PP B 50-350/FM	37 38 85	21	PP BCD-Tr/25kA/FM-350	37 38 62	29
MP RK 36V-Ad-Ad	97 10 28	133	PP B 50-520/FM	37 70 01	21	PP BCD-Tr/25kA/Pk	37 38 60	29
MP RK 36V-Ad-Ad-Pg	97 10 42	135	PP B IT 50/100/FM	37 39 19	21	PP BCD-Tr/25kA-LED/FM	37 38 49	33
MP RK 36V-Ad-Pg	97 10 35	134	PP B TN 440/FM	37 39 46	20	PP BCD-Tr/25kA-VA/FM	37 38 61	31
MP RK 48V-Ad-Ad	97 10 29	134	PP B TN 50/100/FM	38 12 11	20	PP PV 1000/FM	37 44 03	92
MP RK 48V-Ad-Ad-Pg	97 10 43	136	PP B TNC 440/FM	37 39 65	20	PP PV 1000-12,5kA-FM	37 44 05	92
MP RK 48V-Ad-Pg	97 10 36	135	PP B TNC 50/100/FM	37 39 72	19	PP PV 800/FM	37 44 01	92
MP RK 5V-Ad-Ad	97 10 25	133	PP B TNC 50/100/FM-350	37 41 15	20	Prüfadapter ADE/E	87 00 70	199
MP RK 5V-Ad-Ad-Pg	97 10 39	135	PP B TNS 440/FM	37 39 44	18	PV AB 1000 1M	80 05 70	247
MP RK 5V-Ad-Pg	97 10 32	134	PP B TNS 50/100/FM	37 39 42	18	PV AB 1000 2M	80 05 80	247
MP RK 60V-Ad-Ad	97 10 30	134	PP B TNS 50/100/FM-350	37 41 25	18	PV AC-DC 1.1-1000-FM	80 01 81	244
MP RK 60V-Ad-Ad-Pg	97 10 44	136	PP B TT 50/100/FM	37 39 12	18	PV AC-DC 1.1-800-FM	80 01 43	244
MP RK 60V-Ad-Pg	97 10 37	135	PP B TT 50/100/FM-350	37 41 35	19	PV AC-DC 1.2-800-FM	80 01 82	244



# PRODUCT REGISTER

## ALPHABETICAL

Product name	Art.-No.	Page
PV AC-DC 3.1-1000-FM	80 01 45	244
PV AC-DC 3.3-1000-FM	80 01 83	244
PV DC 1/1 1xT1+2 1000V/ MC4-FM	80 01 79	245
PV DC 2.800-2-FM	80 01 41	237
PV DC 3.800-3-FM	80 01 76	238
PV DC 3.800-3-S2-FM	80 01 77	238
PV DC 8.800-8-FM	80 01 78	238
SGO 350	47 22 13	211
SGO 350 QA	47 21 11	212
SGO 70	47 21 17	211
SGO 70 QA	47 21 04	212
SP BC NPE 100/FM	37 38 24	46
ST-Si/10A	17 01 53	248
ST-Si/12A	17 01 54	248
ST-Si/20A	17 01 56	248
ST-Si/4A	17 01 51	248
ST-Si/8A	17 01 52	248
TA 100C	48 78 14	210
TA 500C	48 78 27	210
TC 100 A	48 78 30	214
TC 100 A-K1/300	49 51 07	214
TC 100 A-K1/500	49 51 00	214
TC 500 A	48 78 50	214
TC Acryl hood	49 50 80	215
TelPro LSA 2/10-2E 8x6	24 01 06	151
TelPro LSA 2/10-3E 8x13	24 01 18	152

Product name	Art.-No.	Page
TelPro LSA 2/10-3EH230E-10kA	24 01 19	152
TelPro LSA-2EH230-10kA	24 01 13	151
TelPro LSA-2EH230F-10kA	24 01 14	151
TelPro LSA-2EH350-10kA	24 01 16	151
TelPro LSA-2EH90-10kA	24 01 17	151
TelPro LSA-2EL230-20kA	24 01 15	151
TelPro LSA-2EL350-20kA	24 01 56	151
TelPro LSA-2EL90-20kA	24 01 54	151
TelPro LSA-3EH230F1E-10kA	24 01 23	152
TelPro LSA-3EH90E-10kA	24 01 26	152
TelPro LSA-3EH90F1E-10kA	24 01 27	152
TelPro LSA-3EL230E-20kA	24 01 24	152
TelPro LSA-3EL230F1E-20kA	24 01 25	152
TF 100Tr/Th-Pk	53 43 72	220
TF 2000Tr/Th-Pk	55 04 11	220
TF 500Tr/Th-Pk	53 43 85	220
TSF 100	44 90 69	209
TSF 100 H1	44 91 50	209
TSF 100-Tr	44 90 80	219
TSF 50	44 90 60	209
TSF 500	48 78 01	209
TSF 500-Tr	44 90 85	219
TSF 50-Tr	44 90 76	219
TSF-H1	44 91 75	209
UAS 230-Tr	35 10 30	97





# LEUTRON®

**SURGE PROTECTION FOR POWER SUPPLY SYSTEMS**

**SURGE PROTECTION FOR MEASURING SYSTEMS AND AUTOMATIC CONTROL DEVICES**

**SURGE PROTECTION FOR INFORMATION TECHNOLOGY AND TELEKOMMUNICATION**

**SURGE PROTECTION FOR TRANSMITTING AND RECEIVING SYSTEMS**

**EMV-FILTER WITH INTEGRATED SURGE PROTECTION**

**MONITORING**

**RARE-GAS-FILLED INSULATION SPARK GAPS**

**PROTECTIVE DEVICES FOR AC ARRESTING**

**SURGE PROTECTION OF PV SYSTEMS: GENERATOR CONNECTION BOXES**

**LEUTRON GMBH**

**LIGHTNING AND SURGE PROTECTION**

GAUSSSTRASSE 2

D-70771 LEINFELDEN-ECHTERDINGEN

GERMANY

T: +49-(0)711-94771-0

F: +49-(0)711-94771-70

INFO@LEUTRON.DE

WWW.LEUTRON.DE

WWW.LEUTRON.DE